



EUROPEAN MEDICINES AGENCY  
SCIENCE MEDICINES HEALTH

18 March 2022  
EMA-H-19984/03 Rev. 98  
Human Medicines Evaluation Division

## European Medicines Agency post-authorisation procedural advice for users of the centralised procedure

### **Important information regarding ending of Irish language derogation**

As of 1st January 2022, a derogation expires concerning the status of Irish as a working language of the EU Institutions.

This means that Irish will be the authentic language of Commission decisions on marketing authorisations, including the product information they contain, addressed to any marketing authorisation holder established in Ireland, unless they request a language waiver. This will also apply to post-authorisation decisions of the European Commission addressed to EU Member States, including the product information they contain, which will be translated into Irish together with the other official EU languages, for the following procedures: [Referrals](#), [Periodic safety update reports \(PSURs\)](#), [Post-authorisation safety studies \(PASS\)](#).

Companies should be aware that at a certain point in the future a more extensive use of the Irish language may be required.

Please see also: Irish language (EMA webpage) and [Guidance on Irish language derogation ending on 1 January 2022](#)

### **Important technical information**

As of 1<sup>st</sup> of November 2021, the registration of new sites and organisations for centrally-authorised [medicinal products](#) in [Organisation Management Service \(OMS\)](#) will become mandatory prior to the associated regulatory submissions to the Agency (e.g. transfer of the marketing authorisation, addition of a manufacturing site).

The EMA would like to emphasise the importance of these site/organisation registrations in OMS prior to pre- and post-authorisation submissions, in order to avoid any delay in the start of these procedures, as this would constitute a validation blocking issue.

Please see also: [SPOR Web UI \(europa.eu\)](#) and [Q&A on the mandatory use of OMS for CAPs](#)

This integrated version has been created for printing purposes only. Please refer to the individual question & answers as published in the post-authorisation guidance for access to the hyperlinked information.

**Official address** Domenico Scarlattilaan 6 • 1083 HS Amsterdam • The Netherlands

**Address for visits and deliveries** Refer to [www.ema.europa.eu/how-to-find-us](http://www.ema.europa.eu/how-to-find-us)

**Send us a question** Go to [www.ema.europa.eu/contact](http://www.ema.europa.eu/contact) **Telephone** +31 (0)88 781 6000

An agency of the European Union



Questions and answers are being updated continuously and will be marked by "NEW" or "Rev." with the relevant date upon publication.

This guidance document addresses a number of questions which marketing authorisation holders (MAHs) may have on post-authorisation procedures. It provides an overview of the Agency's position on issues, which are typically addressed in discussions or meetings with MAHs in the post-authorisation phase.

It will be updated regularly to reflect new developments, to include guidance on further post-authorisation procedures and to reflect the implementation of the new European legislation. Revised topics will be marked by "New" or "Rev" upon publication.

The Agency emphasises the importance of pre-submission meetings between MAHs and the EMA/(Co-) Rapporteur. The product team is available to address any questions MAHs may have regarding a particular upcoming post-authorisation applications. Where appropriate, a pre-submission meeting could be organised at the Agency in order to obtain further procedural and regulatory/legal advice.

This guidance information and fruitful pre-submission dialogue between MAHs and the Agency should enable MAHs to submit applications, which are in conformity with the legal and regulatory requirements and which can be validated and processed promptly.

In addition, MAHs are strongly recommended to inform the Agency and (Co-) Rapporteur of all upcoming post-authorisation submissions for the following 6-12 months, in order to allow optimal planning, identification of procedural issues and handling of overlapping applications.

**Note:**

It should be highlighted that this document has been produced for guidance only and should be read in conjunction with "The Rules governing Medicinal Products in the European Union, Volume 2, Notice to Applicants".

MAHs must in all cases comply with the requirements of EU Legislation. Provisions, which extend to Iceland, Liechtenstein and Norway by virtue of the EEA agreement, are outlined in the relevant sections of the text.

## Table of Contents

<b>1. Type IA Variations</b> .....	<b>14</b>
1.1. When shall I submit my Type IA/IA <sub>IN</sub> variation(s)? Rev. Dec 2016 .....	14
1.2. Can I group the submission of Type IA/IA <sub>IN</sub> variations? Can they be grouped with other types of variations? Rev. Sep 2014 .....	15
1.3. Is the (Co-) Rapporteur involved in the review of Type IA/IA <sub>IN</sub> variations? Rev. Aug 2014 .....	16
1.4. How shall I present and submit my Type IA/ IA <sub>IN</sub> Variation(s)? Rev. Mar 2022 .....	16
1.5. How shall my Type IA/IA <sub>IN</sub> variation be handled (timetable)? Rev. Oct 2012 .....	20
1.6. Can my Type IA/ IA <sub>IN</sub> be part of worksharing? Rev. Feb 2021 .....	20
1.7. What should I do in case of an unfavourable outcome for my Type IA/ IA <sub>IN</sub> variation(s)? Rev. July 2013 .....	21
1.8. What fee do I have to pay for a Type IA/ IA <sub>IN</sub> variation? Rev. Apr 2021.....	21
1.9. Do I have to submit mock-ups and specimens? Rev. July 2013 .....	22
1.10. What changes will trigger new EU number(s) (additional presentation(s))? Rev. Feb 2021 .....	22
1.11. How to obtain new EU sub-numbers for Type IA <sub>IN</sub> variation concerning an additional presentation (e.g. new pack-size)? Rev. Feb 2021 .....	23
1.12. When do I have to submit revised product information? In all languages? Rev. Apr 2021 .....	24
1.13. How and when will the updated product information Annexes become part of the Marketing Authorisation? Rev. Oct 2012 .....	25
1.14. What should be the date of revision of the text for Type IA Variations? New Oct 2010 .....	26
1.15. Who should I contact if I have a question when preparing my application or during the procedure? Rev. Feb 2021 .....	26
<b>2. Type IB variations</b> .....	<b>28</b>
2.1. What changes are considered Type IB variations? Rev. Oct 2013.....	28
2.2. Is the (Co-) Rapporteur involved in Type IB Variations? Rev. Feb 2019 .....	28
2.3. Can I group the submission of Type IB variations? Can they be grouped with other types of variations? Rev. Oct 2013 .....	29
2.4. How shall I present and submit my Type IB Variation? Rev. Mar 2022 .....	30
2.5. When shall I submit my Type IB Variation? Rev. Apr 2016.....	32
2.6. When do I need a linguistic review for changes in the product information? NEW Apr 2016 .....	33
2.7. How shall my Type IB variation be handled (timetable)? Rev. Apr 2016 .....	34
2.8. What fee do I have to pay for a Type IB Variation? Rev. Apr 2021 .....	36
2.9. Do I have to submit mock-ups and specimens? Rev. Apr 2016.....	36
2.10. How should I submit revised product information? In all languages? Rev. Apr 2021 ..	37
2.11. What changes will trigger new EU number(s) (additional presentation(s))? Rev. Feb 2021 .....	38
2.12. How to obtain new EU sub-numbers for a Type IB variation concerning an additional presentation (e.g. new pack-size)? Rev. Feb 2021 .....	39
2.13. How and when will the updated Annexes become part of the Marketing Authorisation? Rev. Oct 2012 .....	40

2.14. Who should I contact if I have a question when preparing my application or during the procedure? Rev. Feb 2021 ..... 41

**3. Type II variations ..... 42**

3.1. What changes considered Type II variations? Rev. Dec 2016 ..... 42

3.2. Do I need to notify the Agency of my intention to submit a Type II variation application? Rev. Feb 2019 ..... 42

3.3. Which Committee will take the lead in the assessment of a type II variation? NEW Dec 2019 ..... 43

3.4. Is the Co-Rapporteur involved in Type II Variations? Rev. Dec 2019 ..... 43

3.5. Is the PRAC Rapporteur involved in type II variations? Rev. Dec 2019 ..... 44

3.6. Can I group the submission of type II variations? Can they be grouped with other types of variations? Rev. Feb 2015 ..... 44

3.7. How shall I present my type II Variation application? Rev. Jul 2021 ..... 45

3.8. How shall I present my application for a new or modified therapeutic indication? Rev. Jul 2021 ..... 48

3.9. How and to whom shall I submit my Type II Variation application? Rev. Feb 2019 ..... 49

3.10. When shall I submit my type II variation? Rev. Dec 2019 ..... 49

3.11. How shall my Type II application be handled (timetable)? Rev. Feb 2019 ..... 51

3.12. How should parallel type II variations that affect the product information be handled? NEW Dec 2016 ..... 55

3.13. Which post-opinion steps apply to my type II variation and when can I implement the approved changes? Rev. May 2020 ..... 56

3.14. What fee do I have to pay for a type II variation? Rev. Apr 2021 ..... 60

3.15. Do I have to submit mock-ups and specimens? Rev. July 2013 ..... 60

3.16. When do I have to submit revised product information? In all languages? Rev. Mar 2022 ..... 61

3.17. What changes will trigger new EU number(s) (additional presentation(s))? Rev. Feb 2019 ..... 63

3.18. What is the procedure for assignment of new European Union sub-numbers for a type II variation concerning additional presentation(s)? NEW Nov 2012 ..... 64

3.19. Will there be any publication on the outcome of my type II Variation? Rev. Oct 2012 ..... 64

3.20. What aspects should I consider at time of submission of a type II variation if there are orphan medicinal products designated or authorised for a condition related to my proposed therapeutic indication? Rev. May 2020 ..... 64

3.21. Do I need to confirm the maintenance of my orphan designation when applying for a type II variation? Rev. Oct 2019 ..... 66

3.22. Can a non-orphan therapeutic indication be added to an already authorised orphan medicinal product? Rev. Feb 2019 ..... 67

3.23. Can a new indication based on less comprehensive data be added to an already authorised medicinal product? Rev. Feb 2019 ..... 67

3.24. Do I need to address any paediatric requirements in my type II variation application? Rev. Apr 2012 ..... 68

3.25. When will I get a PIP compliance statement? NEW Dec 2016 ..... 70

3.26. Who is my contact at the European Medicines Agency during a type II variation, including extension of indications? Rev. Mar 2022 ..... 71

3.27. Whom should I contact if I have a pre-submission question when preparing my type II variation application (non-clinical/clinical/RMP)? NEW Mar 2022 ..... 72

<b>4. Extension of marketing authorisation.....</b>	<b>73</b>
4.1. When will my variation application be considered a type II variation or an extension application? Rev. Nov 2016 .....	73
4.2. Extension applications – will my invented name changes? Rev. Aug 2014.....	74
4.3. Do I need to notify the Agency of my intention to submit an extension application? Rev. Jan 2021 .....	74
4.4. Is the (Co-) Rapporteur involved in Extension Applications? Rev. March 2013 .....	75
4.5. How shall I present my Extension Application? Rev. Feb 2022.....	75
4.6. What aspects should I consider at time of submission of an extension application if there are orphan medicinal products designated or authorised for a condition related to my proposed therapeutic indication? Rev. May 2020 .....	76
4.7. Do I need to confirm the maintenance of my orphan designation when applying for an extension application? Rev. Oct 2019 .....	78
4.8. Can a non-orphan therapeutic indication be added to an already authorised orphan medicinal product? NEW Mar 2016 .....	79
4.9. Can a new indication based on less comprehensive data be added to an already authorised medicinal product? NEW Nov 2016 .....	79
4.10. Can I group the submission of Extensions with other types of variations? Rev. Oct 2013 .....	80
4.11. How, when and to whom shall I submit my Extension Application? Rev. Feb 2019 ....	80
4.12. How shall my Extension Application be handled (timetable)? Rev. May 2020 .....	80
4.13. What fee do I have to pay for an Extension Application? Rev. Apr 2021.....	83
4.14. Do I have to submit mock-ups and specimens? Rev. July 2013 .....	84
4.15. When do I have to submit revised product information? In all languages? Rev. Mar 2022 .....	84
4.16. What is the procedure for assignment of new European Union sub-numbers for an extension including additional presentation(s)? New Nov 2012 .....	86
4.17. Will there be any publication on the outcome of my Extension application? Rev. Oct 2012 .....	86
4.18. Do I need to address any paediatric requirements in my extension application? Rev. Apr 2012 .....	87
4.19. Who should I contact if I have a question when preparing my application and during the procedure? Rev. Feb 2019 .....	89
<b>5. Grouping of variations.....</b>	<b>90</b>
5.1. What types of variations can be grouped? Rev. Oct 2013 .....	90
5.2. What groups of variations would be considered acceptable? Rev. Dec 2019 .....	91
5.3. How shall I present a grouped variations application? Rev. Aug 2020.....	96
5.4. What procedure number will be given to grouped variation applications? Rev. Oct 2020 .....	97
5.5. Can grouped variations be subject to a worksharing procedure? Rev. Oct 2010.....	98
5.6. How will grouped variation applications be handled (timetable)? What will be the outcome of the evaluation of a grouped variation application? Rev. May 2020 .....	98
5.7. How and when will the marketing authorisation be updated for grouped variations? Rev. July 2013.....	99
5.8. What fee do I have to pay for grouped variations? Rev. Apr 2021.....	100

<b>6. Worksharing of variations .....</b>	<b>101</b>
6.1. What is worksharing and what types of variations can be subject to worksharing? Rev. Oct 2013 .....	101
6.2. What variation(s) would be considered acceptable for worksharing? Rev. July 2013 ..	102
6.3. What pre-submission steps will apply to a worksharing procedure? Rev. Oct 2020....	103
6.4. How shall I present a variation application under worksharing? Rev. Mar 2022.....	104
6.5. How and to whom shall I submit my variation application under worksharing? Rev. Mar 2022 .....	105
6.6. What procedure number will be given to variation applications under worksharing? Rev. Oct 2020 .....	107
6.7. How will variation applications under worksharing be handled (timetable)? What will be the outcome of the evaluation of a variation application under worksharing? Rev. Feb. 2015 .....	108
6.8. How and when will the marketing authorisations be updated following a worksharing procedure? When can I implement the approved changes? Rev. Mar 2022 .....	109
6.9. What fee do I have to pay for variation applications under worksharing? Rev. Apr 2021 .....	112
6.10. When do I have to submit revised product information? In all languages? Rev. Apr 2021 .....	113
<b>7. Classification of changes .....</b>	<b>116</b>
7.1. Administrative changes .....	116
7.2. Quality changes .....	116
7.3. (Non-) Clinical changes .....	124
7.4. Editorial changes.....	131
<b>8. Pre-submission queries service .....</b>	<b>134</b>
8.1. What is the pre-submission queries service? Rev. Mar 2022.....	134
8.2. How should I send queries to the pre-submission queries service? Rev. Mar 2022 ....	134
8.3. How will my query be handles by the pre-submission queries service? .....	135
8.4. When can I expect to receive a response to my query? Rev. May 2020 .....	135
<b>9. Changing the (Invented) Name of a Centrally Authorised Medicinal Product.....</b>	<b>136</b>
9.1. Can I change the (Invented) Name of my CAP? Rev. Oct 2013.....	136
9.2. Is the Invented Name (IN) checking procedure mandatory for the new proposed IN? Rev. Oct 2013 .....	136
9.3. How shall I present my IN change application? Rev. Feb 2019 .....	137
9.4. Do I need to submit amended mock-ups/specimens with my variation? Rev. Oct 2013 .....	138
<b>10. Annual Re-assessment .....</b>	<b>139</b>
10.1. What is the annual re-assessment? Rev. Dec 2015 .....	139
10.2. Are the CHMP Co-Rapporteur and the PRAC involved in the assessment? Rev. Apr 2021 .....	139
10.3. How shall I present my annual re-assessment application? Rev. May 2020 .....	140
10.4. Can I submit a PSUR with my annual re-assessment application? Rev. Dec 2015....	142
10.5. Can I submit an RMP with my annual re-assessment application? Rev. Aug 2017 ...	142
10.6. When, how and to whom shall I submit my annual re-assessment application? Rev. Feb 2019 .....	142

10.7. How shall my annual re-assessment be handled (timetable)? Rev. Apr 2021 .....	142
10.8. What could be the outcome of my annual re-assessment? Rev. Dec 2015.....	143
10.9. Can I submit my annual re-assessment within the renewal? Rev. Dec 2015 .....	144
10.10. Do I have to pay fees for an annual re-assessment? .....	145
10.11. What impact do ongoing Variation(s) (Type IA/IB or Type II) have on the annual re-assessment? Rev. Dec 2015 .....	145
10.12. Do I have to submit mock-ups and specimens? Rev. Dec 2015.....	145
10.13. When do I have to submit (revised) product information? In all languages? Rev. Apr 2021 .....	145
10.14. Will there be any publication on the outcome of my annual re-assessment? Rev. Dec 2015 .....	147
10.15. Who should I contact if I have a question when preparing my application and during the procedure? Rev. Feb 2019 .....	147
<b>11. Renewal .....</b>	<b>148</b>
11.1. How long is my marketing authorisation valid for? Rev. Feb 2019 .....	148
11.2. When shall I submit my renewal application? Rev. May 2020 .....	148
11.3. How shall I present my renewal application? Rev. May 2020 .....	149
11.4. How and to whom shall I submit my renewal application? Rev. Feb 2019.....	154
11.5. How shall my renewal application be handled (timetable)? Rev. Aug 2016 .....	154
11.6. What fee do I have to pay for a renewal? Rev. Dec 2015 .....	155
11.7. Can other non-renewal specific changes be included in the renewal application? Rev. Dec 2015 .....	155
11.8. How to handle other ongoing variation applications during the renewal procedure and what impact may ongoing procedures have on the renewal procedure? Rev. Dec 2015 ....	156
11.9. Do I have to submit mock-ups and specimens? Rev. Aug 2017 .....	156
11.10. When do I have to submit revised product information? In all languages? Rev. Apr 2021 .....	157
11.11. When will the linguistic checking of the product information take place? Rev. Apr 2021 .....	158
11.12. What do I need to do if I do not want to renew the Marketing Authorisation of certain product presentations or the entire product? Rev. Feb 2019 .....	160
11.13. Will there be any publication on the outcome of my renewal application? Rev. Dec 2015 .....	160
11.14. Who should I contact if I have a question when preparing my application and during the procedure? Rev. Feb 2019 .....	161
<b>12. Annual renewal of conditional marketing authorisations.....</b>	<b>162</b>
12.1. How long is my conditional marketing authorisation valid? Rev. Feb 2019.....	162
12.2. When shall I submit my annual renewal application? Rev. Mar 2016 .....	162
12.3. How shall I present my annual renewal application? Rev. May 2020.....	163
12.4. How and to whom shall I submit my annual renewal application? Rev. Feb 2019 ....	166
12.5. How shall my annual renewal application be handled (timetable)? Rev. Mar 2016 ...	166
12.6. What fee do I have to pay for a renewal? NEW Mar 2013.....	167
12.7. Can other non-renewal specific changes be included in the annual renewal application? Rev. Mar 2016.....	167
12.8. How to handle other ongoing variation applications during the renewal procedure and what impact may ongoing procedures have on the renewal procedure? Rev. Mar 2016 ....	167

12.9. Do I have to submit mock-ups and specimens? Rev. Mar 2016.....	168
12.10. When do I have to submit revised product information? In all languages? Rev. Apr 2021 .....	168
12.11. When will the linguistic checking of the product information take place? Rev. Apr 2021 .....	169
12.12. What do I need to do if I do not want to renew the Marketing authorisation of certain product presentations or the entire product? Rev. Mar 2016.....	171
12.13. What do I need to do if all Specific Obligations have been completed? Rev. Feb 2019 .....	171
12.14. Will there be any publication on the outcome of my annual renewal application? Rev. Mar 2016 .....	172
12.15. Who should I contact if I have a question when preparing my application? Rev. Feb 2019 .....	172
<b>13. Post Authorisation Safety Study (PASS) .....</b>	<b>173</b>
13.1. What is a non-interventional imposed PASS? NEW Jul 2017 .....	173
13.2. Under which procedure should I submit my non-interventional imposed PASS? Rev. Apr 2021 .....	173
13.3. What if the results of a non-interventional imposed PASS make a variation necessary? NEW Jul 2017 .....	175
13.4. How shall I present my non-interventional imposed PASS and in which format? Rev. May 2020 .....	175
13.5. To whom should I submit my imposed non-interventional PASS? Rev. May 2020 ....	176
13.6. How do I submit a joint PASS? Rev. May 2020 .....	177
13.7. How will my non-interventional imposed PASS protocol be handled? Rev. Feb 2019	178
13.8. How will my imposed non-interventional PASS final study report be handled? Rev. Feb 2019 .....	180
13.9. How is the CHMP opinion / CMDh position structured and which annexes need to be translated? NEW Jul 2017 .....	183
13.10. How shall I implement the outcome of a non-interventional imposed PASS final study report procedure? NEW Jul 2017.....	188
13.11. When should I register my studies in the EU PAS Register? NEW Jul 2017.....	189
13.12. Are outcomes of non-interventional imposed PASS published? NEW Jul 2017 .....	190
13.13. What fee do I have to pay? NEW Jul 2017.....	190
13.14. Who should I contact if I have questions regarding my submission? Rev. Feb 2019 .....	191
13.15. Scientific advice for safety studies Rev. May 2017.....	192
13.16. When and how should study progress reports and interim results be submitted? Rev. Apr 2021 .....	197
<b>14. Post-authorisation efficacy study (PAES) .....</b>	<b>198</b>
14.1. What is a PAES imposed in accordance with the Commission Delegated Regulation? 198	
14.2. How and where the PAES imposed in accordance with the Commission Delegated Regulation will be reflected in the marketing authorisation? Rev. Jan 2021 .....	198
14.3. Following which procedure will my imposed PAES protocol be assessed?.....	199
14.4. When should I submit my imposed PAES protocol? Rev. Feb 2019 .....	199
14.5. In which timeframe will my imposed PAES protocol be evaluated (timetable)? .....	200
14.6. What are the possible outcomes of the evaluation of an imposed PAES protocol? ....	200
14.7. Do I have to submit interim results? .....	200



14.8. Do I have to submit the final results of my imposed PAES? Rev. Jun 2016 .....	201
14.9. Do I have to pay fees for the protocol and final study results submission? .....	201
14.10. How is a PAES enforced? .....	201
14.11. Will there be any publication on the outcome of my PAES protocol and final study results assessment? .....	202
14.12. Who should I contact if I have a question when preparing my application and during the procedure? Rev. Feb 2019 .....	202
<b>15. Post-Authorisation Measures (PAMs) .....</b>	<b>203</b>
15.1. What are PAMs? Rev. Apr 2015 .....	203
15.2. What is a specific obligation ['SOB']? Rev. Dec 2017 .....	204
15.3. What is an annex-II condition ['ANX']? Rev. Jun 2016 .....	205
15.4. What is an additional pharmacovigilance activity in the risk-management plan ['MEA']? Rev. Aug 2020.....	206
15.5. What is a legally binding measure ['LEG']? Rev. May 2020 .....	207
15.6. What is a recommendation ['REC']? Rev. Apr 2015 .....	208
15.7. Can the classification of my PAM change during its lifecycle? Rev. Apr 2015.....	208
15.8. When shall I submit my PAM? Rev. Aug 2018.....	208
15.9. Under which procedure should I submit my PAM? Rev. Jul 2021 .....	209
15.10. How shall I structure my PAM submission dossier? Rev. May 2020 .....	212
15.11. How and to whom shall I submit my PAM data? Rev. Feb 2019.....	213
15.12. How shall my submission of PAM be handled (timetable), and what could be the outcome of the evaluation? Rev. Jul 2021 .....	213
15.13. Do I have to pay fees for the PAM data submission? Rev. Apr 2015.....	214
15.14. How are PAMs enforced? Rev. Feb 2019 .....	214
15.15. Will there be any publication on the outcome of my PAM? Rev. Apr 2015.....	215
15.16. Who should I contact if I have a question when preparing my application? Rev. Apr 2019 .....	215
15.17. Who is my contact at the European Medicines Agency during post-authorisation procedures? Rev. Feb 2019 .....	215
<b>16. Risk Management Plan .....</b>	<b>216</b>
16.1. When should I submit a new/updated RMP? Rev. Dec 2017 .....	216
16.2. When is my RMP a stand-alone variation? Rev. Dec 2017 .....	217
16.3. What if my application does not include an updated RMP? Rev. Dec 2017 .....	217
16.4. Which variation classification will apply for my RMP updates? Rev. Aug 2020 .....	218
16.5. Which changes can be included in an RMP update without the need for an additional variation? Rev. Dec 2017 .....	220
16.6. Can I group my RMP updates? Rev. Dec 2017 .....	220
16.7. How should I handle parallel RMP submissions? Rev. Dec 2017 .....	221
16.8. How shall I present my RMP update? Rev. Oct 2019 .....	224
16.9. Can I submit a version of the RMP after the Opinion to reflect the last minute changes made during the CHMP? Rev. Dec 2017 .....	225
16.10. Is the PRAC Rapporteur involved in the assessment of RMP updates? .....	225
16.11. How long after the European Commission decision should Annex 1 of the RMP be submitted to EudraVigilance? Rev. Jan 2021 .....	226
16.12. How and to whom shall I submit my RMP application? Rev. May 2020 .....	226
16.13. What templates should I use for the RMP submission? NEW Dec 2017 .....	226

16.14. When and how will the RMP Summary be published on the EMA website? NEW Dec 2017 .....	227
16.15. How should I compile the list of safety concerns in the RMP for generic products when the originator products have an RMP? NEW Apr 2019 .....	227
<b>17. Periodic Safety Update Reports (PSURs) .....</b>	<b>229</b>
17.1. What is a Periodic Safety Update Report (PSUR)? Rev. Sep 2014.....	229
17.2. What is the scope of PSUR assessment under the EU single assessment? Rev. Mar 2017 .....	229
17.3. How shall I present my PSUR and in which format? Rev. May 2020.....	230
17.4. What is the List of European Union reference dates (EURD list) and frequency of submission of PSURs? Rev. Sep 2014 .....	232
17.5. When do changes to the EURD list become legally binding? Rev. Apr 2016 .....	233
17.6. How can I request to amend the list of EU reference dates? Rev. Dec 2019 .....	234
17.7. Do I have to submit a PSUR if the active substance/combination of active substances of my medicinal product is not in the EURD list? Rev. Mar 2014.....	234
17.8. Do I have to submit a PSUR if the combination of active substances of my product is not in the EURD list but one or more individual components are listed? Rev. Mar 2013 ....	235
17.9. Do I have to submit a PSUR if my medicinal product is not marketed? Rev. Mar 2013 .....	235
17.10. Do I have to submit a PSUR if the marketing authorization for my product has been granted on or after the data lock point (DLP) in the EURD list? NEW Mar 2017 .....	235
17.11. My company holds a Parallel Import Authorisation; do we have to submit PSUR for these product(s)? If a PSUR is submitted will it be assessed? NEW Mar 2017.....	235
17.12. Do I have to submit a PSUR for my medicinal product if it is a generic, a product containing a well-established substance, a homeopathic or herbal medicinal product? Rev. Mar 2017 .....	236
17.13. Do I have to submit a PSUR for my hybrid medicinal product? Rev. Sep 2014 .....	236
17.14. Do I have to submit a PSUR if my medicinal product is authorised in accordance with Article 126(a) of Directive 2001/83/EC? NEW Mar 2017 .....	237
17.15. Will the withdrawal/non-renewal/revocation of the marketing authorisation of my product impact on the ongoing EU single PSUR assessment? NEW Aug 2017 .....	237
17.16. Will I have to submit PSUR after withdrawal/non-renewal/revocation/suspension of the marketing authorisation of my product? Rev. Apr 2021 .....	237
17.17. Do PSURs need to contain case narratives and line listings? Rev. Sep 2014.....	238
17.18. How can I submit the proposed changes to the product information within the PSUR for the procedures which are part of an EU single assessment? Rev. Mar 2017 .....	238
17.19. Can I submit a RMP update together with my PSUR? Rev. Dec 2018 .....	239
17.20. Can I submit a clinical study report together with my PSUR? Rev. Aug 2020 .....	240
17.21. What are the timelines for the submission of PSURs? Rev. Mar 2017 .....	240
17.22. What happens if I missed the submission deadline? NEW Dec 2017.....	241
17.23. To whom should I submit my PSUR? Rev. Mar 2017 .....	241
17.24. How to identify the official contact person for the PSUR? NEW Mar 2017 .....	242
17.25. What fee do I have to pay? Rev. Apr 2021 .....	242
17.26. How will my PSUR submission be handled? Rev. Feb 2019 .....	243
17.27. How shall I submit the response to a request for supplementary information during a PSUSA procedure? Rev. Oct 2019 .....	247
17.28. How is the CHMP opinion/CMDh position structured and which annexes need to be translated? Rev. Apr 2021.....	247

17.29. To whom should I submit follow-up data requested after the conclusion of a PSUSA procedure? Rev. Feb 2019 .....	252
17.30. How can I know about the outcome of a PSUSA procedure? Rev. Dec 2019.....	252
17.31. How shall I implement the outcome of a PSUSA procedure? NEW Mar 2017 .....	253
17.32. Can PSURs still be submitted with renewal application? Rev. Mar 2013.....	254
17.33. Who should I contact if I have a question regarding the preparation of a PSUR submission and during the procedure? Rev. Dec 2019 .....	254
17.34. Who should I contact if I have a technical issue with the submission of the PSUR? Rev. Mar 2017.....	255
17.35. Who should I contact if I have an issue related to the EURD list? Rev. Jun 2016 ...	255
17.36. Who should I contact if I have an issue related to the payment of fee and QPPV advice notes? Rev. Apr 2021 .....	256
<b>18. Article 46 paediatric study submission .....</b>	<b>257</b>
18.1. What is the "Article 46 paediatric study submission"? .....	257
18.2. When shall I submit my article 46 paediatric study application? Rev. Dec 2014 .....	257
18.3. How shall I present my article 46 paediatric study application at submission? Rev. May 2020 .....	257
18.4. How and to whom shall I present my article 46 paediatric study application? Rev. Feb 2019 .....	258
18.5. How shall the evaluation of my article 46 paediatric study application be handled (timetable), and what could be the outcome of the evaluation? NEW Feb 2014 .....	258
18.6. Do I have to pay fees for the article 46 paediatric study submission? NEW Feb 2014 .....	259
18.7. Will there be any publication on the outcome of my article 46 paediatric study? Rev. Feb 2014 .....	259
<b>19. Transfer of Marketing Authorisation .....</b>	<b>260</b>
19.1. What is a Transfer of Marketing Authorisation? Rev. Jul 2021.....	260
19.2. How shall I present my application for the Transfer of Marketing Authorisation? Rev. Apr 2021 .....	260
19.3. How and to whom shall I submit my Transfer of Marketing Authorisation application? Rev. Feb 2019 .....	263
19.4. How shall my Transfer of Marketing Authorisation application be handled (timetable)? Rev. Jul 2021 .....	263
19.5. How to choose the implementation date? Rev. Jul 2021.....	264
19.6. What fee do I have to pay for my Transfer of Marketing Authorisation application? Rev. Apr 2021 .....	265
19.7. How to handle planned/ongoing variations procedures during the Transfer of Marketing Authorisation? Rev. Jul 2021 .....	265
19.8. How to handle remaining Post-authorisation measures and recommendations when transferring a Marketing Authorisation? Rev. Dec 2013 .....	266
19.9. Do I have to submit mock-ups and specimens? Rev. Dec 2015.....	266
19.10. Do I also have to transfer the Orphan designation when my medicinal product has been granted such a designation? Rev. Dec 2007.....	267
19.11. Can I include changes to manufacturing sites in my Transfer of Marketing Authorisation application? Rev. Jul 2021 .....	268
19.12. Can I change the Qualified Person for Pharmacovigilance and what information on the summary of the transferee's pharmacovigilance system should I submit as part of my Transfer of Marketing Authorisation application? Rev. May 2018 .....	268

19.13. Can I change the name of a medicinal product as part of a transfer application? Rev. Jul 2021 .....	269
19.14. Will there be any publication on the Transfer of Marketing Authorisation? .....	269
19.15. Who should I contact if I have a question when preparing my application or during the procedure? Rev. Jul 2021 .....	270
<b>20. Transparency.....</b>	<b>271</b>
20.1. Which EMA transparency measures apply for on-going marketing authorization application procedures? Rev. Aug 2016.....	271
20.2. Which transparency measure applies for the publication of assessment reports? Rev. Aug 2016.....	271
20.3. Which transparency measures apply with regard to the clinical data submitted by applicants/MAHs to support their regulatory applications? NEW May 2017.....	272
20.4. Which transparency measures apply with regard to EMA’s scientific committees? NEW Aug 2016.....	272
20.5. Which specialised databases are publicly available? Rev. Aug 2016.....	272
20.6. Does EMA provide monthly figures on centralised procedures for human medicines? Rev. Aug 2016.....	273
<b>21. Pharmacovigilance system summary.....</b>	<b>275</b>
21.1. Requirements regarding the summary of the pharmacovigilance system Rev. Jan 2016 .....	275
21.2. Requirements regarding the pharmacovigilance system and pharmacovigilance system master file NEW March 2013 .....	276
21.3. Subcontracting pharmacovigilance activities NEW March 2013.....	276
21.4. How to inform the authorities of a change in the summary of the pharmacovigilance system? Rev. Jan 2016.....	277
21.5. Is it mandatory to enter and maintain the location of the Pharmacovigilance System Master File in the XEVMPD? If so, how do we enter this information in the XEVMPD? NEW Jan 2016 .....	278
21.6. Is the information on the Deputy QPPV required as part of the summary of the pharmacovigilance system? Rev. Jan 2016.....	278
21.7. Is there a PSMF template? NEW Jan 2016.....	278
21.8. Pharmacovigilance System Master File location: can the server of the Pharmacovigilance System Master File be physically located and administered outside EU if it is validated and operational/accessible 24/7 for EU markets and EU QPPV? New Jan 2016	278
21.9. What information will be made public on the EU web-portal regarding pharmacovigilance contact details and PSMF locations? Will details of the QPPV be made public? New Jan 2016.....	278
<b>22. Article 61(3) Notifications .....</b>	<b>279</b>
22.1. What are Article 61(3) Notifications? Rev. Apr 2021.....	279
22.2. Is the Rapporteur involved in 61(3) Notifications?.....	280
22.3. When can I submit my 61(3) Notification? Rev. Feb 2021.....	280
22.4. How shall I present my 61(3) Notification? Rev. Apr 2021 .....	281
22.5. How and to whom shall I submit my 61(3) Notification? Rev. Feb 2019.....	282
22.6. How shall my 61(3) Notification be handled (timetable), and what could be the outcome? Rev. Feb 2021 .....	282
22.7. What fee do I have to pay for a 61(3) Notification?.....	283
22.8. Do I have to submit mock-ups and specimens? Rev. Aug 2014 .....	283

22.9. How and when will the updated Annexes become part of the Marketing Authorisation? Rev. Aug 2014.....	284
22.10. Will there be any publication on the outcome of my 61(3) Notification? Rev. Apr 2012 .....	285
22.11. Who is my contact at the European Medicines Agency during post-authorisation procedures? Rev. Feb 2019 .....	285
<b>23. Marketing status updates .....</b>	<b>286</b>
23.1. What is the meaning of “actual marketing” / “placing on the market”? Rev. Jul 2021 .....	286
23.2. What is the meaning of “cessation of placing on the market”? Rev. Jul 2021 .....	286
23.3. What is the aim of monitoring the marketing status of medicinal products? Rev. Jul 2021 .....	287
23.4. What information should be reported to the Agency on the marketing status of CAPs? Rev. Feb 2022 .....	287
23.5. When to report the marketing status overview of centrally-authorized products to the Agency? Rev. Jul 2021.....	288
23.6. How to report marketing status updates to the Agency for CAPs? Rev. Feb 2022 ....	289
23.7. When and how to notify marketing cessations for nationally authorised products to the Agency? NEW Jul 2021 .....	292
23.8. How will the Agency inform the Member States? Rev. Jul 2021.....	293
23.9. How should I request the withdrawal of my central marketing authorisation? NEW Jul 2021 .....	294
23.10. When and how to report to the Agency actions taken in 3 <sup>rd</sup> countries? NEW Feb 2022 .....	295
23.11. Which information does the Agency publish about the marketing status of EU medicinal products? Rev. Feb 2022 .....	295
23.12. Is there an obligation to market a medicine which is authorised for a paediatric indication, following completion of an agreed paediatric investigation plan, and the product has already been marketed with other indications? NEW Jul 2021 .....	296
<b>24. Sunset clause monitoring .....</b>	<b>297</b>
24.1. What is the sunset clause? Rev. Jul 2021.....	297
24.2. Does the sunset clause apply to existing medicinal products? Rev. Jul 2021 .....	297
24.3. What are the requirements to maintain a marketing authorisation for a centrally authorised medicinal product? Rev. Jul 2021 .....	298
24.4. How the sunset clause is monitored by the EMA? Rev. Jul 2021 .....	298
24.5. When is the sunset timer ON/OFF? Rev. Jul 2021 .....	298
24.6. In case of a protection period to be respected before placing the medicinal product on the market, when will the sunset clause period start? Rev. Jul 2021 .....	299
24.7. How to request an exemption to sunset clause provision for centrally-authorized products? Rev. Jul 2021.....	300

# 1. Type IA Variations

## 1.1. When shall I submit my Type IA/IA<sub>IN</sub> variation(s)? *Rev. Dec 2016*

Commission Regulation (EC) No 1234/2008 ('the Variations Regulation') and the "Commission guidelines on the details of the various categories of variations, on the operation of the procedures laid down in Chapters II, IIa, III and IV of Commission Regulation (EC) No 1234/2008 and on the documentation to be submitted pursuant to those procedures" ('the Classification Variations Guidelines') set-out a list of changes to be considered as Type IA variations. Such minor variations have only a minimal impact or no impact at all, on the quality, safety or efficacy of the medicinal product, and do not require prior approval before implementation ("Do and Tell" procedure). The Classification Guideline clarifies the conditions which must be met in order for a change to be considered a Type IA variation.

Such minor variations are classified in two subcategories, which impact on their submission:

### **Type IA variations requiring immediate notification ('IA<sub>IN</sub>')**

The Classification Guideline specifies which Type IA variations must be notified (submitted) **immediately** to the National Competent Authorities/European Medicines Agency ('the Agency') following implementation, in order to ensure the continuous supervision of the medicinal product.

### **Type IA variations NOT requiring immediate notification ('IA')**

Variations which do not require immediate notification may be submitted by the marketing authorisation holder (MAH) **within 12 months** after implementation or may be submitted earlier should this facilitate dossier life-cycle maintenance or when necessary e.g. to ensure that the latest product information is reflected in Certificates of Pharmaceutical Products.

The 12 months deadline to notify minor variations of Type IA allows for an 'annual reporting' for these variations, where a MAH submits several minor variations of Type IA which have been implemented during the previous twelve months.

Most of these Type IA variations do not impact on the product information. However, in case of an upcoming submission of a variation, extension or other regulatory procedure which will affect the product information, the MAH should also include any Type IA change(s) affecting the product information, in order to keep the product information up-to-date and to facilitate document management.

There are no recommended submission dates for Type IA. However, MAHs are encouraged to avoid submitting Type IA notifications shortly before or during the Agency holiday periods (e.g. end July and Christmas).

### **Meaning of "implementation" for Type IA variations**

For quality changes, implementation is when the Company makes the change in its own Quality System.

This interpretation allows companies to manufacture conformance batches and generate any needed stability studies to support a Type IA<sub>IN</sub> variation before making an immediate notification<sup>1</sup> because the change will not be made in their own Quality System until these data are available.

For product information, it is when the Company internally approves the revised product information. The revised product information will then be used in the next packaging run.

## **1.2. Can I group the submission of Type IA/IA<sub>IN</sub> variations? Can they be grouped with other types of variations? Rev. Sep 2014**

Article 7(2)(a) of the Variations Regulation sets out the possibility for a MAH to group several Type IA/IA<sub>IN</sub> variations under a single notification to the same relevant authority, or to group them with other types of variations.

Possible grouping of Type IA/IA<sub>IN</sub> changes only:

- Several Type IA or IAIN affecting one medicinal product.
- This means for instance that a Type IA variation, which is normally not subject to immediate notification, can be included in the submission of a Type IAIN variation.
- One Type IA or IAIN affecting several medicinal products from the same MAH.

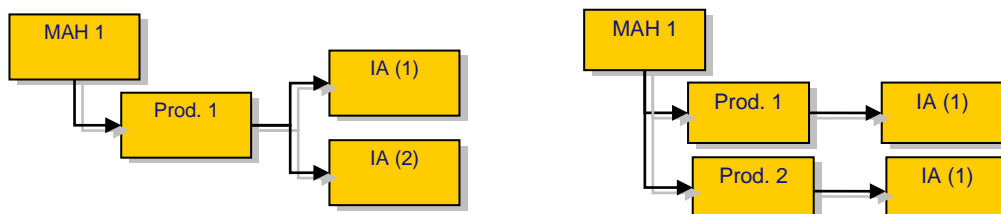

- Several Type IA and/or IAIN affecting several medicinal products from the same MAH provided that those variations are the same for all medicinal products and are submitted to the same relevant authority.

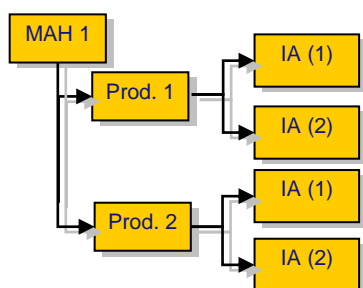

<sup>1</sup> For example the type IAIN for addition, deletion or replacement of components in the flavouring or colouring system requires stability data on at least two pilot scale or industrial scale batches.

Possible grouping of Type IA/IA<sub>IN</sub> with other types of variations:

- Type IA/IA<sub>IN</sub> can also be grouped with other variations (e.g. Type IB, Type II, Extension, as listed in Annex III of Commission Regulation 1234/2008. Groupings not included in the aforesaid Annex should be discussed and agreed with the Agency prior to submission.
- Such grouped submissions will follow the review procedure of the highest variation in the group. Please also refer to “What type of variations can be grouped?”.

It must be noted however, that when submitting Type IA/ IA<sub>IN</sub> variations as part of a group, the legal deadlines for submission of each variation should be respected i.e. a Type IA<sub>IN</sub> should always be submitted immediately, whether or not it is grouped with other variations, and any Type IA variation should always be submitted within 12 months following its implementation.

### **1.3. Is the (Co-) Rapporteur involved in the review of Type IA/IA<sub>IN</sub> variations? Rev. Aug 2014**

The Agency will review the notification within 30 days following receipt, without involvement of the Rapporteur or Co-Rapporteur.

However, a copy of the complete Type IA/ IA<sub>IN</sub> notification must be submitted to the Rapporteur and other Committee members at the time of submission (for information) to maintain the life cycle of the eCTD dossier (See also “How shall I present and submit my Type IA/ IA<sub>IN</sub> Variation”).

The same principle applies whether a single or a group of Type IA/ IA<sub>IN</sub> variations is being submitted.

However, if the Type IA/ IA<sub>IN</sub> Variations are grouped with other variations (Type IB, Type II, Extension), the grouped submission will follow the review procedure and timelines of the highest variation in the group and the Rapporteur will provide an assessment report for the group. Although the Rapporteur is not expected to assess the Type IA/IA<sub>IN</sub> variations in the group the Rapporteur will confirm in the assessment report whether non-acceptance of (part of) the change(s) in the group leads to non-acceptance of the Type IA/ IA<sub>IN</sub> changes in the group.

### **1.4. How shall I present and submit my Type IA/ IA<sub>IN</sub> Variation(s)? Rev. Mar 2022**

A type IA/ IA<sub>IN</sub> variation notification should contain the elements listed in Annex IV of the Variations Regulation and should be presented in accordance with the appropriate headings and numbering of the EU-CTD format. The Commission “Variations Guidelines” further specifies which elements should be included in a Type IA/ IA<sub>IN</sub> variation notification.

In order to help MAHs ensuring that their type IA/IA<sub>IN</sub> variations are complete and correct before submitting them to the Agency, it is strongly recommended to use the pre-notification checklist before submission of any type IA or type IA<sub>IN</sub> variation. Also, in order to facilitate the completion of the application form, MAHs are advised to consult the EMA/CMDh Explanatory Notes on Variation Application Form and the EMA Practical Guidance on the Application Form for Centralised type IA and IB variations.



Type IA variations are intended to provide for a simple, rapid and efficient procedure for minor changes. The MAH should be aware that the submission of redundant information or a confusing dossier presentation will not facilitate such procedures. Similarly, deficient and missing documentation can lead to rejection of the variation. However, in **exceptional cases** the Agency may issue a single request for supplementary information, for which a response should be provided within 4 working days in the mandatory eCTD format for electronic submissions. Failure to provide the requested information, or submission of incomplete and/or unsatisfactory responses within 4 working days may lead to an unfavourable outcome.

The following elements should be included in a Type IA/ IA<sub>IN</sub> variation notification, as specified in the Variations Guidelines:

- **Cover letter** (for groupings, include a short overview of the nature of the changes).
- In order to facilitate the registration of the submission, marketing authorisation holders are required to fill in all the submission attributes through the eSubmission delivery file UI.
- **Procedure number** – The procedure number will be assigned by the EMA only upon receipt of an eCTD application. For further details please refer to EMA pre-submission guidance “How is an EMA application/procedure number attributed?”
- The completed electronic **EU variation application form** (eAF), including the details of the marketing authorisation(s) concerned, as well as a description of all variations submitted together with their date of implementation. As of 1 July 2015, the use of the Electronic Application Form is mandatory for all centralised procedures. Information on the electronic Application Form for variations can be found in the eSubmissions eAF webpage. Where a variation leads to or is the consequence of other variations, a description of the relation between these variations should be provided in the appropriate section of the application form.
- MAH should pay particular attention when preparing the eAF for IG submissions (grouping of Type IA/IA<sub>IN</sub> variations) and ensure that the change(s) applied for are not repeated as many times as the products included as this will incur unnecessary fees being invoiced. It is understood that the same change(s) will apply to all products listed in the application.
- MAHs are reminded that the variation application form should be signed by the official contact person as specified in section 2.4.3 of Part IA/Module 1. Should the official contact person not be available, an official letter of authorisation confirming the delegation of signature to a different person should be enclosed. For a grouping affecting several medicinal products, MAHs are reminded to confirm in the application form under “Declaration of the applicant” that the MAs concerned belong to the same MAH and that the main signatory confirms authorisation to sign on behalf of the designated contacts.
- **Reference to the variation code** as laid down in the Annex to the Variations Guidelines, indicating that all conditions and documentation requirements are met, or reference to the published Article 5 Recommendation, if applicable, used for the relevant application. Applicable conditions and documentation should be clearly ticked on the extract provided or marked as n/a. if that is the case. If a condition and or documentation is n/a. a justification for its absence should be provided.
- **Relevant documentation** in support of the proposed variation, including all documentation as specified in the Annex.

- Please be reminded that in accordance with Union data protection requirements, no personal data should be included in the annotated product information annexes. This applies to the English version as well as to all the other languages translation versions. Please submit annotated product information annexes in an anonymised format (i.e. names of the reviewers removed from the track-changes). If you do not wish to do so, please ensure that the individuals whose data is included consented to its sharing with EMA and its further sharing by EMA with third parties such as other marketing authorisation applicants, marketing authorisation holders and National Competent Authorities, as relevant. EMA expressly disclaims any liability or accountability for the presence of unnecessary personal data in the annotated product information annexes submitted by the marketing authorisation holder.
- If applicable, the revised **summary of product characteristics** (SmPC or Annex I), annex II, labelling (Annex IIIA) and/or package leaflet (Annex IIIB) as a full set of annexes. If the change applied for affects Annex A, this should be provided as a separate set of one document per EU language. (See also question on 'When do I have to submit revised product information? In all languages?') Additional information on how to comply with this in a required technical format can be found in the Harmonised eCTD Guidance.
- Where the overall design and readability of the outer and immediate packaging and/or package leaflet is affected, the need for the provision of mock-ups or specimens should be discussed with the Agency Labeling Office on a case-by-case basis.

It should be noted that the responsibility for the quality of the submitted documentation lies with the MAH and is crucial to the overall process. The MAH is responsible for ensuring that the Type IA variation complies fully with the conditions and documentation requirements as specified in the Variations guidelines.

## Grouped Type IA/ IA<sub>IN</sub> variations

- For grouped Type IA/ IA<sub>IN</sub> variations concerning one marketing authorisation, all Type IA variations must be declared in the variation application form. The supportive documentation for all variations concerned should be submitted as one integrated package (i.e. there is no need to submit a separate documentation package for each variation). However, the present-proposed section of the application form should clearly identify the relevant CTD sections in support of each variation.
- For a (group of) Type IA/ IA<sub>IN</sub> variation(s) concerning several marketing authorisations, one eCTD sequence per medicinal product should be submitted. This will include a common cover letter and common application form referring to all medicinal products and variations concerned. The Agency will allocate a 'high-level' cross-products procedure number, which will be used for the handling of procedures which affect more than one medicinal product. A new procedure code (abbreviation) is used for groups of Type IA/ IA<sub>IN</sub> variations i.e. "IG". As the 'high-level' number cannot be allocated to one single product, the procedure number will therefore contain "xxxx" as a placeholder for the product number.

Example: EMEA/H/C/xxxx/IG/002

A 'high-level' procedure number should be obtained from the Agency shortly before submission. To submit your request, raise a ticket via EMA Service Desk, using the Question option. The Type of question to be selected is "Request for high-level procedure or ASMF number" followed by sub-option "IG Procedure Number (Type IA grouping)" and attaching a draft cover letter.

If you do not have an EMA Account, you may create one via the EMA Account Management portal.

Please note that requesting this 'high level' procedure number in advance is mandatory for submissions sent via the eSubmission Gateway or Web Client since this number must be included in the eSubmission Gateway XML delivery file User interface.

- In addition, for each medicinal product the relevant supportive documentation and revised product information (if applicable) should be provided, in order to allow the Agency to update the dossier of each marketing authorisation with the relevant updated/new information. Cross-references to any documentation submitted for another medicinal product can therefore not be accepted. For further details, please refer to "How shall I present a grouped variations application?" and to the Harmonised technical eCTD Guidance.

For procedural matters related to a type IA/ IA<sub>IN</sub> Variation for a specific product and in order to avoid rejection, please contact the EMA Service Desk, using the Question option. The Type of question to be selected is "Post-authorisation queries" followed by sub-option "Variation IA".

For more detailed queries on technical matters please contact the EMA Service Desk.

If you do not have an EMA Account, you may create one via the EMA Account Management portal.

## **Submission of Type IA/ IA<sub>IN</sub> Variation Notifications**

Information is available on 'Submitting a post-authorisation application'.

### **References**

- Regulation (EC) No 726/2004
- Commission Regulation (EC) No 1234/2008
- Commission Regulation (EU) No 712/2012 amending Regulation (EC) No 1234/2008 concerning the examination of variations to the terms of marketing authorisations for medicinal products for human use and veterinary medicinal products
- Guidelines on the details of the various categories of variations, on the operation of the procedures laid down in Chapters II, IIa, III and IV of Commission Regulation (EC) No 1234/2008 of 24 November 2008 concerning the examination of variations to the terms of marketing authorisations for medicinal products for human use and veterinary medicinal products and on the documentation to be submitted pursuant to those procedures
- Electronic Variation application form
- Variation application form, The Rules governing Medicinal Products in the European Union, Notice to Applicants, Volume 2C
- EMA/CMDh Explanatory Notes on Variation Application Form (CMDh/EMA/133/2010)
- EMA Practical Guidance on the Application Form for Centralised Type IA and IB Variations (EMA/233564/2014)
- Pre-notification checklist for Type IA variations
- Article 5 Recommendation

### **1.5. How shall my Type IA/IA<sub>IN</sub> variation be handled (timetable)? Rev. Oct 2012**

The Agency will review the (grouped) Type IA/ IA<sub>IN</sub> variation(s) within 30 calendar days following receipt. The Agency will check the correctness of the application form, the presence of the required documentation and compliance with the required conditions, in accordance with the Classification guideline.

Receipt of Type IA/ IA <sub>IN</sub> variation notification	Day 0
Start of Agency check	Day 1
Favourable/Unfavourable review outcome	by Day 30

By day 30, the Agency will inform by Eudralink the MAH about the outcome of the review.

Where the outcome of the procedure is favourable and the Commission Decision granting the Marketing Authorisation requires amendments, the Agency will inform the Commission accordingly.

Where one or several Type IA/ IA<sub>IN</sub> variations are submitted as part of one notification, the Agency will clearly inform the MAH about which variation(s) have been accepted or rejected following its review.

Type IA/ IA<sub>IN</sub> changes can be implemented prior to submission of the notification. However, in case of unfavourable outcome, the Variations Regulation requires the MAH to immediately cease applying the rejected variation(s). Please refer to "What should I do in case of an unfavourable review outcome for my type IA/ IA<sub>IN</sub> variation?" for further details.

It is still possible for MAHs to submit Type IA notifications prior to its implementation, particularly when the proposed changes are related to other notifications/variations requiring prior approval.

### **1.6. Can my Type IA/ IA<sub>IN</sub> be part of worksharing? Rev. Feb 2021**

In accordance with the provisions of Article 20 of the Variations Regulation, the worksharing procedure does not apply to Type IA/ IA<sub>IN</sub> variations.

However, the submission of one or several Type IA/ IA<sub>IN</sub> variations affecting more than one marketing authorisation of the same MAH, in one notification to the same relevant authority (similar to worksharing) is possible under Article 7(2) of the Regulation – see also "Can I group the submission of Type IA/ IA<sub>IN</sub> variations? Can they be grouped with other types of variations?"

This type of grouping is referred to as IG by the Agency.

A 'high-level' procedure number is assigned for all IG procedures submitted to the Agency. This number should be systematically obtained from the Agency shortly before submission by sending your request via EMA Service Desk. For further information see also Grouping of variations: questions and answers 'What procedure number will be given to grouped variation applications?'

If you do not have an EMA Account, you may create one via the EMA Account Management portal.

In addition, it is also possible to group a Type IA/ IA<sub>IN</sub> variation(s) with a Type IB or Type II variation, which is submitted for a worksharing procedure. In such case, the Rapporteur will be asked to confirm whether the non-acceptance of (part of) the change(s) leads to non-acceptance of Type IA/IA<sub>IN</sub> in the group. In this case, the 'high level' cross-products procedure number for the worksharing should be

obtained in like manner as for IG procedures. For further information see also Worksharing: questions and answers 'What procedure number will be given to variation applications under worksharing?'

### **1.7. What should I do in case of an unfavourable outcome for my Type IA/ IA<sub>IN</sub> variation(s)? Rev. July 2013**

A Type IA/ IA<sub>IN</sub> variation will be rejected when:

- The classification of the proposed change(s) is incorrect
- not all of the conditions for the Type IA/ IA<sub>IN</sub> variation are met
- the submitted documentation as required by the Variations Guideline is deficient or inaccurate, including provision of the product information Annexes and Annex A, if affected by the change(s) applied for.

In such case, the MAH shall immediately cease to apply the rejected changes.

In the case of a negative outcome of a Type IA application because the conditions for Type IA variation(s) are not met and consequently a resubmission (as a Type IB, Type II variation or Extension) is needed or because documentation is deficient, it is the MAH responsibility to judge whether the rejected Type IA variation has an impact on the quality, safety or efficacy of the medicinal product. If this is the case, the MAH has to take appropriate action.

The Agency may ask the MAH to complete a suspected quality defect notification form and provide a Risk Assessment report on the impact of the product on the market via e-mail to [qdefect@ema.europa.eu](mailto:qdefect@ema.europa.eu) within 7 calendar days from the date of the rejection letter. Such requests are expected to be very exceptional. The MAH has to follow the instructions under Notifying Quality Defects or Product Recalls.

### **1.8. What fee do I have to pay for a Type IA/ IA<sub>IN</sub> variation? Rev. Apr 2021**

For information on the fee applicable for Type IA/ IA<sub>IN</sub> variations, please refer to the explanatory note on fees payable to the European Medicines Agency. Such fee covers all authorised strengths, pharmaceutical forms and presentations of a given medicinal product.

For variations introducing additional presentation(s)/pack-size(s), each additional presentation/pack-size attracts separate fees ('x' additional presentations = 'x' separate fees). Each presentation/pack-size should therefore be declared as a separate variation on the variation application form under the section 'Variations included in this application'.

Grouped Type IA/ IA<sub>IN</sub> variations, whether consequential or not, will each attract a separate Type IA fee.

The fee will become due on the date of receipt of Type IA/ IA<sub>IN</sub> variation notification and fees will be payable within 45 calendar days of the date of the said notification. After approximately 15 days an invoice will be sent to the applicants billing address held on the Agency's file.

The invoice will contain details of the product and type of procedure involved, the fee amount, the financial information and customer purchase order number associated with the procedures invoiced (if

provided in the eSubmission delivery file). The Agency does not accept stand-alone notifications of purchase order numbers that are not associated with a dossier.

The Agency will charge the fee for type IA variations or grouped type IA variations at the start of the procedure, irrespective of its outcome (positive, negative or partial/full withdrawal).

In accordance with the CHMP Procedural Announcements published on 15 March 2012, MAHs are reminded that fees for type IA variations become due at the start of the 30-day procedure. Fees are charged based on what has been declared in the application form regardless of the outcome (i.e. fees apply equally for accepted and rejected scopes).

The above means that, once submitted to the Agency, modifications such as addition or deletion of type IA variation scopes are not possible. The Agency cannot accept any revised application form to change the type or number of scopes applied for as part of any submission of Supplementary Information for Type IA variations.

Type IA variations which are grouped with other type of variations/extensions or which are part of worksharing procedure will continue to be charged on conclusion of the validation of the application.

Guidance on how to pay an invoice can be found on our website.

#### **References**

- Explanatory note on fees payable to the European Medicines Agency

### ***1.9. Do I have to submit mock-ups and specimens? Rev. July 2013***

For information concerning submission of mock-ups and specimens in the framework of post-authorisation procedures, please refer to the document 'Checking process of mock-ups and specimens of outer/immediate labelling and package leaflet of human medicinal products in the centralised procedure, 3.4 Other post-authorisation procedures.

#### **References**

- Checking Process of Mock-Ups and Specimens of outer/immediate labelling and package leaflets of human medicinal products in the Centralised Procedure (EMA/305821/2006)

### ***1.10. What changes will trigger new EU number(s) (additional presentation(s))? Rev. Feb 2021***

Any changes in the number of units of medicinal product or medical device being an integral part of the medicinal product (e.g. prefilled syringes) will trigger a different EU number.

Differentiation should be made between the addition of a presentation where the two presentations will co-exist on the market on a long-term basis versus a replacement of a presentation where the new presentation will replace the previous one (it is expected that for a certain period of time, the two presentations will co-exist on the market until the stock of the previous presentation runs out).

In principle, a **replacement** of one presentation by another presentation does not trigger a new EU number, unless the number of units of medicinal product or medical device being an integral part of the medicinal product (e.g. prefilled syringes) is changed.

Examples of changes in presentations for replacement, not triggering a new EU number (this is not an exhaustive list):

- Replacement of the primary or secondary packaging,
- Changes in the number of medical devices not being integral part of the medicinal product,
- Change in composition (e.g. change in excipients),
- Change in units per blisters (without change to the total number of units per pack).

Examples of changes in presentations for replacement, triggering a new EU number (this is not an exhaustive list):

- 30 to 60 tablets,
- 2 prefilled syringes containing the medicinal product instead of one prefilled syringe.

In case of **addition**, as the presentations will co-exist on the market, two packs with different contents cannot be covered by the same EU number and will be considered as different presentations.

Changes in the number of any unit (not restricted to the medicinal product) or changes in the specifications of any unit (not restricted to the medicinal product) contained in the pack will trigger a new EU number.

Examples of changes that will trigger new EU numbers (this is not an exhaustive list):

- Introduction of an alternative injection kit with a different number of syringes or swabs,
- Introduction of an alternative syringe of different volume or an alternative syringe with a needle guard,
- Introduction of an alternative immediate (primary) packaging made from a different material,
- Introduction of an alternative shape/dimension of a pharmaceutical form (pre-rolled sealant matrix versus flat, change in size of patch).

If you have any questions on any upcoming submission, please contact us by raising a ticket via EMA Service Desk, using the Question option. The Type of question to be selected is "Post-authorisation queries", followed by the relevant sub-option "Variation IA" or "Variation IB".

If you do not have an EMA Account, you may create one via the EMA Account Management portal.

### **1.11. How to obtain new EU sub-numbers for Type IA<sub>IN</sub> variation concerning an additional presentation (e.g. new pack-size)? Rev. Feb 2021**

In the specific case of a Type IA<sub>IN</sub> Variation for an additional presentation, the new EU marketing authorisation sub-number should be requested from the Agency before implementation.

The request should be sent together with a checklist and a draft Annex A (in English only) through the EMA Service Desk, using the Question option. The Type of question to be selected is "Post-authorisation queries" followed by sub-option "New EU number". The request should be made at least 5 working days in advance of the intended submission of the variation. Once a number has been allocated, this number should subsequently be included in the Annex A and product information annexes submitted together with the Variation notification.

### **1.12. When do I have to submit revised product information? In all languages? Rev. Apr 2021**

In case the Type IA/ IA<sub>IN</sub> notification affects any of the annexes, i.e. annex A, SPC, annex II, labelling and/or package leaflet, the affected revised product information Annexes must be submitted as follows:

- All EU language versions: complete set of Annexes electronically only in Word format (highlighted) and in PDF (clean)

The 'complete set of Annexes' includes Annex A (if applicable), I, II, IIIA and IIIB i.e. all authorised presentations (if applicable), SmPC, labelling and PL texts for all strengths and pharmaceutical forms of the product concerned, as well as Annex II. The complete set of Annexes must be presented sequentially (i.e. Annex I, II, IIIA, IIIB) as one document for each official EU language. Page numbering should start with "1" (bottom, centre) on the title page of Annex I. If annex A is affected, the document should also be provided in all EU official languages as a separate set. The 'QRD Convention' published on the Agency website should be followed. When submitting the full set of Annexes in PDF format, this should be accompanied by the completed formatting checklist. A user guide on how to generate PDF versions of the product information and annexes is also available.

Please be reminded that in accordance with Union data protection requirements, no personal data should be included in the annotated product information annexes. This applies to the English version and as well as all the other languages translation versions. Please submit annotated product information annexes in an anonymised format (i.e. names of the reviewers removed from the track-changes). If you do not wish to do so, please ensure that the individuals whose data is included consented to its sharing with EMA and its further sharing by EMA with third parties such as other marketing authorisation applicants, marketing authorisation holders and National Competent Authorities, as relevant. EMA expressly disclaims any liability or accountability for the presence of unnecessary personal data in the annotated product information annexes submitted by the marketing authorisation holder.

The electronic copy of all languages should be provided as part of the variation application. Highlighted changes should be indicated via 'Tools – Track Changes'. Clean versions should have all changes 'accepted'.

Icelandic and Norwegian language versions must always be included.

The Annexes provided should **only** reflect the changes introduced by the Variation(s) concerned. However, in **exceptional cases** where MAHs take the opportunity to introduce minor linguistic or typographical corrections in the texts this should be clearly mentioned in the cover letter and in the scope section of the application form.

In addition, the section "present/proposed" in the application form should clearly list the minor linguistic or typographical corrections introduced for each language. Alternatively, such listing may be provided as a separate document attached to the application form. Any changes not listed, will not be considered as part of the variation application.



In such cases and in cases where any other on-going procedure(s) may affect the product information Annexes, the MAH is advised to contact the Agency in advance of submission or finalisation of the procedure(s) concerned.

When the Type IA/ IA<sub>IN</sub> Notification concerns several medicinal products, the relevant complete set of product information Annexes should be included in the eCTD sequence for each product concerned.

For Type IA/ IA<sub>IN</sub> **variations affecting Annex A** (e.g. introduction of a new presentation), translations of the revised Annex A in all EU languages should be provided as separate documents in PDF format and EN tracked Word, together with the variation application. Where the variation introduces (a) new EU sub-number(s), this/these should be included in the Annex A and in the product information texts as part of the variation application (see also "How to obtain new EU sub-numbers for a Type IA<sub>IN</sub> variation concerning an additional presentation (e.g. new pack-size)"?).

Similarly, in case of a deletion of a pharmaceutical form/strength/pack-size(s), the amended Annex A and product information Annexes should be provided as part of the Variation application.

### ***1.13. How and when will the updated product information Annexes become part of the Marketing Authorisation? Rev. Oct 2012***

For Type IA/ IA<sub>IN</sub> variations affecting the product information Annexes to the Commission Decision, the Commission Decision will be updated within one year.

By the end of this period, the Agency will send the complete set of Annexes, based on the latest (previously) approved Annexes and reflecting the Type IA/ IA<sub>IN</sub> change(s) agreed during the past year together with a line-listing of those Type IA/ IA<sub>IN</sub> notification(s). The Commission will subsequently issue a Commission Decision on the Type IA/ IA<sub>IN</sub> notification(s) concerned.

However, where an Opinion affecting the Annexes which is followed by an immediate Commission Decision, e.g. listed in the Article 23.1a(a), is transmitted to the Commission within this yearly period the changes of the Type IA/ IA<sub>IN</sub> notification(s) concerned will already be included in the Annexes to that Opinion and will consequently be reflected in the resulting Commission Decision. This Commission Decision will therefore replace the yearly updating of the MA for the Type IA/ IA<sub>IN</sub> notification(s) concerned.

At the occasion of the next Type IA/ IA<sub>IN</sub> variation affecting the Annexes, the procedure outlined above will be repeated based on the new 'Reference point' of the next Type IA/ IA<sub>IN</sub> concerned.

(See also diagram below, which illustrates the updating process.)

In addition, it is important that in case of an upcoming submission of a variation, extension or other regulatory procedure which will affect the product information, the MAH should also include as a grouping application any Type IA change(s) affecting the product information that have not been previously notified, in order to keep the product information up-to-date and to facilitate document management.

Where a Type IA/ IA<sub>IN</sub> notification concerns several marketing authorisations, the Commission will update the marketing authorisation with one Decision per marketing authorisation concerned.

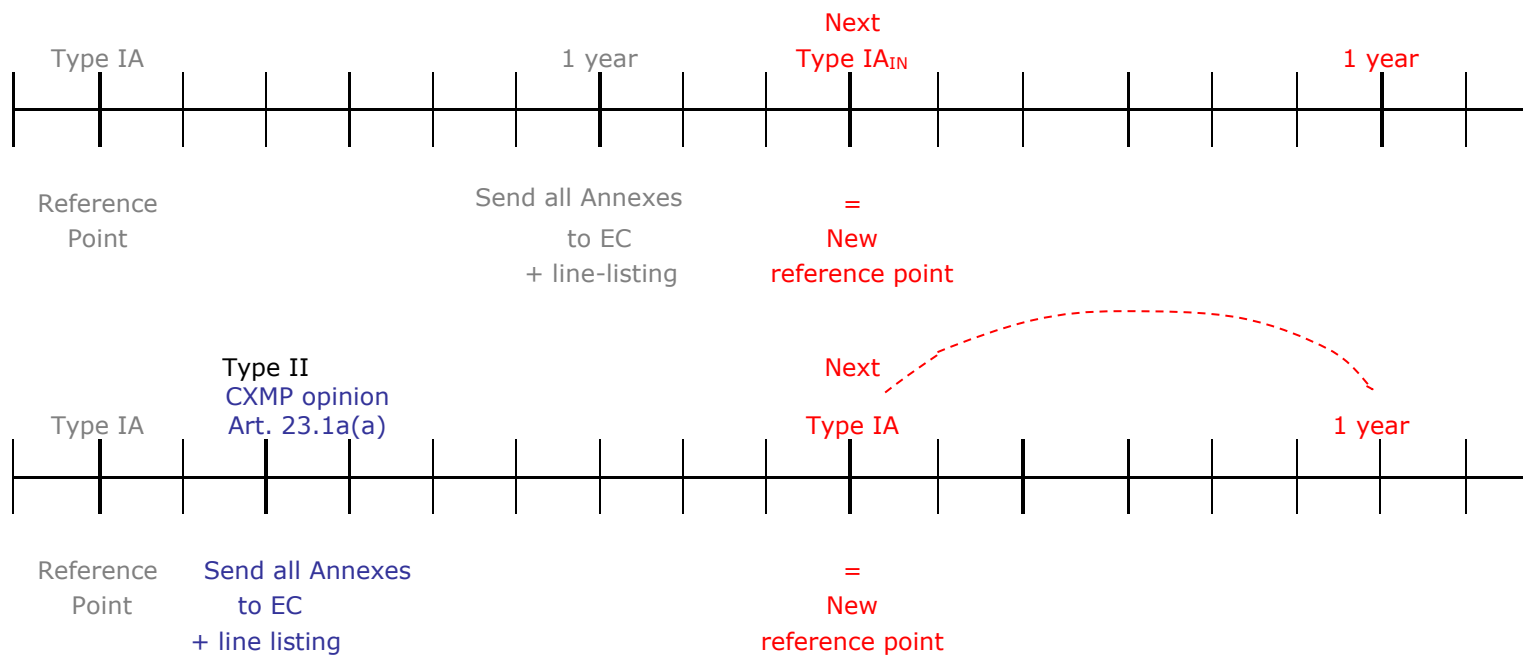

**1.14. What should be the date of revision of the text for Type IA Variations? *New Oct 2010***

Type IA/IA<sub>IN</sub> variations do not require prior approval before implementation (“Do and Tell” procedure), i.e. they can be implemented and notified to the Agency either immediately for Type IA variations requiring immediate notification (‘IA<sub>IN</sub>’) or within 12 months for Type IA variations not requiring immediate notification (‘IA’).

For Type IA variations affecting the product information, the date of revision of the text to be included in section 10 of the summary of product characteristics and in the corresponding section of the package leaflet at the time of printing should be the date of implementation of the change by the Marketing Authorisation Holder.

The meaning of “implementation” is explained in question and answer 1. When shall I submit my Type IA/IA<sub>IN</sub> variation(s)?

**1.15. Who should I contact if I have a question when preparing my application or during the procedure? *Rev. Feb 2021***

If you cannot find the answer to your question in the Q&A when preparing your application, please contact us by raising a ticket via EMA Service Desk using the Question option. The Type of question to be selected is “Post-authorisation queries”, followed by sub-option “Variation IA”.

The Agency aims to respond to your query within 10 working days. To help us deal with your enquiry, please provide as much information as possible including the name of the product in your correspondence.

You should submit your query once and it is important that you submit it using the applicable type of question and sub-option. If you are uncertain on a classification of a variation as type IA or type IB please use only one of the sub-option "Variation IA" or "Variation IB A&B scopes" or "Variation IB C scopes". Your query will be channelled internally to the relevant service(s) that will respond to you.

If you do not have an EMA Account, you may create one via the EMA Account Management portal.

Type IA variations will be handled by a dedicated team of Procedure Managers (PM). You will be able to contact this PM throughout the procedure.

## 2. Type IB variations

### 2.1. What changes are considered Type IB variations? *Rev. Oct 2013*

Commission Regulation (EC) No 1234/2008 ('the Variations Regulation') defines a minor variation of Type IB as a variation which is neither a Type IA variation nor a Type II variation nor an Extension. Such minor variations must be notified to the National Competent Authority/European Medicines Agency ('the Agency') by the Marketing Authorisation Holder (MAH) before implementation, but do not require a formal approval. Upon acknowledgement of receipt of a valid notification, the MAH must wait a period of 30 days to ensure that the notification is deemed acceptable by the National Competent Authority/the Agency before implementing the change ("Tell, Wait and Do" procedure).

The "Commission guidelines on the details of the various categories of variations, on the operation of the procedures laid down in Chapters II, IIa, III and IV of Commission Regulation (EC) No 1234/2008 and on the documentation to be submitted pursuant to those procedures" ('the Variations Guidelines'), contains examples of changes which are considered as Type IB variations. In addition, any change which is not an Extension and whose classification is not determined taking into account the Commission Guideline and the recommendations delivered pursuant to Article 5 of the Variations Regulation is considered a Type IB variation by default.

When one or more of the conditions established in the Classification Guideline for a Type IA variation are not met, the concerned change may be submitted as a Type IB variation unless the change is specifically classified as a major variation of Type II.

For changes which are submitted as default Type IB variations, the Agency will determine during validation whether the proposed classification as Type IB variation is appropriate before the start of the evaluation procedure (see also "How shall my Type IB variation be handled?")

#### References

- Regulation (EC) No 726/2004
- Commission Regulation (EC) No 1234/2008 (OJ L334 of 12 December 2008)
- Commission Regulation (EU) No 712/2012 amending Regulation (EC) No 1234/2008 concerning the examination of variations to the terms of marketing authorisations for medicinal products for human use and veterinary medicinal products
- Guidelines on the details of the various categories of variations, on the operation of the procedures laid down in Chapters II, IIa, III and IV of Commission Regulation (EC) No 1234/2008 of 24 November 2008 concerning the examination of variations to the terms of marketing authorisations for medicinal products for human use and veterinary medicinal products and on the documentation to be submitted pursuant to those procedures
- CMDh recommendation for classification of unforeseen variations according to Article 5 of Commission Regulation (EC) 1234/2008

### 2.2. Is the (Co-) Rapporteur involved in Type IB Variations? *Rev. Feb 2019*

Upon validation of the notification by the Agency, the Rapporteur will be involved in the evaluation of Type IB variations "How shall my Type IB variation be handled (timetable)?"

The Co-Rapporteur is not involved in the assessment of Type IB variations.

### **2.3. Can I group the submission of Type IB variations? Can they be grouped with other types of variations? Rev. Oct 2013**

MAHs may choose to group the submission of several Type IB variations for the same product into one notification. It is also possible for a MAH to group a Type IB variation with other variation(s) for the same product (e.g. Type IA, Type II, Extension), where applicable.

Allowed groupings are listed in Annex III of the Variations Regulation. Other groupings have to be agreed in advance with the Agency. Any proposal to group clinical and quality variations should be adequately justified.

Such grouped submissions will follow the review procedure of the highest variation in the group. Please also refer to "What type of variations can be grouped?".



Where the same minor Type IB variation(s) affect more than one marketing authorisations from the same holder, the MAH may choose to submit these variations as one application for 'worksharing'. Please also refer to "What is worksharing and what type of variations can be subject to worksharing?".

#### **References**

- Regulation (EC) No 726/2004
- Commission Regulation (EC) No 1234/2008 (OJ L334 of 12 December 2008)
- Commission Regulation (EU) No 712/2012 amending Regulation (EC) No 1234/2008 concerning the examination of variations to the terms of marketing authorisations for medicinal products for human use and veterinary medicinal products
- Guidelines on the details of the various categories of variations, on the operation of the procedures laid down in Chapters II, IIa, III and IV of Commission Regulation (EC) No 1234/2008 of 24 November 2008 concerning the examination of variations to the terms of marketing authorisations for medicinal products for human use and veterinary medicinal products and on the documentation to be submitted pursuant to those procedures

## 2.4. How shall I present and submit my Type IB Variation? Rev. Mar 2022

A Type IB variation notification should contain the elements listed in Annex IV of the Variations Regulation and should be presented in accordance with the appropriate headings and numbering of the EU-CTD format.

In order to help MAHs ensuring that their type IB variations are complete and correct before submitting them to the Agency, it is strongly recommended to use the pre-notification checklist before submission of any type IB variation.

In order to facilitate the completion of a correct application form before submission to the Agency, MAHs are advised to consult the EMA/CMDh Explanatory Notes on the Variation Application Form and the EMA Practical Guidance on the Application Form for Centralised type IA and IB variations.

The Commission 'Variations Guidelines' further specifies which elements should be included in a Type IB variation notification:

- Cover letter (for groupings, include a short overview of the nature of the changes and indicate whether it is submitted under Article 7.2(b), i.e. it falls within one of the cases listed in Annex III of the variations regulation or it is submitted under Article 7.2(c), i.e. the grouping has been agreed with the Agency). The MAH should indicate when the exact same change is submitted for different products in separate IBs.
- In order to facilitate the registration of the submission, applicants are required to fill in all the submission attributes through the eSubmission delivery file UI.
- **Procedure number** – The procedure number will be assigned by the EMA only upon receipt of an eCTD application. For further details please refer to EMA pre-submission guidance "How is an EMA application/procedure number attributed?"
- The completed electronic EU variation application form (eAF), including the details of the marketing authorisation concerned. Where a variation is considered a Type IB by default, a detailed justification for its submission as a Type IB notification must be included. MAHs are reminded that the variation application form should be signed by the official contact person as specified in section 2.4.3 of Part IA/Module 1. Should the official contact person not be available, an official letter of authorisation confirming the delegation of signature to a different person should be enclosed.
- Reference to the variation code as laid down in the Annex to the Variations Guidelines, or reference to the published Article 5 Recommendation, if applicable, used for the relevant application. Applicable documentation should be clearly ticked on the extract provided or marked as n/a if the case. If documentation is n/a, a justification for its absence should be provided. The extract(s) can be submitted as a separate annex in module 1.2.
- Relevant documentation in support of the proposed variation including all documentation as specified in the Annex of the Commission Variations Guidelines.
- For variations submitted to implement changes requested by the Agency or for generic/hybrid/biosimilar medicinal products, where no new additional data are submitted by the MAH, a copy of the request should be annexed to the cover letter.
- For procedures affecting the product information (with or without linguistic review), the revised summary of product characteristics (SmPC or Annex I), annex II, labelling (Annex IIIA) and package leaflet (Annex IIIB) should be provided as a full set of annexes in all EEA languages (in

word highlighted electronically and in PDF clean version). (See specific requirements for procedures with and without linguistic review in section “When do I need a linguistic review for changes in the product information?” and “How should I submit revised product information? In all languages?”).

- Please be reminded that in accordance with Union data protection requirements, no personal data should be included in the annotated product information annexes. This applies to the English version as well as all the other translation versions. Please submit annotated product information annexes in an anonymised format (i.e. names of the reviewers removed from the track-changes). If you do not wish to do so, please ensure that the individuals whose data is included consented to its sharing with EMA and its further sharing by EMA with third parties such as other marketing authorisation applicants, marketing authorisation holders and National Competent Authorities, as relevant. EMA expressly disclaims any liability or accountability for the presence of unnecessary personal data in the annotated product information annexes submitted by the marketing authorisation holder.
- If the change also affects Annex A (irrespective of the need for a linguistic review), the Annex A should be provided as a separate set of documents (in word highlighted electronically and in PDF clean version) in each EU language (See section “How should I submit revised product information? In all languages?”).
- Where the overall design and readability of the outer and immediate packaging and/or package leaflet is affected, the need for the provision of mock-ups or specimens should be discussed with the Agency Labelling Office on a case-by-case basis.

## **Grouped variations**

For grouped variations concerning one marketing authorisation, all variations must be declared in the variation application form. The documentation requirements for each type of variation in the group must be adhered to. However, the supportive documentation for all variations concerned should be submitted as one integrated package (i.e. there is no need to submit a separate documentation package for each variation). The present-proposed section of the application form should clearly identify the relevant eCTD sections in support of each variation. For grouped variations please refer to “Can I group the submission of Type IB variations? Can they be grouped with other types of variations?”. For grouped variations concerning more than one marketing authorisation please refer to “What is worksharing and what types of variations can be subject to worksharing?”.

It should be noted that the responsibility for the quality of the submitted documentation lies with the MAH and is crucial to the overall process. The MAH is responsible for ensuring that the Type IB variation complies fully with the data and documentation requirements as specified in the Variations Guidelines. The MAH should pay particular attention to grouping of variations, for which each change should be clearly identified as well as the related supportive documentation. A confusing dossier presentation may delay the procedure.

For queries on technical matters please contact the EMA Service Desk. For procedural matters related to a Type IB notification for a specific product and in order to avoid rejection, please see Question 12. “Who should I contact if I have a question when preparing my application?”).

## **Submission of Type IB Notifications**

Information is available on ‘Submitting a post-authorisation application’.

## References

- Regulation (EC) No 726/2004
- Commission Regulation (EC) No 1234/2008
- Commission Regulation (EU) No 712/2012 amending Regulation (EC) No 1234/2008 concerning the examination of variations to the terms of marketing authorisations for medicinal products for human use and veterinary medicinal products
- Guidelines on the details of the various categories of variations, on the operation of the procedures laid down in Chapters II, IIa, III and IV of Commission Regulation (EC) No 1234/2008 of 24 November 2008 concerning the examination of variations to the terms of marketing authorisations for medicinal products for human use and veterinary medicinal products and on the documentation to be submitted pursuant to those procedures
- Electronic Variation application form, The Rules governing Medicinal Products in the European Union, Notice to Applicants, Volume 2C
- EMA/CMDh Explanatory Notes on Variation Application Form (CMDh/EMA/133/2010)
- EMA Practical Guidance on the Application Form for Centralised Type I variations (EMA/233564/2014)
- Article 5 Recommendation

### **2.5. When shall I submit my Type IB Variation? Rev. Apr 2016**

There are no recommended submission dates for type IB variations with **no** changes to the product information or IB variations with changes to the product information **which do not require** linguistic review.

The Agency has published recommended submission dates for Type IB variations requiring linguistic review.

The timetable for IB variations with linguistic review does not apply to:

- type IB variations included in a worksharing (WS) submission (as they follow WS timetable)
- type IB variations submitted as part of a group including Type II variations and/or extensions (as they follow type II or extensions timetable).

(See specific requirements for procedures with and without linguistic review in section "When do I need a linguistic review for changes in the product information?" and "How should I submit revised product information? In all languages?")

Where the CHMP requests a variation for generic/hybrid/biosimilar medicinal products following assessment of the same change for the reference product, MAHs must submit the corresponding variation application at the latest within 2 months following the adoption of the relevant assessment conclusion.

Variation applications reflecting the outcome of an Urgent Safety Restriction (USR) shall be submitted immediately and in any case no later than 15 days after the initiation of the USR to the Agency. This applies to USRs initiated by the MAH or imposed by the European Commission.



## References

- Regulation (EC) No 726/2004
- Commission Regulation (EC) No 1234/2008 (OJ L334 of 12 December 2008)
- Commission Regulation (EU) No 712/2012 amending Regulation (EC) No 1234/2008 concerning the examination of variations to the terms of marketing authorisations for medicinal products for human use and veterinary medicinal products

## **2.6. When do I need a linguistic review for changes in the product information? *NEW Apr 2016***

The linguistic review for IB variations will take place in parallel to the 30-day scientific assessment.

A linguistic review will, in general, be required for type IB variations with changes affecting the product information where the changes in wording have not previously undergone linguistic review.

Some examples of Type IB variations where a linguistic review will be performed include safety and efficacy Type IB variations affecting the product information, where the wording has not been provided by the Agency in all languages prior to the start of the procedure.

Some examples of Type IB variations where, in principle, a linguistic review will not be performed are:

- Quality variations:
  - change in the shelf life of the finished product
  - change to the storage conditions of the finished product
  - change in the name and/or address of the marketing authorisation holder and batch release site
  - change in the name of the medicinal product
  - addition of new presentations or changes to the existing ones
- C.I.2.a) Change in the Summary of Product Characteristics, Labelling or Package Leaflet of a generic/hybrid/biosimilar medicinal products following assessment of the same change for the reference product
- Deletion of information from the product information
- Change to a new version of QRD template (a linguistic review could be exceptionally deemed necessary if the change encompasses several QRD versions)
- Implementation of safety signals following a recommendation from the PRAC where the translations have been provided to the applicant.

## References

- Regulation (EC) No 726/2004
- Commission Regulation (EC) No 1234/2008 (OJ L334 of 12 December 2008)

- Commission Regulation (EU) No 712/2012 amending Regulation (EC) No 1234/2008 concerning the examination of variations to the terms of marketing authorisations for medicinal products for human use and veterinary medicinal products.
- The Linguistic Review Process of Product Information in the Centralised Procedure – Human

## **2.7. How shall my Type IB variation be handled (timetable)? Rev. Apr 2016**

Upon receipt of a Type IB notification, the Agency will handle the notification as follows:

### **a) Handling of Type IB variations included ('foreseen') in the Classification Guideline or covered by an Article 5 Recommendation:**

#### **Submission and validation**

The Agency will check within 7 calendar days whether the variation is correct and complete ('validation') before the start of the evaluation procedure.

Day	Action
Day x	Receipt of Type IB variation
Day x+1	Start of Agency validation
Day x+7 (in case of missing or incorrect information, this period will be extended to accommodate a Validation Supplementary Information to the MAH)	Agency validation

Issues identified during validation will be notified to the MAH via e-mail. The MAH will be requested to provide responses to the issues raised within 5 working days. Delayed or insufficient responses will lead to complete or partial invalidation (in case of groupings) of the application as only one request for supplementary information will be issued during the validation phase.

The Agency will send to the MAH a confirmation of the positive outcome of the validation and the start date of the procedure.

#### **Evaluation**

Day	Action
Day 1	Start of evaluation
by Day 20	Internal circulation of Assessment Report*
by Day 30	(Non-)acceptance of the variation

\*Assessment Report will be sent to the applicant only at the end of the procedure not at Day 20 together with the IB notification.

Within 30 calendar days following the acknowledgement of receipt of a valid notification, the Agency will notify the MAH by Eudralink of the outcome of the procedure. The Eudralink message will contain "Notification of a Type IB variation to the terms of the Marketing Authorisation" and the Assessment

Report. If the Agency has not sent the holder its opinion on the notification within 30 calendar days, the notification shall be deemed acceptable.

### **Submission of amended notification (responses to Request for Supplementary Information (RSI))**

<b>Day</b>	<b>Action</b>
by Day 30	Non-acceptance of the variation (RSI)
by Day 60	Submission of an amended Notification (submission of responses to RSI by MAH)

In case of an unfavourable outcome the MAH may, within 30 calendar days, amend the notification to take due account of the grounds for the non-acceptance of the variation. If the MAH does not amend the notification as requested, the notification shall be rejected.

### **Evaluation (assessment of responses to RSI)**

<b>Day</b>	<b>Action</b>
Day 60	Receipt of an amended Notification
by Day 80	Internal circulation of Assessment Report
by Day 90	Final (Non-)acceptance of the variation

Within 30 calendar days of receipt of the amended notification, the Agency will inform the MAH of its final (non-)acceptance of the variation and whether the Commission Decision granting the Marketing Authorisation requires any amendments.

Where the outcome of the procedure is favourable and the Commission Decision granting the Marketing Authorisation requires amendments, the Agency will inform the Commission accordingly.

Where Type IB Variations affect the Annexes to the Marketing Authorisation, such changes can be implemented without awaiting the update of the Commission Decision and the agreed change(s) should be included in the Annexes of any subsequent Regulatory Procedure.

#### **b) Handling of Type IB variations claimed by the MAH to be IB variations by default**

The Agency will check within 7 calendar days whether the proposed change can be considered a minor variation of Type IB, and whether the notification is correct and complete ('validation') before the start of the evaluation procedure. In exceptional cases, the Agency may have to consult with the Rapporteur on the appropriate classification of the variation, which may lead to a slightly longer validation period (up to 10 working days).

When the Agency is of the opinion that the proposed variation may have a significant impact on the quality, safety or efficacy of the medicinal product, the MAH will be notified that the applied change cannot be handled as a Type IB and that the variation will have to be reclassified as a Type II variation. As a consequence, the MAH will be requested to revise and supplement its variation application so that the requirements for a Type II variation application are met.

Following receipt of the valid revised variation application, a Type II assessment procedure will be initiated according to the Agency procedural timetables for Type II variation.

When the Agency is of the opinion that the proposed variation can be considered a Type IB variation, the MAH will be informed of the outcome of the validation and of the start date of the procedure. The Type IB notification will be handled as set-out in section a) above.

### **c) Handling of Groupings of Minor Variations (Type IB/Type IA)**

For grouping of minor variations, where not all of the changes applied for can be positively validated, all valid and not valid variations will be clearly listed in the validation outcome correspondence.

Where a Type IB by default variation, within a group of variations, has to be reclassified as a Type II variation, the MAH will be requested to confirm whether this variation should remain in the group. If confirmed, the whole group will be handled as a Type II variation, as set out in b) above.

Where several Type IB variations are submitted as part of one notification, it will be clearly specified in the final Agency notification which variation(s) have been accepted or rejected following assessment, unless some of the variations have been withdrawn by the MAH during the procedure (see grouping Q&A).

## **2.8. What fee do I have to pay for a Type IB Variation? *Rev. Apr 2021***

For information on the fee applicable for Type IB variations, please refer to the explanatory note on fees payable to the European Medicines Agency. Such fee covers all authorised strengths, pharmaceutical forms and presentations of a given medicinal product.

For variations introducing additional presentation(s)/pack-size(s), each additional presentation/pack-size attracts separate fees ("X" additional presentations = "x" separate fees). Each presentation/pack-size should therefore be declared as a separate variation on the variation application form under the section 'Variations included in this application'.

Grouped Type IB variations, whether consequential or not, will each attract a separate Type IB fee.

The fee will become due on the date of the notification of the administrative validation to the applicant and fees will be payable within 45 calendar days of the date of the said notification. After approximately 15 days an invoice will be sent to the applicants billing address held on the Agency's file.

The invoice will contain details of the product and type of procedure involved, the fee amount, the financial information and the customer purchase order number associated with the procedures invoiced (if provided in the eSubmission delivery file). The Agency does not accept stand-alone notifications of purchase order numbers that are not associated with a dossier.

Guidance on how to pay an invoice can be found on our website.

### **References**

- Fees payable to the European Medicines Agency

## **2.9. Do I have to submit mock-ups and specimens? *Rev. Apr 2016***

For information concerning submission of mock-ups and specimens in the framework of post-authorisation procedures, please refer to section 3.4 Other post-authorisation procedures in the

document 'Checking process of mock-ups and specimens of outer/immediate labelling and package leaflet of human medicinal products in the centralised procedure.

## References

- The Checking Process of Mock-Ups and Specimens of outer/immediate labelling and package leaflets of human medicinal products in the Centralised Procedure (EMA/305821/2006)

## **2.10. How should I submit revised product information? In all languages? Rev. Apr 2021**

In case the Type IB notification affects any of the annexes, i.e. annex A, SPC, annex II, labelling and/or package leaflet, the affected revised product information Annexes must be submitted as follows:

### **a) For Type IB procedures without linguistic review of product information:**

At submission, the MAH should provide:

- within the eCTD sequence: complete set of annexes of the product information in all EEA languages in PDF (clean)
- electronically: complete set of annexes of the product information in all EEA languages in word (highlighted)

If Annex A is affected, please submit all EEA language versions in word (highlighted) electronically and in PDF (clean) in eCTD.

### **b) For Type IB procedures with linguistic review of product information:**

At submission, the MAH should provide:

- within the eCTD sequence: complete set of Annexes of the product information in EN (only) in PDF (clean)
- electronically: complete set of Annexes of the product information in all EEA languages in word (highlighted)

If Annex A is affected, please submit all EEA language versions in word (highlighted) electronically and in PDF (clean) in eCTD.

Please be reminded that in accordance with Union data protection requirements, no personal data should be included in the annotated product information annexes. This applies to the English version as well as all the other translation versions. Please submit annotated product information annexes in an anonymised format (i.e. names of the reviewers removed from the track-changes). If you do not wish to do so, please ensure that the individuals whose data is included consented to its sharing with EMA and its further sharing by EMA with third parties such as other marketing authorisation applicants, marketing authorisation holders and National Competent Authorities, as relevant. EMA expressly disclaims any liability or accountability for the presence of unnecessary personal data in the annotated product information annexes submitted by the marketing authorisation holder.

Upon validation of the procedure the MAH will receive the timetable for the submission of the translations of the product information for linguistic review.

In all cases the 'complete set of Annexes' includes Annex A (if applicable), I, II, IIIA and IIIB i.e. all authorised presentations (if applicable), SPC, labelling and PL texts for all strengths and pharmaceutical forms of the product concerned, as well as Annex II. The complete set of Annexes must be presented sequentially (i.e. Annex I, II, IIIA, IIIB) as one document for each official EU language. Page numbering should start with "1" (bottom, centre) on the title page of Annex I. The 'QRD Convention' published on the Agency website should be followed. When submitting the full set of Annexes in PDF format, this should be accompanied by the completed formatting checklist which provides guidance on how to correctly prepare the PDF versions.

The electronic copy of all languages should be provided as part of the variation application. Highlighted changes should be indicated via 'Tools – Track Changes'. Clean versions should have all changes 'accepted'.

Icelandic and Norwegian language versions must always be included.

The Annexes provided should only reflect the changes introduced by the Variation(s) concerned. However, in exceptional cases where MAHs take the opportunity to introduce minor linguistic amendments in the texts this should be clearly mentioned in the cover letter and in the scope section of the application form (see also "What can be considered an editorial change and how can it be submitted as part of a type IA/IB/II variation?").

In addition, the section "present/proposed" in the application form should clearly list the minor linguistic amendments introduced for each language. Alternatively, such listing may be provided as a separate document attached to the application form. Any changes not listed, will not be considered as part of the variation application.

In such cases and in cases where any other on-going procedure(s) may affect the product information Annexes, the MAH is advised to contact the Agency in advance of submission or finalisation of the procedure(s) concerned.

For Type IB **variations affecting Annex A** where the variation introduces a new EU sub-number, the sub-number should be included in the Annex A and in the product information texts as part of the variation application (see also "How to obtain new EU sub-numbers for a Type IB variation concerning an additional presentation? (e.g. new pack-size)?").

Similarly, in case of a deletion of a pharmaceutical form/strength(s), the amended Annex A and product information Annexes should be provided as part of the Variation application.

### **2.11. What changes will trigger new EU number(s) (additional presentation(s))? *Rev. Feb 2021***

Any changes in the number of units of medicinal product or medical device being an integral part of the medicinal product (e.g. prefilled syringes) will trigger a different EU number.

Differentiation should be made between the addition of a presentation where the two presentations will co-exist on the market on a long-term basis versus a replacement of a presentation where the new presentation will replace the previous one (it is expected that for a certain period of time, the two presentations will co-exist on the market until the stock of the previous presentation runs out).

In principle, a **replacement** of one presentation by another presentation does not trigger a new EU number, unless the number of units of medicinal product or medical device being an integral part of the medicinal product (e.g. prefilled syringes) is changed.

Examples of changes in presentations for replacement, not triggering a new EU number (this is not an exhaustive list):

- Replacement of the primary or secondary packaging,
- Changes in the number of medical devices not being integral part of the medicinal product,
- Change in composition (e.g. change in excipients),
- Change in units per blisters (without change to the total number of units per pack).

Examples of changes in presentations for replacement, triggering a new EU number (this is not an exhaustive list):

- 30 to 60 tablets,
- 2 prefilled syringes containing the medicinal product instead of one prefilled syringe.

In case of **addition**, as the presentations will co-exist on the market, two packs with different contents cannot be covered by the same EU number and will be considered as different presentations.

Changes in the number of any unit (not restricted to the medicinal product) or changes in the specifications of any unit (not restricted to the medicinal product) contained in the pack will trigger a new EU number.

Examples of changes that will trigger new EU numbers (this is not an exhaustive list):

- Introduction of an alternative injection kit with a different number of syringes or swabs,
- Introduction of an alternative syringe of different volume or an alternative syringe with a needle guard,
- Introduction of an alternative immediate (primary) packaging made from a different material,
- Introduction of an alternative shape/dimension of a pharmaceutical form (pre-rolled sealant matrix versus flat, change in size of patch).

## **2.12. How to obtain new EU sub-numbers for a Type IB variation concerning an additional presentation (e.g. new pack-size)? *Rev. Feb 2021***

In the specific case of a Type IB Variation for an additional presentation, the new EU marketing authorisation sub-number should be requested from the Agency before submission.

The request should be sent together with a checklist and a draft Annex A (in English only) through the EMA Service Desk, using the Question option. The Type of question to be selected is "Post-authorisation queries" followed by sub-option "New EU number". The request should be made at least 5 working days in advance of the intended submission of the variation. Once a number has been allocated, this number should subsequently be included in the Annex A and Product Information Annexes submitted together with the Variation notification.

### **2.13. How and when will the updated Annexes become part of the Marketing Authorisation? Rev. Oct 2012**

For type IB variations affecting the annexes to the Commission Decision, the Commission Decision will generally be updated within one year, unless the Type IB variation concerns any of the changes listed in Article 23.1a(a) whereby the Commission Decision will be updated within two months. This would include variations related to the addition of a new therapeutic indication or modification of an existing one, addition of a new contraindication or change in posology. It is expected that such variations would be processed as Type IB variations mainly in the framework of generics/hybrids following changes to the product information of the reference medicinal product.

However, all Type IB variations affecting the annexes can be implemented without awaiting the update of the marketing authorisation and the agreed Type IB changes should be included in the Annexes of any subsequent Regulatory Procedure.

For type IB variations subject to yearly update of the respective Commission decision, at the end of this yearly period, the Agency will send the complete set of Annexes, based on the latest approved Annexes and reflecting the Type IB change(s) introduced during the past year as well as a line-listing of those variations pending update of the Commission decision.

Where a notification contained several Type IB variations concerning one marketing authorisation, the Commission will update the marketing authorisation with one single decision to cover all the approved minor variations.

However, where a notification/opinion affecting the Annexes which is followed by an immediate Commission decision, is transmitted to the Commission within this yearly period, the changes of the Type IB notification(s) concerned will already be included in the Annexes to the notification/opinion and will consequently be reflected in the resulting Commission Decision. This Commission Decision will therefore replace the yearly updating of the MA for the Type IB notification(s) concerned.

At the occasion of a next Type IB variation affecting the Annexes, the procedure outlined above will be repeated based on the new 'Reference point' of the next Type IB concerned.

(see also diagram below)



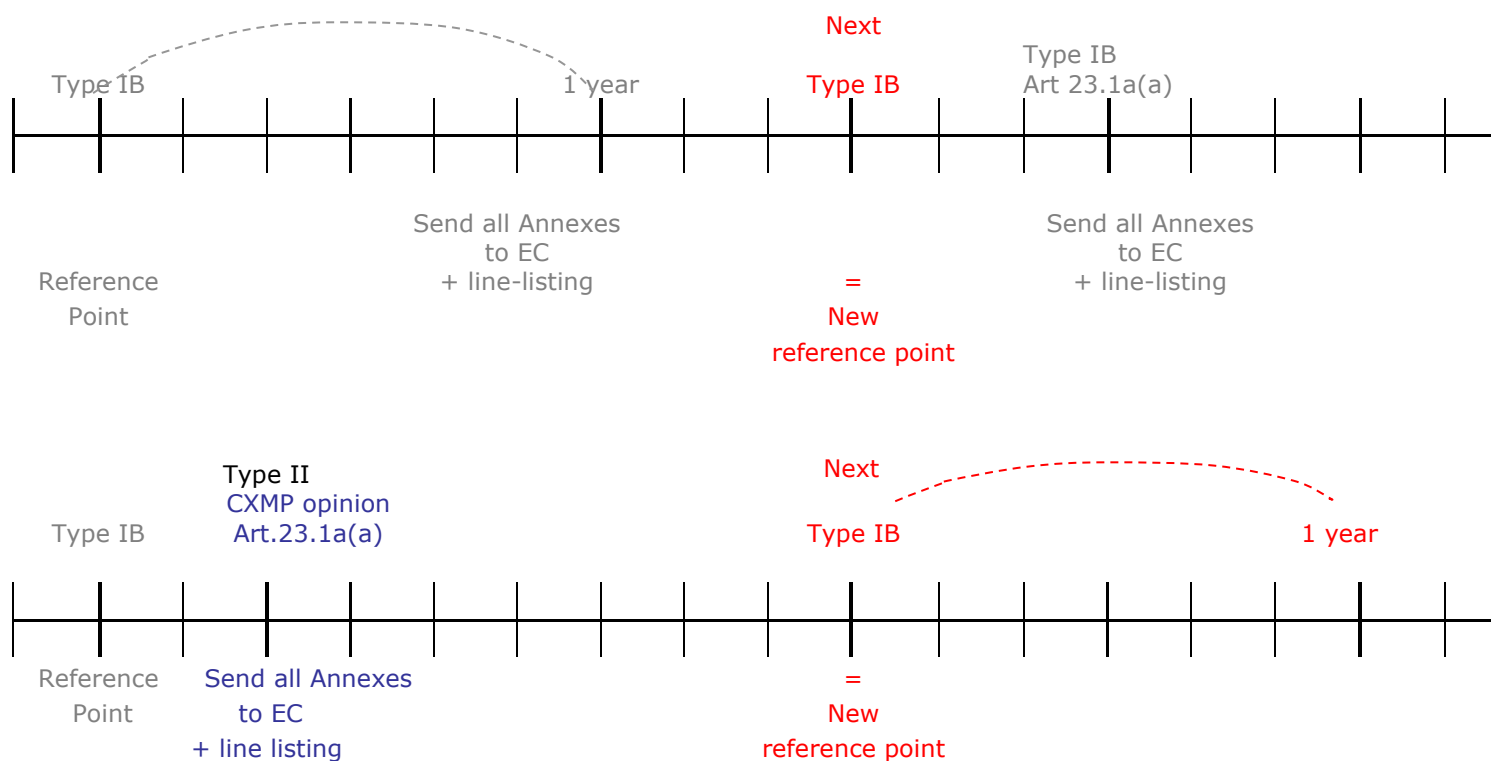

## 2.14. Who should I contact if I have a question when preparing my application or during the procedure? **Rev. Feb 2021**

If you cannot find the answer to your question in the Q&A when preparing your application, please raise a ticket via the EMA Service Desk, using the Question option. The Type of question to be selected is "Post-authorisation queries", followed by sub-option "Variation IB A&B scopes" or "Variation IB C scopes".

The Agency aims to respond to your query within 10 working days. To help us deal with your enquiry, please provide as much information as possible including the name of the product in your correspondence.

You should submit your query once and it is important that you submit it using the applicable type of question and sub-option. If you are uncertain of a classification of a variation as type IB or type IA please use only one of the sub-option "Variation IA" or "Variation IB A&B scopes" or "Variation IB C scopes". If you seek advice on the classification of change(s), please include your proposal for classification. Your query will be channelled internally to the relevant service(s) that will respond to you.

If you do not have an EMA Account, you may create one via the EMA Account Management portal.

Type IB variations will be handled by a dedicated team of Procedure Managers (PM). A PM will be nominated upon receipt of the variation. You will be able to contact this PM throughout the procedure.

## 3. Type II variations

### 3.1. What changes considered Type II variations? *Rev. Dec 2016*

Commission Regulation (EC) No 1234/2008 ('the Variations Regulation') defines a major variation of Type II as a variation which is not an extension of the Marketing Authorisation (line extension) and that may have a significant impact on the quality, safety or efficacy of a medicinal product.

The Variations Regulation and the Variations Guidelines set out a list of changes to be considered as Type II variations. In addition, any other change which may have a significant impact on the quality, safety or efficacy of the medicinal product must be submitted as a Type II variation. Please refer also to "When will my variation application be considered a Type II variation or an extension application?".

During validation of an 'unforeseen' variation, submitted by the MAH as a Type IB variation, the Agency may consider that the proposed variation may have a significant impact on the quality, safety or efficacy of the medicinal product. In such case, the marketing authorisation holder will be requested to revise and supplement its variation application so that the requirements for a Type II variation application are met (see "How shall my Type IB variations be handled (timetable)?").

#### References

- Regulation (EC) No 726/2004
- Commission Regulation (EC) No 1234/2008 (OJ L334 of 12 December 2008)
- Commission Regulation (EU) No 712/2012 amending Regulation (EC) No 1234/2008 concerning the examination of variations to the terms of marketing authorisations for medicinal products for human use and veterinary medicinal products
- Guidelines on the details of the various categories of variations, on the operation of the procedures laid down in Chapters II, IIa, III and IV of Commission Regulation (EC) No 1234/2008 of 24 November 2008 concerning the examination of variations to the terms of marketing authorisations for medicinal products for human use and veterinary medicinal products and on the documentation to be submitted pursuant to those procedures (so-called "Variations Guidelines")
- CMDh recommendation for classification of unforeseen variations according to Article 5 of Commission Regulation (EC) 1234/2008

### 3.2. Do I need to notify the Agency of my intention to submit a Type II variation application? *Rev. Feb 2019*

There is generally no requirement to notify the Agency in advance of an upcoming submission of a type II variation. For type II variations entailing additions of new therapeutic indication(s) or modification of already approved one(s) under scope C.I.6, due to the substantial amount of data expected, the assessment timeframe is typically longer (see also question "How shall my Type II application be handled (timetable)") and significant assessment resources need to be committed by the Rapporteur and usually also from the Co-Rapporteur (see also question "Is the Co-Rapporteur involved in Type II Variations"). For this reason, MAHs are requested to give an advance notice of their intention to submit an extension of indication or other changes to the authorised therapeutic indication ideally 6 months in advance of the planned submission. This can be achieved by means of an email to the Product Lead,

the Rapporteur, Co-Rapporteur and, if applicable, PRAC Rapporteur, summarising the scope of the intended application and specifying the target submission date. The information will be used for planning purposes by the Agency and the Rapporteurs' assessment teams.

### **3.3. Which Committee will take the lead in the assessment of a type II variation? *NEW Dec 2019***

The CHMP leads the assessment of most type II variations and always adopts the final Opinion for type II variations.

However, in case of type II variations concerning clinical safety to update the product information and/or the Risk Management Plan upon request by the PRAC, as a follow-up to a previous PSUR procedure or following a previous PRAC assessment of a signal, the PRAC will take the lead in the assessment of the variation.

It should be noted that the CHMP will lead the assessment of a post-PSUR variation where the scope is related to other aspects of the dossier e.g. non-clinical data, clinical pharmacology and/or clinical efficacy. In addition, the PRAC will lead in the assessment of type II variations:

- Specifically intended to update the RMP;
- Or providing final results of non-interventional post-authorisation safety studies (PASS).

The latter refers to both imposed (PASS category 1 and 2 in the RMP) and requested non-interventional studies (PASS category 3 in the RMP), and regardless of whether or not consequential changes to the product information are proposed.

It should be noted that final results of imposed non-interventional studies are expected to be submitted under the Art 107q of Directive 2001/83/EC procedure (please also refer to guidance on post-authorisation safety studies). Please also refer to "How should non-clinical and/or clinical study reports be provided?" for further guidance on the submission of PASS results.

Whether the CHMP or the PRAC will take the lead in the assessment of the variation will be decided at the time of the validation and communicated to the applicant through the assessment timetable.

It should be noted that the CAT, instead of the CHMP, will take the lead in the assessment of type II variations for advanced therapy medicinal products (ATMPs), unless these are PRAC-led. The CAT will adopt a draft Opinion for all type II variations for ATMPs, including for PRAC-led ones, with the CHMP adopting the final Opinion.

### **3.4. Is the Co-Rapporteur involved in Type II Variations? *Rev. Dec 2019***

The CHMP (or CAT for ATMPs) Co-Rapporteur is normally not involved in the assessment of a type II variation application concerning quality, non-clinical and clinical including product information changes and RMP updates.

However, the involvement of the CHMP Co-Rapporteur is in most cases deemed necessary for the assessment of a new therapeutic indication or modification of an approved indication (i.e. type II variations under category C.I.6.a).

The MAH should therefore inform the Agency (Product Lead) of an upcoming type II application for a new indication at least 2 months before submission, so that the CHMP is informed of the future submission and can agree on the Co-Rapporteur's involvement.

At the time of validation, the Agency will inform the MAH of the involvement of the CHMP Co-Rapporteur through the assessment timetable which will refer to the relevant assessment reports expected from the Co-Rapporteur as appropriate.

Regarding the submission of a type II variation application to the (Co-) Rapporteurs, please see also question "How and to whom shall I submit my Type II Variation application" below.

### **3.5. Is the PRAC Rapporteur involved in type II variations? Rev. Dec 2019**

As explained in the question "Which Committee will take the lead in the assessment of a type II variation?" above, the PRAC Rapporteur is involved in and performs the primary assessment of PRAC-led variations.

In addition, the PRAC Rapporteur will systematically be involved in the assessment of all CHMP-led type II variations that include an updated RMP for the purposes of assessing the proposed RMP changes.

The CHMP may also on a case-by-case basis involve the PRAC Rapporteur in the assessment of other type II variations during the assessment procedure, e.g. variations involving a Direct Healthcare Professional Communication, following a CHMP request for formal PRAC advice, i.e. input from PRAC on particular safety issues and in response to specific questions raised by the CHMP.

### **3.6. Can I group the submission of type II variations? Can they be grouped with other types of variations? Rev. Feb 2015**

Marketing authorisation holders may choose to group the submission of several Type II variations for the same product into one application, provided that this corresponds to one of the cases listed in Annex III of the Variations Regulation or when this has been agreed upfront with the Agency.

It is also possible for a marketing authorisation holder to group a Type II variation with other variation(s) (e.g. Type IB or IA variations) or extension applications. Such grouped submissions will follow the assessment timetable of the highest variation in the group. Please also refer to "What types of variations can be grouped?".

Where the same Type II variation(s) affect(s) one or more marketing authorisations from the same holder, the marketing authorisation holder may choose to submit these variations as one application for 'worksharing'. Please also refer to "What is worksharing and what types of variations can be subject to worksharing?".

#### **References**

- Commission Regulation (EC) No 1234/2008 (OJ L334 of 12 December 2008)
- Commission Regulation (EU) No 712/2012 amending Regulation (EC) No 1234/2008 concerning the examination of variations to the terms of marketing authorisations for medicinal products for human use and veterinary medicinal products

- Guidelines on the details of the various categories of variations, on the operation of the procedures laid down in Chapters II, IIa, III and IV of Commission Regulation (EC) No 1234/2008 of 24 November 2008 concerning the examination of variations to the terms of marketing authorisations for medicinal products for human use and veterinary medicinal products and on the documentation to be submitted pursuant to those procedures (so-called “Variations Guidelines”)

### **3.7. How shall I present my type II Variation application? Rev. Jul 2021**

A type II variation application should contain the elements listed in Annex IV of the Variations Regulation and should be presented in accordance with the appropriate headings and numbering of the EU-CTD format.

In addition, the MAHs are strongly recommended to complete the relevant validation checklist (Clinical/No-clinical or quality) and submit it as a word document (working document) in Module 1 as an Annex. The checklist will help MAHs to ensure that their type II variations are complete and in compliance with legal and regulatory requirements, leading to a smoother validation.

The Commission ‘Variations Guidelines’ further specifies which elements should be included in a Type II variation application. More specifically, a type II variation application should contain the following elements:

#### Module 1

- **Cover letter** (for groupings, include a short overview of the nature of the changes and indicate whether it is submitted under Article 7.2(b), i.e. it falls within one of the cases listed in Annex III of the variations regulation or it is submitted under Article 7.2.(c), i.e. the grouping has been agreed with the Agency).
- In order to facilitate the registration of the submission, marketing authorisation holders are required to fill in all the submission attributes through the eSubmission delivery file UI.
- If the variation addresses a specific post-authorisation measure (PAM), the applicant should refer to the PAM reference number in the cover letter, application form and clinical and/or non-clinical overview, as appropriate. In case the reference number for the PAM has not been confirmed by the Agency, a description of the commitment/measure is sufficient at time of submission.
- The applicant may provide relevant documents as attachments to the cover letter, e.g. Agency requests for variations implementing changes for generic/hybrid/biosimilar medicinal products, CHMP PAM assessment reports, PRAC PSUSA assessment reports and Scientific Advice letters etc.
- **Procedure number** – The procedure number will be assigned by the EMA only upon receipt of an eCTD application and does not need to be included by the applicant at the time of submission. For further details refer to EMA pre-submission guidance “How is an EMA application/procedure number attributed?”
- The completed electronic EU variation **application form** (eAF) including the details of the marketing authorisation(s) concerned. Where a variation leads to or is the consequence of other variations, a description of the relation between these variations should be provided in the appropriate section of the application form. All proposed changes should be declared in the ‘**Type of changes**’ section of the form, and clearly described in the ‘**scope**’ section of the form.

- The '**present/proposed**' section in the application form should reflect all proposed changes to the English Product Information (SmPC, Annex II, labelling and package leaflet) as current and proposed text. Alternatively, if the proposed changes are extensive the applicant may instead provide the 'present/proposed' comparison as part of a separate annex to the application form. In this case, the applicant should include in the 'present/proposed' section of the application form a cross-reference to this annex.
- Presenting all changes in a 'present/proposed' format is a mandatory requirement in addition to the updated Product Information provided in module 1.3.1 (see below).
- For type II variations concerning quality changes, the 'present/proposed' table (or attachment) should reflect all changes applied for. Dossier section numbers should be provided to the lowest level possible and, where feasible, include the precise current and proposed wording as reflected in the relevant sections of the dossier. Where this is not feasible, a summary of the change(s) applied for should be included in the section.
- Reference to the variation scope laid down in the 'Variations Guidelines' or reference to the published Article 5 recommendation, if applicable, should be made. The extract(s) of the 'Variations Guidelines' should preferably be submitted as a separate annex in module 1.2. In case of groupings the corresponding classification scopes should be indicated as many times as needed taking into account that one classification scope is to be indicated per variation.
- Module 1.3.1 – In case changes to the Product Information are proposed, a revised full set of annexes (SmPC, Annex II, labelling and package leaflet) should be provided in English. The application must include clean and highlighted versions of the annexes, clearly showing all proposed amendments in track changes. The clean version should be provided as a PDF document in module 1.3.1 and the highlighted version preferably as a word document as part of the 'working documents' outside the eCTD structure. In addition, the proposed Product Information should always be included in the eCTD submission as a pdf version with track changes, as a comparison of the present and proposed wording in the application form and/or as an attachment to the application form. Please also refer to Question "When do I have to submit revised product information? In all languages?" below.
- Module 1.4.1 – Information about the **quality expert** (signed and dated expert statement + CV) is mandatory for all type II variations including or referring to quality data in module 3. The quality expert is accountable for the quality overview/addendum (see below in section on Module 2).
- Module 1.4.2 – Information about the **non-clinical expert** (signed and dated expert statement + CV) is mandatory for all type II variations including or referring to non-clinical data. The non-clinical expert is accountable for the non-clinical overview/addendum (see below in section on Module 2).
- Module 1.4.3 - Information about the **clinical expert** (signed and dated expert statement + CV) is mandatory for all type II variations including or referring to clinical data and/or applications including an updated version of the Risk Management Plan (RMP). The clinical expert is accountable for the clinical overview/addendum (see below in section on Module 2).
- Module 1.5.3 – When the applicant requests consideration of an additional year of market protection in accordance with Article 14(11) of Regulation (EC) No 726/2004 or an additional year of data protection in accordance with Article 10(5) of Directive 2001/83/EC, a report should be provided in this module. For further details on the content of the report, reference should be made to Eudralex Volume 2B for the Commission 'Guidance on elements required to support the

significant benefit in comparison with existing therapies of a new therapeutic indication in order to benefit from an extended (11 years) marketing protection period' or 'Guidance on a new therapeutic indication for a well-established substance'.

- Module 1.8.2 - **updated RMP** (with revision date and version number) if applicable. When an updated RMP is proposed, the application should include both a clean and highlighted version of the revised RMP, clearly showing all proposed changes in track changes. All parts and modules of the clean RMP should be submitted in one single PDF-file. The highlighted version should also be provided as a word document in the 'working documents' outside the eCTD structure (see below). Please also refer to "Risk Management Plan (RMP): questions and answers".
- **Working documents** outside the eCTD structure: Additional Word formats of certain documents are required to facilitate the assessment i.e. 'tracked changes' versions for SmPCs, RMPs or other documents specified by the Agency. These should be provided in the separate folder 'XXXX-working documents'. Further details can be found in the Harmonised Guidance for eCTD Submissions in the EU. It is generally not necessary to include the RMP annexes in the 'working document' version (unless annexes are being revised).
- Module 1.9 – if applicable - Statement indicating that clinical trials conducted outside the EU meet the **ethical requirements** of Directive (EC) No 2001/20/EC, together with a listing of all trials (protocol numbers), and third countries involved. This is relevant when clinical trial reports are submitted.

## Module 2

- Module 2.3 – Update or addendum to the **quality summary**. A quality summary is mandatory for all quality type II variations. The document should discuss the data provided and address the impact on the Product Information (if any) and on the overall benefit/risk balance.
- Module 2.4 - Update or addendum to the **non-clinical overview**. A non-clinical overview /addendum is mandatory for all non-clinical type II variations regardless of the impact on the Product Information. The document should discuss the data provided, address the impact on the Product Information and/or the RMP (if any), and conclude on the impact on the overall benefit/risk balance.
- Module 2.5 – Update or addendum to the **clinical overview**. A clinical overview/addendum is mandatory for all clinical type II variations regardless of the impact on the Product Information. The document should discuss the data provided, address the impact on the Product Information and/or the RMP (if any), and conclude on the impact on the overall benefit/risk balance. It should be noted that a clinical overview/addendum is mandatory also for type II variations that only concern an update of the RMP.
- Module 2.6 – **Non-clinical summary(ies)**. Whenever non-clinical study reports are provided, even if only one, relevant non-clinical summary(ies) are mandatory.
- Module 2.7 – **Clinical Summary(ies)**. Whenever clinical study reports for interventional studies are submitted, even if only one, relevant clinical summary(ies) are mandatory. However, it should be noted that summaries are not required for non-interventional studies.

## Modules 3, 4 and 5

- Supporting quality, non-clinical and/or clinical data/study reports relating to the proposed variation(s), including literature references, should be provided.

The applicant can cross refer to information already included in the same dossier by using hyperlinks in modules 3, 4 and/or 5 rather than re-submitting the data again.

See also “How should I present a grouped-variation application?” and “How should I present a variation application under worksharing?”

It should be noted that the responsibility for the quality of the submitted documentation lies with the MAH and is crucial to the overall process.

For queries relating to the presentation of the application, please contact the Agency (allocated Product Lead).

## References

- Regulation (EC) No 726/2004
- Commission Regulation (EC) No 1234/2008 (OJ L334 of 12 December 2008)
- Commission Regulation (EU) No 712/2012 amending Regulation (EC) No 1234/2008 concerning the examination of variations to the terms of marketing authorisations for medicinal products for human use and veterinary medicinal products
- Guidelines on the details of the various categories of variations, on the operation of the procedures laid down in Chapters II, IIa, III and IV of Commission Regulation (EC) No 1234/2008 of 24 November 2008 concerning the examination of variations to the terms of marketing authorisations for medicinal products for human use and veterinary medicinal products and on the documentation to be submitted pursuant to those procedures
- Electronic Variation application form
- Harmonised Guidance for eCTD Submissions in the EU

### **3.8. How shall I present my application for a new or modified therapeutic indication? *Rev. Jul 2021***

The MAHs are strongly recommended to complete the relevant validation checklist (Clinical/No-clinical or quality) and submit it as a word document (working document) in Module 1 as an Annex. The checklist will help MAHs to ensure that their type II variations are complete and in compliance with legal and regulatory requirements, leading to a smoother validation.

In addition to the requirements foreseen in the question above, the following considerations specifically apply to applications concerning a new or a modified indication (please refer to question ‘What is considered a new or modified therapeutic indication?’):

- The sections in the application form on **orphan** medicinal products and **paediatric** requirements should be completed for all type II variation applications under category C.I.6.a that concern a new indication. In case of doubt, advice can be requested from the Agency in advance of the submission.

Please also refer to Q&As on ‘What aspects should I consider at time of submission of a type II variation if there are orphan medicinal products designated or authorised for a condition related to my proposed therapeutic indication?’, ‘Do I need to confirm the maintenance of my orphan designation when applying for a type II variation?’, ‘Can a non-orphan therapeutic indication be



added to an already authorised orphan medicinal product?’ and ‘Do I need to address any paediatric requirements in my type II variation application?’.

- Module 1.3.4 - Consultation with **target patient groups** (user testing results) or a justification why this was not considered necessary should be provided for all type II variation applications under category C.I.6.a.
- Module 1.6 – **Environmental Risk Assessment (ERA)**, where applicable. Expert assessment with or without study report(s) or justification why not considered necessary and the CV and signature of the expert should be provided for all type II variation applications under category C.I.6.a.
- Module 1.7.1 – **Similarity assessment**, as applicable. See above and also refer to Q&A ‘What aspects should I consider at time of submission of a type-II variation if there are orphan medicinal products designated or authorised for a condition related to my proposed therapeutic indication?’.
- Module 1.8.2 - **Updated RMP** (with revision date and version number) or justification where not considered necessary should be provided for all type II variations applications under category C.I.6.a. The justification, where applicable, should be included in module 1.8.2 or alternatively in the cover letter and/or the clinical overview.
- Module 1.10 – **Paediatric information** – if applicable - should be provided for all type II variation applications under category C.I.6.a that concern a new indication. In case of doubt, advice can be requested from the Agency in advance of the submission.

Applicants are strongly advised to include the summary of the main efficacy results as part of the ‘working documents’ outside the eCTD structure. Provision of this document would facilitate the scientific assessment by the relevant scientific bodies. Further details can be found in the Harmonised Guidance for eCTD Submissions in the EU.

Please also refer to the following questions which address paediatric related aspects ‘Do I need to address any paediatric requirements in my type II variation application?’ and ‘What is considered a new or modified therapeutic indication?’.

#### **References**

- Harmonised Guidance for eCTD Submissions in the EU
- Table of summary of the main efficacy results template

### ***3.9. How and to whom shall I submit my Type II Variation application? Rev. Feb 2019***

Information is available on ‘Submitting a post-authorisation application’.

### ***3.10. When shall I submit my type II variation? Rev. Dec 2019***

The assessment timetable and hence the submission deadline applicable to a type II variation application depends on the committees involved in the assessment, the amount of assessment needed

and whether the CHMP Opinion will be followed by an amendment of the Commission Decision granting the Marketing Authorisation within two months.

There are two types of submission deadlines and consequently procedure start dates: monthly and weekly once.

Weekly starts are applicable to the majority of the type II variation applications received by the Agency. The following minority of type II variations applications follow a monthly start date:

- extensions of indications and other variations requiring amendment of the Commission Decision granting the Marketing Authorisation within two months from CHMP Opinion. Please refer to Question 'Which post-opinion steps apply to my Type II variation and when can I implement the approved changes?' below.
- variations involving multiple committees, i.e. PRAC, CAT in addition to the CHMP (e.g. variations including an RMP update or variations for ATMPs).

Specific monthly start dates apply for variations involving the PRAC. Opinions for monthly start variations requiring Commission Decision within two months from CHMP Opinion (including extensions of indication) are adopted during the week of the CHMP plenary meeting. Opinions for monthly start variations involving the PRAC and **not** requiring Commission Decision within two months are adopted during the week of the PRAC plenary meeting. Opinions for weekly start variations are adopted independently of the committee plenary meetings.

For variations following the weekly start, the Agency may need to amend the timetable if during the procedure the need for discussion at plenary / involvement of other committees (e.g. PRAC), working parties (i.e. BWP) or for immediate EC decision arise.

In case there is uncertainty before submission as to which timetables and submission deadlines are to be followed, MAHs can request the advice of the Agency by contacting the allocated Product Lead. The Agency will inform the MAH of the applicable timetable in the validation confirmation e-mail. For more information see also *question 'How shall my Type II application be handled (timetable)?'*.

For both weekly-start and monthly-start assessment timetables, the MAH should submit their application at the latest by the recommended submission dates published on the Agency's website (Please refer to "Human Medicines – Procedural Timetables / Submission dates").

MAHs are reminded of their legal obligation to submit forthwith any information that becomes available which might entail the variation of the MA.

Where the CHMP requests the submission of a variation following the assessment of a post-authorisation measure (PAM), Specific Obligation (SO) or signal, MAHs must submit the corresponding variation application within the requested timeframe.

Variation applications reflecting the outcome of an Urgent Safety Restriction (USR) shall be submitted immediately and in any case no later than 15 days after the initiation of the USR to the Agency. This applies to USRs initiated by the MAH or imposed by the European Commission.

Implementation of agreed wording changes following the above-mentioned procedures for which no additional data are submitted by the MAH will follow a Type IB variation procedure.

## References

- Regulation (EC) No 726/2004

- Commission Regulation (EC) No 1234/2008 (OJ L334 of 12 December 2008)
- Commission Regulation (EU) No 712/2012 amending Regulation (EC) No 1234/2008 concerning the examination of variations to the terms of marketing authorisations for medicinal products for human use and veterinary medicinal products
- Guidelines on the details of the various categories of variations, on the operation of the procedures laid down in Chapters II, IIa, III and IV of Commission Regulation (EC) No 1234/2008 of 24 November 2008 concerning the examination of variations to the terms of marketing authorisations for medicinal products for human use and veterinary medicinal products and on the documentation to be submitted pursuant to those procedures

### **3.11. How shall my Type II application be handled (timetable)? *Rev. Feb 2019***

Upon receipt of a technically valid application, the Product Lead will perform the validation of the application content. Supplementary information may be requested in order for the validation to be finalised and the procedure will commence at the next available start date after resolution of issues identified during validation. The Agency will inform the MAH of the outcome of the validation and timetable (TT).

Assessment of type II variations following a 60-day timetable may either follow a weekly or a monthly start date, depending whether the CHMP plenary meeting periodicity needs to be observed or not (See also question “*When shall I submit my application?*” above).

Extensions of indication on a 90-day timetable always follow the monthly start timetable as they require Commission Decision within two months from CHMP Opinion and discussion during the CHMP plenary meeting.

The majority of type II variation procedures following a 30-day timetable (e.g. urgent safety issues) will most commonly follow the monthly start timetable. This is because they are likely to require Commission Decision within two months from CHMP Opinion and discussion during the CHMP plenary meeting.

For variations following a weekly-start timetable, the opinion or request for supplementary information will be adopted by the CHMP independently of the plenary meetings. The MAH can also provide their responses to a request for supplementary information during the procedure in line with the weekly re-start dates.

#### **Variations following a 60-day TT (= standard timetable)**

Condition:

- All Type II variations, i.e. excluding those qualifying for a 30- or 90-day TT (see below)

Variations assessed by the CHMP only or variations involving the PRAC (refer to question ‘Is the PRAC Rapporteur involved in Type II Variations?’) not requiring Commission Decision within two months from CHMP Opinion

Day	Action
Day 1	Start of evaluation
Day 36	Receipt of CHMP# Rapporteur's Assessment Report
Day 43^	Receipt of PRAC Rapporteur's Assessment Report
Day 47^	Comments by other PRAC members
Day 50	Comments by other CHMP members
Day 51^	Receipt of PRAC Rapporteur's updated Assessment Report*
Day 53	Receipt of CHMP# Rapporteur's updated Assessment Report*
Day 58^	PRAC outcome
Day 60	Adoption of the CHMP Opinion <i>[or Request for supplementary information]</i>

\*Updated assessment reports are optional, depending on comments received by other committee members.

#There is(are) no CHMP Rapporteur's assessment report(s) in case of PRAC-led variations.

^Steps not applicable for CHMP-only variations.

Variations assessed by PRAC (refer to question 'Is the PRAC Rapporteur involved in Type II Variations?') and CHMP requiring Commission Decision within two months from CHMP Opinion:

Day	Action
Day 1	Start of evaluation
Day 30	Receipt of CHMP Rapporteur's Assessment Report
Day 33	Receipt of PRAC Rapporteur's Assessment Report
Day 38	Comments by other PRAC members
Day 39	Receipt of PRAC Rapporteur's updated Assessment Report*
Day 46	PRAC outcome
Day 50	Comments by other CHMP members
Day 53	Receipt of CHMP Rapporteur's updated Assessment Report*
Day 60	Adoption of the CHMP Opinion <i>[or Request for supplementary information]</i>

\* Updated assessment reports are optional, depending on comments received by other committee members.

## Variations following a 30-day TT

Condition:

- Changes which, in the opinion of the Committee, would benefit from a shortened assessment having regard to the urgency of the matter in particular for safety issues

Variations assessed by the CHMP only or variations involving the PRAC (refer to question 'Is the PRAC Rapporteur involved in Type II Variations?') not requiring Commission Decision within two months from CHMP Opinion:

Day	Action
Day 1	Start of evaluation
Day 15	Receipt of CHMP <sup>#</sup> Rapporteur's Assessment Report
Day 17 <sup>^</sup>	Receipt of PRAC Rapporteur's Assessment Report
Day 20 <sup>^</sup>	Comments by other PRAC members
Day 20	Comments by other CHMP Members
Day 21 <sup>^</sup>	Receipt of PRAC Rapporteur's updated Assessment Report*
Day 23	Receipt of CHMP <sup>#</sup> and PRAC Rapporteur's updated Assessment Report*
Day 28 <sup>^</sup>	PRAC outcome
Day 30	Adoption of the CHMP Opinion <i>[or Request for supplementary information]</i>

\*Updated assessment reports are optional, depending on comments received by other committee members.

<sup>#</sup>There is(are) no CHMP Rapporteur's assessment report(s) in case of PRAC-led variations.

<sup>^</sup> Steps not applicable for CHMP-only variations.

Variations assessed by PRAC (refer to question 'Is the PRAC Rapporteur involved in Type II Variations?') and CHMP requiring Commission Decision within two months from CHMP Opinion:

Day	Action
Day 1	Start of evaluation
Day 6	Receipt of PRAC Rapporteur's Assessment Report
Day 8	Comments by other PRAC Members
Day 9	Receipt of PRAC Rapporteur's updated Assessment Report*
Day 15	Receipt of CHMP Rapporteur's Assessment Report

Day	Action
Day 16	PRAC outcome
Day 20	Comments by other CHMP Members
Day 23	Receipt of CHMP Rapporteur's updated Assessment Report*
Day 30	Adoption of the CHMP Opinion <i>[or Request for supplementary information]</i>

\* Updated assessment reports are optional, depending on comments received by other committee members.

In exceptional cases, this timetable could be further shortened.

### Variations following a 90-day TT

Condition:

- For variations concerning changes to or addition of therapeutic indications or for grouped variation agreed with the Agency

Day	Action
Day 1	Start of evaluation
Day 56	Receipt of and CHMP (Co-) Rapporteur's Assessment Report
Day 63 <sup>^</sup>	Receipt of PRAC Rapporteur's Assessment Report
Day 68	Comments by other PRAC members <sup>^</sup>
Day 69 <sup>^</sup>	Receipt of PRAC Rapporteur's updated Assessment Report
Day 76 <sup>^</sup>	PRAC outcome
Day 80	Comments by other CHMP members
Day 83	Receipt of CHMP Rapporteurs' Joint Assessment Report
Day 90	Adoption of the CHMP Opinion <i>[or Request for supplementary info]</i>

<sup>^</sup>The PRAC is normally involved in the assessment of type II variation applications following the 90-day TT because these are usually extensions of indication for which an (updated) RMP is normally expected to be submitted as part of the application. Absence of an RMP update should be justified at the time of submission.

In case issues which prevent the adoption of an Opinion are identified, the CHMP will adopt a request for supplementary information together with a deadline for submission of the requested data by the MAH and a timetable for the assessment of the MAH's responses. The MAH will receive the adopted

timetable together with the request for supplementary information. The clock will be stopped until the receipt of the requested supplementary information.

Any response to a request for supplementary information must be sent to the Agency, the (Co) Rapporteur and all CHMP members, as well as PRAC members where appropriate.

In certain cases, the MAH may be able to respond within a few days from the CHMP adoption of the request for supplementary information. In such cases provided that the assessment of the MAH's responses could be dealt with in 30 days, an Opinion (or additional request for supplementary information) could be adopted at the next CHMP plenary meeting. For variations following the weekly-start timetable, clock-stops in increments of weeks i.e. shorter than one month can apply. Usually, MAHs will require a clock-stop of one month in order to prepare the responses to the request for supplementary information. For clock-stops longer than 1 month the MAH should send a justified request to the EMA for agreement by the Rapporteur (and if the Rapporteur considers it necessary, by the CHMP). Such requests should ideally be sent at the latest before the adoption of the request for supplementary information. However, a request for an extension of the adopted response timetable can also be submitted during the clock-stop period after the applicant has received the adopted CHMP request for supplementary information but before the expected submission date for the responses.

The CHMP assessment of responses will take up to 30 or 60 days depending on the complexity and amount of data provided by the MAH. Upon receipt of the responses from the MAH, the procedure will be re-started following a weekly-start or monthly-start timetable according to the same principles as the ones applied at the initial start of procedure.

An oral explanation to the CHMP can be held at the request of the CHMP or the MAH, where appropriate.

## References

- Regulation (EC) No 726/2004
- Commission Regulation (EC) No 1234/2008 (OJ L334 of 12 December 2008)
- Commission Regulation (EU) No 712/2012 amending Regulation (EC) No 1234/2008 concerning the examination of variations to the terms of marketing authorisations for medicinal products for human use and veterinary medicinal products
- Guidelines on the details of the various categories of variations, on the operation of the procedures laid down in Chapters II, IIa, III and IV of Commission Regulation (EC) No 1234/2008 of 24 November 2008 concerning the examination of variations to the terms of marketing authorisations for medicinal products for human use and veterinary medicinal products and on the documentation to be submitted pursuant to those procedures

### **3.12. How should parallel type II variations that affect the product information be handled? *NEW Dec 2016***

When two or several stand-alone type II variation applications are being submitted and/or assessed in parallel the following general principles apply:

- Each variation should comprise only the supporting data and Product Information change(s) and/or RMP change(s) proposed in the context of the specific variation;

- The assessment of the different variations will be independent, and the procedures will be kept separate regardless of the anticipated timelines of the different procedures;
- The Product Information from one variation should not include the proposed Product Information changes from a different variation, neither as highlighted nor as clean text.

In order to simplify the handling of different versions of the Product Information, submissions affecting the Product Information should be whenever possible combined in a grouped variation application, if allowed by grouping rules. Please also refer to "What groups of variations would be considered acceptable?".

Once a CHMP opinion has been adopted for a type II variation, or a Commission Decision has been granted in case an immediate EC Decision applies, the approved Product Information can be used as baseline for the Product Information of any subsequent variation(s). The consolidation can be done at the time of any procedural milestone of the subsequent variation(s) e.g. as part of the MAH's responses to a request for supplementary information, but in any case, at the latest before the adoption of the CHMP opinion.

Once included, the already approved changes related to a previous variation should appear as clean text in both the clean and highlighted versions of the Product Information for subsequent variation(s). It should be noted that only the new proposed changes related to the subsequent variation should continue to be highlighted in tracked changes during that procedure.

### ***3.13. Which post-opinion steps apply to my type II variation and when can I implement the approved changes? Rev. May 2020***

Upon adoption of the CHMP opinion, the Agency will inform the MAH within 15 days as to whether the CHMP opinion is favourable or unfavourable (including the grounds for the unfavourable outcome), as well as whether the Commission Decision granting the marketing authorisation requires any amendments.

Where the outcome of the procedure is favourable and the Commission Decision granting the Marketing Authorisation requires amendments, the Agency will inform the Commission accordingly.

#### **Re-examination**

Art. 9(2) of Regulation (EC) No 726/2004, also applies to CHMP Opinions adopted for Type II variation applications. This means that the MAH may give written notice to the Agency/CHMP that he wishes to request a re-examination within 15 days of receipt of the opinion (after which, if he does not appeal, the opinion shall be considered as final). The grounds for the re-examination request must be forwarded to the Agency within 60 days of receipt of the opinion. In case the MAH requests that the committee consults a Scientific Advisory Group (SAG) in connection with the re-examination, the applicant should inform the CHMP as soon as possible of this request.

A positive opinion may be subject to re-examination as long as the request to re-examination relates to aspects of the opinion for which there had been objections by the Committee, further to which the applicant opted to amend the application. In such case, the applicant will need to reserve the right to re-examination when submitting the amended documentation, e.g. revised product information.



The CHMP will appoint different (Co-) Rapporteurs, to co-ordinate the re-examination procedure. In case a PRAC Rapporteur is deemed necessary, he/she will be appointed. Within 60 days from the receipt of the grounds for re-examination, the CHMP will consider whether its opinion is to be revised. If considered necessary, an oral explanation can be held within this 60-day timeframe.

## **Linguistic review**

Where the product information is affected, a linguistic review of the Product Information changes will be performed. The linguistic review will start 5 days after the CHMP plenary meeting following the adoption of the CHMP opinion on the variation. The monthly linguistic review will cover all procedures affecting the annexes concluded since the latest linguistic review i.e. all variations adopted in line with the 'weekly-start' timetables as well as those following the 'monthly' timetables that have had an opinion adopted at the CHMP plenary meeting in the same month will be included. The EPAR update will also consolidate all procedures concluded since the latest EPAR update.

In the event that the only change to the Product Information concerns deletion of text or a change to numerical characters e.g. shelf life of a finished product, no post-opinion linguistic review would be necessary.

In all cases, the amended Product Information in all languages should be provided by the MAH by the date specified in the translation timetable which is provided with the CHMP opinion.

## **Decision-Making Process**

Upon receipt of a favourable CHMP opinion which requires amendments to the decision granting the marketing authorisation, the Commission shall amend the marketing authorisation to reflect the variation within 2 months, for the variations listed under Article 23(1a)(a) or within one year for the other type II variations.

Article 23(1a)(a) provides for a two month timeframe for amending the Commission decision granting the marketing authorisation for the following variations:

- Variations related to the addition of a new therapeutic indication or to the modifications of an existing one;
- Variations related to the addition of a new contra-indication;
- Variations related to a change in posology;
- Variations related to changes to the active substance of a seasonal, pre-pandemic or pandemic vaccine against human influenza;
- Other type II variations that are intended to implement changes to the decision granting the marketing authorisation due to a significant public health concern e.g. when a 'Direct Healthcare Professional Communication' (DHPC) is agreed).

All the other type II variations will follow a yearly timeframe for update of the respective Commission decision.

## Timeline for Variations *Post Opinion*

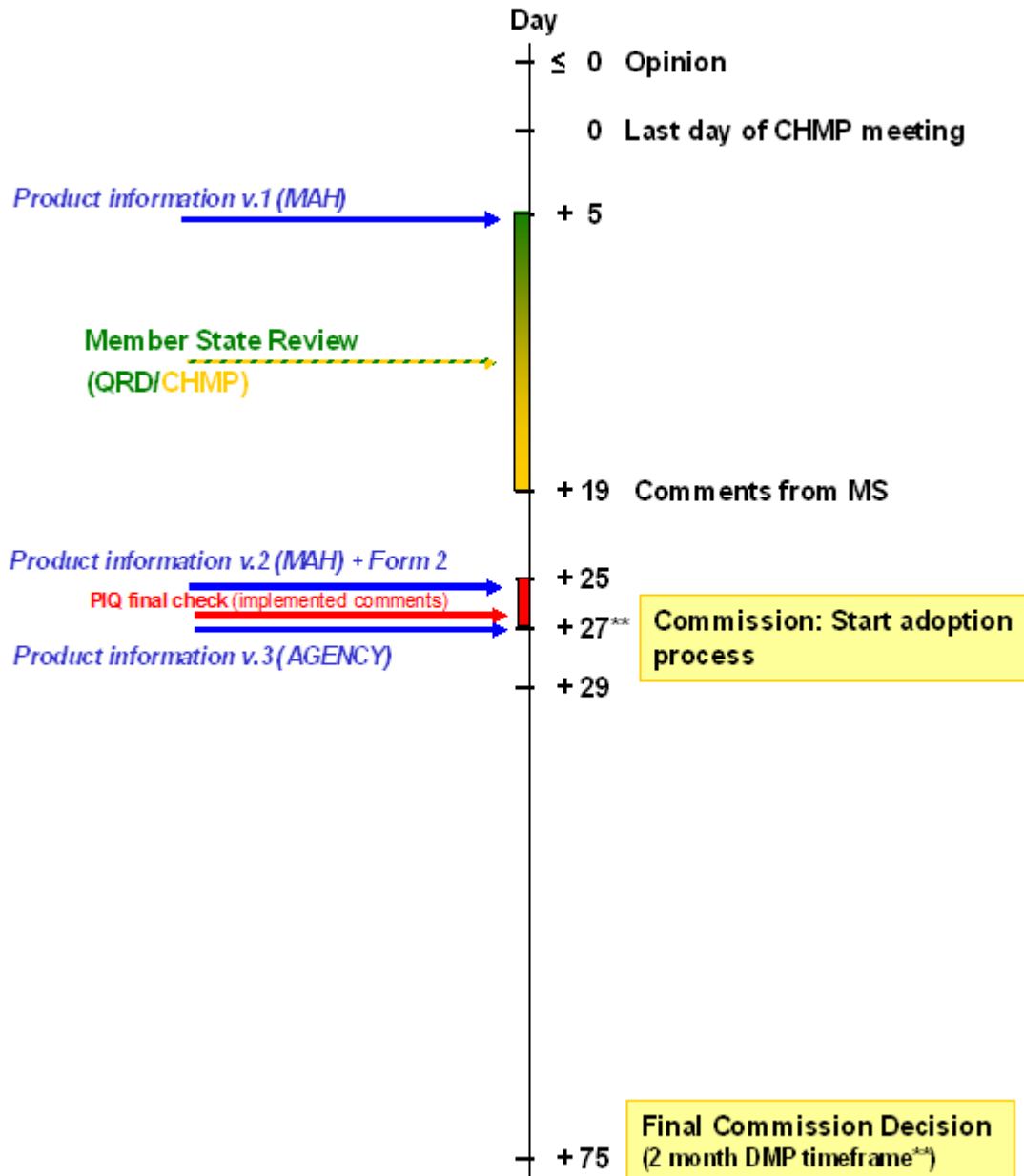

\*\* applicable only to Type II variations listed under Art. 23.1a(a) of Commission Regulation (EC) No 1234/2008

Where a group of variations to the terms of one marketing authorisation submitted as part of one variation have been approved, the Commission will update the marketing authorisation with one single decision to cover all the approved variations.

## Implementation

Type II variations listed in Article 23(1a)(a) may only be implemented once the Commission has amended the marketing authorisation and has notified the MAH accordingly. Variations related to safety issues, including urgent safety restrictions, must be implemented within a timeframe agreed by the MAH and the Agency.

Type II variations which do not require any amendment of the marketing authorisation or which follow a yearly update of the respective Commission Decision can be implemented once the MAH has been informed of the favourable outcome by the Agency. However, it is expected that where the variation includes changes to the product information, the MAH waits for the finalisation of the linguistic review process by the Agency before implementing the variation, as appropriately checked translations are considered essential for a correct implementation of the variation.

The agreed change(s) should be included in the product information annexes of any subsequent regulatory procedure.

See also question "How should parallel type II variations that affect the Product Information (PI) be handled?" above.

## Date of revision of the text

The date of revision of the text to be included in section 10 of the SmPC and corresponding section of the package leaflet for variations affecting the product information should be as follows:

- For type II variations listed in Article 23(1a)(a) this should be the date of the Commission Decision amending the marketing authorisation;
- For type II variations not listed in Article 23(1a)(a), which follow a yearly timeframe for update of the respective Commission decision, this should be the date of the adoption of the positive CHMP opinion on the variation to the terms of the marketing authorisation.

This date corresponds to the date of EC decision or CHMP opinion when that specific annex was affected.

## References

- Regulation (EC) No 726/2004
- Commission Regulation (EC) No 1234/2008 (OJ L334 of 12 December 2008)
- Commission Regulation (EU) No 712/2012 amending Regulation (EC) No 1234/2008 concerning the examination of variations to the terms of marketing authorisations for medicinal products for human use and veterinary medicinal products
- Guidelines on the details of the various categories of variations, on the operation of the procedures laid down in Chapters II, IIa, III and IV of Commission Regulation (EC) No 1234/2008 of 24 November 2008 concerning the examination of variations to the terms of marketing authorisations for medicinal products for human use and veterinary medicinal products and on the documentation to be submitted pursuant to those procedures
- Re-examination guideline
- The Linguistic Review Process of Product Information in the Centralised Procedure – Human

### **3.14. What fee do I have to pay for a type II variation? Rev. Apr 2021**

For information on the fee applicable for type II variations, please refer to the explanatory note on fees payable to the European Medicines Agency. Such fee covers all authorised strengths, pharmaceutical forms and presentations of a given medicinal product. Reduced Type II fees may apply to certain variations, as specified in the Explanatory note on fees payable to the EMA.

For Type II variations which introduce additional presentation/pack-size(s), each additional presentation/pack-size attracts separate fees (x additional presentations x separate fees). Each presentation/pack-size should therefore be declared as a separate variation on the variation application form.

Grouped Type II variations, whether consequential or not, will each attract a separate Type II fee.

The fee will become due on the date of the notification of the administrative validation to the applicant and fees will be payable within 45 calendar days of the date of the said notification. After approximately 15 days an invoice will be sent to the applicants billing address held on the Agency's file.

The invoice will contain details of the product and type of procedure involved, the fee amount, the financial information and the customer purchase order number associated with the procedures invoiced (if provided in the eSubmission delivery file). The Agency does not accept stand-alone notifications of purchase order numbers that are not associated with a dossier.

Guidance on how to pay an invoice can be found on our website.

For type II variations, if the variation is finally considered 'invalid' (i.e. an assessment process cannot be started), an administrative fee will be charged by the Agency (see also Explanatory note on fees payable to the EMA).

In case an inspection is required, please note that in addition an inspection fee will be requested (see also Pre-submission Guidance – "What is the fee for a GMP inspection?").

#### **References**

- Fees payable to the European Medicines Agency

### **3.15. Do I have to submit mock-ups and specimens? Rev. July 2013**

For information concerning submission of mock-ups and specimens in the framework of post-authorisation procedures, please refer to the document 'Checking process of mock-ups and specimens of outer/immediate labelling and package leaflet of human medicinal products in the centralised procedure, 3.4 Other post-authorisation procedures.

#### **References**

- The Checking Process of Mock-Ups and Specimens of outer/immediate labelling and package leaflets of human medicinal products in the Centralised Procedure (EMEA/305821/2006)

### **3.16. When do I have to submit revised product information? In all languages? Rev. Mar 2022**

In case the type II Variation affects the SmPC, Annex II, labelling and/or package leaflet, the revised product information Annexes must be submitted as follows:

#### *At submission*

- English language: Revised complete set of product information annexes (SmPC, Annex II, labelling and package leaflet). The application must include a clean and highlighted version of the annexes, clearly showing all proposed changes in track changes. The clean version should be provided in module 1.3.1 and the highlighted version should be provided as a word document as part of the 'working documents' outside the eCTD structure. The provision of a highlighted word version is mandatory as it facilitates the review of the application. The highlighted version should additionally be provided as a PDF document in module 1.3.1. Alternatively, proposed changes should be documented in the 'present/proposed table' of the application form or in an annex to the application form (see also question "How shall I present my Type II Variation application?" above).

#### *During the procedure*

- English language: The MAH should take into account the assessment feedback and provide revised versions of the highlighted product information as part of the responses to any requests for supplementary information during the procedure. The revised highlighted product information that is provided at these procedural milestones should be submitted in line with the requirements outlined above 'at submission'.

In addition, during the latter stages of the procedure there is often a need for fast informal exchanges between the MAH and the Rapporteur in preparation of the final CHMP opinion. During this process the MAH can provide any revised versions of the product information as well as comments/justifications by Eudralink/email in Word format. These product information versions are considered 'working documents' only and there is consequently no need to submit these updated product information proposals as part of a formal eCTD sequence (unless part of formal responses to a CHMP request for supplementary information).

See also question "How should parallel type II variations that affect the PI be handled?" above.

#### *At CHMP Opinion (Day 0)*

- English language: complete set of finally agreed product information, annexes electronically only in Word format (highlighted and clean). It is sufficient to provide the final agreed annexes by Eudralink/email at this stage (i.e. before the CHMP opinion). Furthermore, the final adopted annexes should always be provided post-opinion as part of an eCTD closing sequence.

*After CHMP Opinion (Day +5, for all variations with an opinion that month – both those on a weekly-start timetable and those on a monthly-start timetable, this is 5 days after the CHMP plenary meeting following the adoption of the CHMP opinion)*

- All EU languages (incl. NO+IS): complete set of annexes electronically only in Word format (highlighted)

*After Linguistic check (Day +25, for all variations that month – both those on a weekly-start timetable and those on a monthly-start timetable, this is 25 days after the CHMP plenary meeting following the adoption of the CHMP opinion)*

- All EU languages (incl. NO+IS): complete set of annexes electronically only in Word format (highlighted) and in PDF (clean)

## Overview

Day	Lang.*	Post-opinion linguistic review Timetable
0	EN	Electronically Word format (highlighted)
+5	All EEA	Electronically Word format (highlighted)
+25	All EEA	Electronically Word format (highlighted) PDF format (clean)

\* = complete set of Annexes i.e. Annex I, II, IIIA and IIIB submitted as one document per language

The 'complete set of Annexes' includes Annex, I, II, IIIA and IIIB i.e. all SmPC, labelling and package leaflet texts for all strengths and pharmaceutical forms of the product concerned, as well as Annex II.

The complete set of Annexes must be presented sequentially (i.e. Annex I, II, IIIA, IIIB) as one document for each official EU language. Page numbering should start with "1" (bottom, centre) on the title page of Annex I. The 'QRD Convention' published on the Agency's website should be followed. When submitting the full set of Annexes in PDF format, this should be accompanied by the completed formatting checklist which provides guidance on how to correctly prepare the PDF versions.

The electronic copy of all languages should be provided as part of the variation application on the Gateway / Web Client package. Highlighted changes should be indicated via 'Tools – Track changes'. Clean versions should have all changes 'accepted'.

Icelandic and Norwegian language versions must always be included.

At the time of the submission and throughout the procedure, the annexes provided should only reflect as highlighted text the changes introduced by the specific variation concerned. However, following adoption of the CHMP opinion it may be necessary to consolidate the adopted annexes for separate variations running in parallel, i.e. when these conclude concurrently. In that case the linguistic review will be undertaken based on the consolidated version which should reflect as highlighted text all changes for the parallel variations adopted by the CHMP at that plenary meeting and including variations adopted earlier during the month in line with the weekly-start timetable.

The section "present/proposed" in the application form should clearly list all changes proposed to the English annexes. Any minor linguistic amendments introduced for other languages should be provided as a separate document attached to the application form.

In such cases and in cases where any other ongoing procedures may affect the product information annexes, the MAH is advised to contact the Agency in advance of submission or finalisation of the procedure(s) concerned.

For those variations which affect the Annex A (e.g. introduction of a new presentation), the following principles apply:

Upon adoption of the opinion, the Agency will prepare and send to the MAH the revised English Annex A reflecting the new/amended presentation.

After CHMP Opinion (Day +5, *for variations on a weekly-start timetable, this is 5 days after the CHMP plenary meeting following the adoption of the CHMP opinion*) the MAH provides the Agency with the electronic versions of the complete set of annexes in all languages as well as the translations of the revised Annex A as a separate word document.

Please be reminded that in accordance with Union data protection requirements, no personal data should be included in the annotated product information annexes. This applies to the English version submitted at the time of opinion, the draft translation versions of the product information annexes in all the languages submitted at Day+5 as well as the final translations submitted at Day+25. Please submit annotated product information annexes in an anonymised format (i.e. names of the reviewers removed from the track-changes). If you do not wish to do so, please ensure that the individuals whose data is included consented to its sharing with EMA and its further sharing by EMA with third parties such as other marketing authorisation applicants, marketing authorisation holders and National Competent Authorities, as relevant. EMA expressly disclaims any liability or accountability for the presence of unnecessary personal data in the annotated product information annexes submitted by the marketing authorisation holder.

### **3.17. What changes will trigger new EU number(s) (additional presentation(s))? *Rev. Feb 2019***

Any changes in the number of units of medicinal product or medical device being an integral part of the medicinal product (e.g. prefilled syringes) will trigger a different EU number.

Differentiation should be made between the addition of a presentation where the two presentations will co-exist on the market on a long-term basis versus a replacement of a presentation where the new presentation will replace the previous one (it is expected that for a certain period of time, the two presentations will co-exist on the market until the stock of the previous presentation runs out).

In principle, a **replacement** of one presentation by another presentation does not trigger a new EU number, unless the number of units of medicinal product or medical device being an integral part of the medicinal product (e.g. prefilled syringes) is changed.

Examples of changes in presentations for replacement, not triggering a new EU number (this is not an exhaustive list):

- Replacement of the primary or secondary packaging,
- Change in composition (e.g. change in excipients),

In case of **addition**, as the presentations will co-exist on the market, two packs with different contents cannot be covered by the same EU number and will be considered as different presentations.

Changes in the number of any unit (not restricted to the medicinal product) or changes in the specifications of any unit (not restricted to the medicinal product) contained in the pack will trigger a new EU number.

Examples of changes that will trigger new EU numbers (this is not an exhaustive list):

- Introduction of an alternative immediate (primary) packaging made from a different material,

- Introduction of an alternative shape/dimension of a pharmaceutical form (pre-rolled sealant matrix versus flat, change in size of patch).

If you have any questions on any upcoming submission, please contact the allocated Product Lead.

**3.18. What is the procedure for assignment of new European Union sub-numbers for a type II variation concerning additional presentation(s)? *NEW Nov 2012***

At the time of the adoption of a CHMP opinion for a type II variation which includes additional presentation(s), the Agency will assign the new EU sub-numbers and include them in the revised Annex A of the medicinal product, which will be transmitted to the marketing authorisation holder together with the CHMP Opinion and respective annexes.

The marketing authorisation holder should include the newly assigned numbers in all language versions of the Annex A and in all applicable sections of the product information, which are submitted following the CHMP opinion for linguistic review.

**3.19. Will there be any publication on the outcome of my type II Variation? *Rev. Oct 2012***

The meeting highlights following each CHMP meeting give information on opinions in relation to new indications, changes to an existing indication and the addition, change or removal of a contraindication. This will include the name of the product, the name of the MAH, the indication(s). Where applicable, the CHMP gives also an update on safety information.

Please refer also to "What we publish on medicines and when?".

**References**

- EMA website – What we publish on medicines and when

**3.20. What aspects should I consider at time of submission of a type II variation if there are orphan medicinal products designated or authorised for a condition related to my proposed therapeutic indication? *Rev. May 2020***

Type II variations for a new indication, which is the same as the indication of an authorised Orphan Medicinal Product, should include relevant information in Module 1.7 of the application, based on the following considerations:

In accordance with Article 8.1 of Regulation (EC) No 141/2000, where a marketing authorisation in respect of an orphan medicinal product has been granted in all Members States, the Union and the Member States shall not, for a period of 10 years, accept another application for marketing authorisation, or grant a marketing authorisation or accept an application to extend an existing marketing authorisation, for the same therapeutic indication, in respect of a similar medicinal product.



Where a designated orphan medicinal product has been authorised for the condition which covers the proposed therapeutic indication being applied for, and a period of market exclusivity is in force, the MAH must submit a report in module 1.7.1 addressing the possible “similarity” with the authorised orphan medicinal product (even if the concerned product does not have orphan designation).

The assessment of similarity between two medicinal products takes into consideration the following criteria:

- Principal molecular structural features,
- Mechanism of action and
- Therapeutic indication.

The critical report provided in Module 1.7.1 should address the possible similarity between the proposed new medicinal product and the authorised orphan medicinal products for each of these criteria.

If significant differences exist within one or more of these criteria, the two products will not be considered as similar. These criteria are explained in the Guideline on aspects of the application of Article 8(1) and 8(3) of Regulation (EC) No 141/2000: Assessing similarity of If significant differences exist within one or more of these criteria, the two products will not be considered as similar. Commission Regulation (EC) No 847/2000 provides additional specific considerations for the definition of similar active substance applicable to chemical, biological and advanced therapy medicinal products.

If the medicinal product is deemed to be “similar” to an authorised orphan medicinal product, the MAH must furthermore provide justification in module 1.7.2 that one of the derogations laid down in Article 8.3, paragraphs (a) to (c) of the same Regulation applies, namely:

(a) the holder of the marketing authorisation for the original orphan medicinal product has given his consent to the second applicant, or

(b) the holder of the marketing authorisation for the original orphan medicinal product is unable to supply sufficient quantities of the medicinal product, or

(c) the second applicant can establish in the application that the second medicinal product, although similar to the orphan medicinal product already authorised, is safer, more effective or otherwise clinically superior.

The assessment of similarity is conducted in parallel to the evaluation of the variation application and follows the same timetable. The assessment includes the consultation of the Quality Working Party or the Biologicals Working Party for the aspects concerning the similarity of the molecular structures of the products.

Even if the variation does not concern an orphan designated product, all MAHs should still check whether their claimed new indication would potentially overlap with the indication of authorised orphan medicinal products, as listed on the Commission Website in the “Community register” of designated orphan medicinal products and include the relevant documentation in their variation application as set-out above.

## References

- Regulation (EC) No 141/2000
- Regulation (EC) No 847/2000 as amended by Regulation (EU) 2018/781

- Guideline on aspects of the application of Article 8(1) and (3) of Regulation (EC) No 141/2000: Assessing similarity of medicinal products versus authorised orphan medicinal products benefiting from market exclusivity and applying derogations from that market exclusivity
- Community Register - website of the European Commission

### **3.21. Do I need to confirm the maintenance of my orphan designation when applying for a type II variation? *Rev. Oct 2019***

If the product has been designated as orphan and the application concerns a new therapeutic indication or a modification of an existing one, in order to ensure that the Marketing Authorisation only covers indications that fulfil the orphan designation criteria foreseen in Art 3 of Regulation (EC) No 141/2000, a COMP review may be required as following:

- for a new therapeutic indication falling **within a new orphan designation**, i.e. an orphan designation other than the one(s) related to the already approved indication(s), the COMP will have to confirm the maintenance of the orphan designation before authorisation of the new indication. In this case, the sponsor should provide at the time of submission a maintenance report using the template provided on the EMA website. The maintenance report should be submitted via the IRIS Platform.
- for a new therapeutic indication falling **within an already authorised orphan designation**, the COMP will have to consider if the specific scope of the variation raises justified and serious doubts in respect to the fulfilment of the orphan designation criteria and indicate if a formal review process of the maintenance of the orphan designation is needed

To support this process, the MAH/sponsor is requested to provide at the time of submission of the variation either a justification that the variation does not raise doubts on the fulfilment of the orphan criteria or a maintenance report to justify that the orphan criteria are still met. The justification/maintenance report should be submitted via the IRIS Platform.

Further to the COMP preliminary discussion based on the sponsor's justification/ maintenance report, a formal review process of the maintenance of the orphan designation for the applied indication will be triggered if this raises justified and serious doubts on the maintenance of the orphan designation. In this case, if previously only a justification was submitted, the MAH/sponsor will be requested to provide a maintenance report. The procedure for assessment will follow the usual procedure, as described in Review of orphan designation at the time of granting/varying a marketing authorisation (SOP/H/3190).

For the purpose of defining what is a new therapeutic indication or a modification of an existing one for the COMP review for post-authorisation extensions of indications, the Guideline on the elements required to support the significant clinical benefit in comparison to existing therapies of a new therapeutic indication in order to benefit from an extended (11-year) marketing protection should be followed.

In case of doubts, the Agency encourages applicants to contact the Orphan Medicines Office in advance of a planned submission in order to clarify orphan requirements ([orphandrugs@ema.europa.eu](mailto:orphandrugs@ema.europa.eu)).

Further information can be found on the dedicated EMA Website on Orphan designation.

#### **References**

- Regulation (EC) No 141/2000

- Commission Notice on the application of Articles 3,5 and 7 of Regulation (EC) No 141/2000 on orphan medicinal products
- Post-orphan medicinal product designation procedures - Guidance for sponsors (EMA/62801/2015)
- Review of orphan designation at the time of granting/varying a marketing authorisation (SOP/H/3190)

### **3.22. Can a non-orphan therapeutic indication be added to an already authorised orphan medicinal product? *Rev. Feb 2019***

As provided for in Article 7(3) of the Regulation, it is not possible to combine within the same marketing authorisation orphan and non-orphan indications. In case you wish to extend the therapeutic indications of your orphan medicinal product to include additional non-orphan therapeutic indications, you will have to consider the following regulatory options:

- To apply for a separate application for marketing authorisation covering the therapeutic indications which are outside the scope of the Orphan Regulation
- To request the withdrawal of the orphan designation from the Community register of Orphan Medicinal Products for your medicinal product.

If the orphan designation is not yet withdrawn at time of submission, the marketing authorisation holder should undertake in their cover letter to request the withdrawal the orphan designation from the Community register not later than 2 days after the receipt of the CHMP opinion.

Based on this commitment, the Agency will validate the variation / MA extension application pertaining to a non-orphan indication. If the MAH has not requested the withdrawal of the Orphan designation within the said deadline, nor requested re-examination in accordance with Article 16(4) of Commission Regulation (EC) No. 1234/2008, the validation of application will become automatically null and void with retroactive effect.

When addressing to the EC their request of removal from the Community register of orphan designated medicinal products, the MAH should also copy the Product Lead in the correspondence.

#### **References**

- Regulation (EC) No 141/2000 on orphan medicinal products

### **3.23. Can a new indication based on less comprehensive data be added to an already authorised medicinal product? *Rev. Feb 2019***

According to Articles 14-a and 14(8) of the Regulation (EC) No 726/2004, a marketing authorisation can be granted in certain situations based on less comprehensive data than normally required, i.e. a conditional marketing authorisation or marketing authorisation under exceptional circumstances, respectively.

Granting these types of authorisation is only foreseen in the context of an application for an initial marketing authorisation. Therefore, when a "standard"/"full" marketing authorisation has been already granted, it is not possible to subsequently change this authorisation into a conditional marketing

authorisation or a marketing authorisation under exceptional circumstances. In such case, introduction of a new indication within the same marketing authorisation will have to comply with the standard data requirements. Alternatively, submission of a separate marketing authorisation (either conditional or under exceptional circumstances) may be required, taking into account also provisions concerning multiple applications.

Nevertheless, if a product already has a conditional marketing authorisation, it is possible to modify (including extend) the indication and related specific obligations, provided that any modifications that are based on less comprehensive data comply with the requirements for a conditional marketing authorisation. These requirements are set out in Article 14-a of Regulation (EC) No 726/2004 and in Commission Regulation (EC) No 507/2006 and further elaborated in the respective "CHMP guideline on conditional marketing authorisation".

Similarly, if a product has a marketing authorisation under exceptional circumstances, it is possible to modify (including extend) the indication and related specific obligations, provided that any modifications based on less comprehensive data comply with the requirements for a marketing authorisation under exceptional circumstances. These requirements are set out in Article 14 (8) of the Regulation (EC) No 726/2004 and in Part II of Annex I of Directive 2001/83/EC, and further elaborated in the respective "CHMP guideline on marketing authorisation under exceptional circumstances".

### References

- Regulation (EC) No 726/2004
- Directive 2001/83/EC
- Commission Regulation (EC) No 507/2006
- Pre-submission guidance question on "Is my medicinal product eligible for approval under exceptional circumstances?"
- Pre-submission guidance question on "Could my application qualify for a conditional marketing authorisation?"

### **3.24. Do I need to address any paediatric requirements in my type II variation application? *Rev. Apr 2012***

Regulation (EC) No 1901/2006, as amended (the 'Paediatric Regulation') lays down obligations, rewards and incentives for the development and placing on the market of medicines for use in children. The Paediatric Regulation places some obligations for the applicant when developing a new medicinal product as well as new uses of an authorised product, in order to ensure that medicines to treat children are subject to ethical research of high quality and are appropriately authorised for use in children, and to improve collection of information on the use of medicines in the various subsets of the paediatric population. The paediatric population is defined as the population between birth and the age of 18 years (meaning up to but not including 18-years).

As set out in Article 8 of the Paediatric Regulation, applications for new indication(s), new pharmaceutical form(s) and/or new route(s) of administration concerning an authorised medicinal product protected either by a supplementary protection certificate or by a patent which qualifies for the granting of such a certificate must include one of the following documents/data in order to be considered 'valid':

- The results of all studies performed and details of all information collected in compliance with an agreed Paediatric Investigation Plan (PIP).

This means that the application will have to include the PIP decision but also the results in accordance with the agreed PIP.

- A decision of the EMA on a PIP including the granting of a deferral

This means that the application will have to include the PIP decision including the deferral granted and if applicable, any completed studies.

- A decision of the EMA granting a product-specific waiver
- A decision of the EMA granting a class waiver (together with the Agency's confirmation letter of applicability if requested by the MAH)

This requirement applies irrespective of the type of application submitted for such a change(s) i.e. variation or extension (or new marketing authorisation application) and irrespective of whether the change is related to adult or paediatric use.

To define what is a 'new indication' for the purpose of the application of Article 8, please refer to the question 17 on the paediatric webpage "What is a new indication in the context of Article 8?".

Where results of PIP studies for an authorised medicinal product which do not support a paediatric indication, and the corresponding proposal for amending the SmPC and, if appropriate the Package Leaflet Product Information may be submitted as part of a variation C.I.4 as per the guideline on the details of the various categories of variations – '*Variations related to significant modifications to the SmPC*'. Applicants are requested to mention in the application form of the variation including the paediatric results and in the cover letter the following statement in the section '*Precise scope and background for change*': **'Submission of paediatric study results performed in compliance with a <completed> paediatric investigation plan which do not support a paediatric indication'**.

Applicants should include in the clinical overview a rationale supporting the proposed changes to the Product Information. In particular, if the PIP is completed and the results of all studies are available, the applicant should discuss whether the generated data support or not the intended paediatric indication(s) stated in the PIP.

Inclusion of the results of all studies performed in compliance with an agreed Paediatric Investigation Plan requirement in the Product Information is a prerequisite for benefiting from the paediatric reward (Article 36(1) of Regulation (EC) No 1901/2006).

As for all applications including results of studies performed in compliance with an agreed PIP, the applicant should also include in Module 1.10 an overview table of the PIP results, indicating in which application(s) they were/are going to be submitted, status of the application(s), as well as their location in the present application.

In addition, in accordance with Article 8, the PIP or Waiver application and the related decision should cover both the new and existing indications, routes of administration and pharmaceutical forms of the authorised medicinal product, taking into account the Global Marketing Authorisation (GMA) concept together with the notion of 'same marketing authorisation holder'. Further information can be found in the Procedural Advice document on "applications for PIPs, Waivers and Modifications" which is available on the Agency's website under 'Medicines for children'.

Those required data/documents should be included in Module 1.10 of the EU-CTD dossier.

The following types of application are exempted from the application of Article 8:

- Generics medicinal products (Art 10(1) of Directive 2001/83/EC)
- Hybrid medicinal products (Art 10(3) of Directive 2001/83/EC)
- Similar biological medicinal products (Art 10(4) of Directive 2001/83/EC)
- Medicinal products containing active substance(s) of well-established medicinal use (Art 10a of Directive 2001/83/EC)

Furthermore, when planning submission of their marketing authorisation application, the applicant has to take into account also the need for a "PIP" compliance check to be done.

Such compliance check consists of verifying that the fulfilments of the measures as mentioned in the PIP decision including the timelines for the conduct of the studies or collection of the data are fulfilled. The compliance check procedure is explained in the document Questions and answers on the procedure of paediatric investigation plan compliance verification at the European Medicines Agency. Applicants are strongly recommended to apply for the compliance check before submission of the application to not delay the validation phase.

Further details on the format, timing and content of PIP or waiver applications as well as on the compliance check can be found in the Commission guideline. In addition, deadlines for submission of PIP or Waiver applications, application templates as well as Procedural Advice documents respectively regarding applications for PIPs, Waivers and Modifications and validation of new MAA, Variation/Extension applications and compliance check with an agreed PIP are available on the Agency's website in section "Medicines for children".

## References

- Regulation (EC) No 1901/2006
- Commission Guideline on "The format and content of applications for agreement or modification of a paediatric investigation plan and request for waivers or deferrals and concerning the operation of the compliance check and on criteria for assessing significant studies"
- Procedural Advice document related to Paediatric investigation plans (PIPs), waivers and modifications
- Questions and answers on the procedure of paediatric investigation plan compliance verification at the European Medicines Agency
- EMA website, section 'Paediatric-use marketing authorisations'

### **3.25. When will I get a PIP compliance statement? *NEW Dec 2016***

The statement of compliance foreseen in Article 28(3) of Regulation (EC) No 1901/2006 is one of the prerequisites in order to be eligible for the paediatric rewards.

The following requirements have to be met for the paediatric investigation plan (PIP) compliance statement to be included in the technical dossier:

- The MAH to include in Module 1.10 of the dossier a positive outcome of full PIP compliance check by the PDCO;

- The results of all PIP measures should be included in the relevant modules of the dossier. If some results were already submitted, an overview table of the PIP results should be submitted in Module 1.10, indicating in which application(s) they were submitted, the status of the application(s) and the location of the last results submitted in the present application;
- The results of all studies conducted according to the PIP reflected in the SmPC and, as applicable, Package Leaflet.

The MAH should submit the results of PIP studies or the remaining results if some were already submitted, as well as the elements mentioned above as part of a suitable variation or group of variations.

If all the above criteria are met, a PIP compliance statement will be included in the technical dossier.

The most appropriate variation classification will have to be determined based on the assessment required. A type II variation under one of the categories C.I.4 or C.I.6.a may be appropriate, depending on the proposed amendments to the product information. In some instances, a type IB variation might be appropriate i.e. in situations when all data have already been assessed by the CHMP as part of a previous procedure and all results are already reflected in the product information.

For further details on the paediatric rewards please refer to "Questions and answers on the procedure of PIP compliance verification at EMA, and on paediatric rewards".

### **3.26. Who is my contact at the European Medicines Agency during a type II variation, including extension of indications? *Rev. Mar 2022***

The Product Lead (PL) is the primary contact for the applicant prior to submission and throughout the procedure for Type II variations related to the safety or efficacy of the medicinal product. However, if you have a procedural or regulatory pre-submission question when preparing your Type II variation application (Non-clinical/Clinical/RMP), please raise a ticket via the EMA Service Desk. Furthermore, a dedicated pool of Product Leads will be dealing with Quality Type II variations and related queries. At the time of granting an opinion to an initial MAA, you will be notified of the name of the PL who will be managing Quality related Type II variations during the lifecycle of the product.

Extension of indication follow the principles outlined for initial marketing authorisation application (MAA) evaluations (see separate Q&A).

The PL will serve as the main liaison person between the EMA product team, the Rapporteurs and the applicant. The PL, in close co-operation with the EMA product team and the rapporteurs, will ensure that the applicant is kept informed of all aspects related to the MAA evaluation of the application.

The applicant should contact the **PL** for all questions regarding the evaluation procedure, including

- Requests for scientific guidance in the pre-submission phase, such as the pre-submission meeting;
- Any type of procedural questions during the evaluation, such as availability of assessment reports and opinion documents;
- Discussion on timetables including requests for extension of clock-stops etc.
- Any question where guidance related to the evaluation procedure is needed. The PL will liaise with other EMA Product team members and redirect as appropriate.

At certain milestones during the evaluation procedure, the **PL** will contact the applicant for a direct exchange to facilitate the discussion on the scientific evaluation. These include:

- Preparation and conduct of clarification meetings (where applicant requests such meeting);
- Immediate feedback regarding scientific aspects from committee plenary discussions, where required;
- Expectations relating to the oral explanation, including topics to be addressed;
- Discussion of required post-authorisation measures;
- Late-stage revisions of the product information before adoption of the final opinion.

These interactions occur in close co-operation with the Rapporteurs. Occasionally other members from the EMA Product team may contact the applicant directly to facilitate the discussion on specific aspects (e.g. risk management).

When the applicant corresponds with other members of the EMA Product Team the PL should always be copied in the correspondence.

Please see other relevant questions and answers in the EMA pre-authorisation guidance “What is the role of the EMA product team?”, “Whom should I contact if I have a pre-submission question when preparing my Type II variation application (Non-clinical/Clinical/RMP)?” and “Who is my contact at the European Medicines Agency during a marketing authorisation application (MAA) evaluation procedure?” and more information on ‘Contacting EMA: post-authorisation’.

### **3.27. Whom should I contact if I have a pre-submission question when preparing my type II variation application (non-clinical/clinical/RMP)?** **NEW Mar 2022**

If you cannot find the answer to your question in the Q&A when preparing your application, please raise a ticket via the EMA Service Desk, using the Question option. The type of question to be selected is “Post-authorisation queries”, followed by sub-option “Variation II scopes (Non-clin/Clin/RMP)”.

The Agency aims to respond to your query within 10 working days. To help us deal with your enquiry, please provide as much information as possible including the name of the product in your correspondence.

You should submit your query once and it is important that you submit it using the applicable type of question and sub-option. If you seek advice e.g. on the classification of change(s), or the acceptability of a single variation application vs a grouped variation application, please include your proposal. Your query will be channelled internally to the relevant service(s) that will respond to you.

If you do not have an EMA Account, you may create one via the EMA Account Management portal.

Validation team: The validation of type II variations (Non-clinical/Clinical/RMP) will be handled by a dedicated team of Procedure Managers (PM). A PM will be nominated upon receipt of the variation application. You will be able to contact this PM directly if needed.



## 4. Extension of marketing authorisation

### **4.1. When will my variation application be considered a type II variation or an extension application? *Rev. Nov 2016***

Commission Regulation (EC) No 1234/2008 defines a Type II variation as a 'major variation' which may have a significant impact on the Quality, Safety or Efficacy of the medicinal product.

The Variations Regulation and the Variations Guidelines set out a list of changes to be considered as Type II variations. In addition, any other change which may have a significant impact on the quality, safety or efficacy of the medicinal product must be submitted as a Type II variation.

Certain changes to a Marketing Authorisation, however, have to be considered to fundamentally alter the terms of this authorisation and therefore cannot be granted following a variation procedure. These changes are to be submitted as 'Extensions of marketing authorisations' and are listed in Annex I of the Variations Regulation.

This Annex lists three main categories of changes requiring an extension of marketing authorisation:

1. Changes to the active substance(s)
2. Changes to strength, pharmaceutical form and route of administration
3. Other changes specific to veterinary medicinal products to be administered to food-producing animals; change or addition of target species

As the case may be, an authorisation or a modification to the existing Marketing Authorisation will have to be issued by the Commission.

The European Commission has published a guideline in order to clarify these terms pharmaceutical form and strength and to include relevant examples for such classification. (See also Guideline on the categorisation of New Applications (NA) versus Variations Applications (V), January 2002).

This guideline on categorization should be read in conjunction with the EDQM guidance on the Standard Terms, Regulation (EC) No 1234/2008 and Regulation (EC) No 1901/2006 and understood as follows:

Changes to a centralised marketing authorisation listed below should be submitted as variation(s) according to the guideline on the details of the various categories of variations to the terms of marketing authorisations:

- Addition or replacement of a presentation for a solution for injection with a different immediate container (e.g. vial, syringe, pre-filled pen, cartridge, ampoule...)
- Addition or replacement of a presentation for an eye drops solution with a different immediate container.

These changes would not fall into the scope of Article 8 of Regulation (EC) No 1901/2006 (please refer to 'What is a 'new pharmaceutical form' in the context of Article 8?')

In cases of doubt, the MAH is advised to contact the Agency in advance of the submission.

#### **References**

- Regulation (EC) No 726/2004

- Commission Regulation (EC) No 1234/2008 (OJ L334 of 12 December 2008)
- Commission Regulation (EU) No 712/2012 amending Regulation (EC) No 1234/2008 concerning the examination of variations to the terms of marketing authorisations for medicinal products for human use and veterinary medicinal products
- Guidelines on the details of the various categories of variations, on the operation of the procedures laid down in Chapters II, IIa, III and IV of Commission Regulation (EC) No 1234/2008 of 24 November 2008 concerning the examination of variations to the terms of marketing authorisations for medicinal products for human use and veterinary medicinal products and on the documentation to be submitted pursuant to those procedures
- Guideline on the categorisation of New Applications versus Variations Applications, The Rules governing Medicinal Products in the European Union, Notice to Applicants, Volume 2C
- Regulation (EC) No 1901/2006
- EDQM Guidance – ‘Standard Terms – Introduction and Guidance for use’

#### **4.2. Extension applications – will my invented name changes? *Rev. Aug 2014***

The (invented) name of the medicinal product will be the same for the “extension” as it is for the existing Marketing Authorisation of the medicinal product. The addition of a qualifier (suffix) (e.g. Invented name + qualifier) is not possible within the same marketing authorisation as this would result in a different (invented) name.

It should be clear that the complete name of the medicinal product is commonly composed of the “invented name, followed by the strength, pharmaceutical form”. The pharmaceutical form should be described by the European Pharmacopoeia’s full standard term. If the appropriate standard term does not exist, a new term may be constructed from a combination of standard terms (should this not be possible, the Competent Authority should be asked to request a new standard term from the European Directorate for Quality of Medicines (EDQM) of the Council of Europe).

#### **References**

- Commission Regulation (EC) No 1234/2008 (OJ L334 of 12 December 2008)
- “Guideline on the acceptability of names for human medicinal products processed through the centralised procedure (EMA/CHMP/287710/2014 – Rev. 6)”
- A Guideline on Summary of Product Characteristics, The Rules governing Medicinal Products in the European Union, Notice to Applicants, Volume 2C
- Standard Terms, Council of Europe

#### **4.3. Do I need to notify the Agency of my intention to submit an extension application? *Rev. Jan 2021***

Extension applications are generally supported by a substantial amount of data, especially if accompanied by an extension of indication or other changes to the authorised therapeutic indication.

As a result, the assessment timeframe is typically the same as for an initial marketing authorisation (see also question "How shall my extension applications be handled (timetable)") and significant assessment resources need to be committed for the assessment by the Rapporteur and often also from the Co-Rapporteur (see also question "Is the Co-Rapporteur involved in extension applications"). For this reason, MAHs are requested to give advance notice of their intention to submit an extension application 6 months in advance of submission. This can be achieved by means of an email to the Product Lead, BusinessPipeline@ema.europa.eu, MAAvalidations@ema.europa.eu, the Rapporteur, Co-Rapporteur and, if applicable, PRAC Rapporteur, summarising the scope of the intended application and specifying the target submission date. The information will be used for planning purposes by the Agency and the Rapporteurs' assessment teams.

#### **4.4. Is the (Co-) Rapporteur involved in Extension Applications? Rev. March 2013**

The CHMP Co-Rapporteur is normally not involved in the assessment of an Extension Application.

However, in case the Extension application would be grouped with a Type II variation for a new indication, the CHMP Co-Rapporteur would normally be involved.

Furthermore, a PRAC Rapporteur may be involved, where applicable.

#### **4.5. How shall I present my Extension Application? Rev. Feb 2022**

Extension applications should be presented as follows in accordance with the appropriate headings and numbering of the EU-CTD format:

- Cover letter (for groupings, include a short overview of the nature of the changes and indicate whether it is submitted under Article 7.2(b), i.e. it falls within one of the cases listed in Annex III of the variations regulation or it is submitted under Article 7.2(c), i.e. the grouping has been agreed with the Agency).
- The completed electronic EU application form dated and signed by the official contact person as specified in Section 2.4.3. The EMA strongly recommends the use of a single electronic application form per submission, even if the submission concerns multiple strengths/pharmaceutical forms. The MAH should carefully fill-in the following sections of the application form i.e.:
  - In case of an extension of application, section 1.3 "Yes" should be ticked;
  - The precise scope of the change needs also to be filled-in;
  - The legal basis for an extension application corresponds to the legal basis of the initial application for the medicinal product. Therefore, relevant boxes of section 1.4 should be ticked.

Note: If the extension application is grouped with other variation(s), the variation application form should be appended to this application form. See also "What type of variations can be grouped?"

- Supporting data relating to the proposed extension must be submitted. Some guidance on the appropriate additional studies required for applications under Article 10 of Directive 2001/83/EC or Extension Applications (also called "Annex I applications") are available in Annex II to Chapter 1 of the Notice to Applicants

- A full Module 1 should be provided, with justifications for absence of data/documents included in the relevant section(s) of Module 1 (e.g. in case 'user testing' is considered not necessary by the MAH, a justification should be included in section 1.3.4).
- Update/Addendum to quality summaries/non-clinical overviews and clinical overviews, if appropriate, must be submitted using the appropriate headings and numbering of the EU-CTD format. When (a) non-clinical/clinical study report(s) are submitted, even if only one, their relevant summaries should be included in Module 2.
- Module 3 of the application should only contain the relevant quality information related to the proposed extension, unless the extension is part of a group.

In order to facilitate the registration of the submission, marketing authorisation holders are required to fill in all the submission attributes through the eSubmission delivery file UI.

EMA is encouraging applicants to use the checklist to facilitate the preparation of the dossier and make the validation process more efficient. The filled-in checklist should be submitted as part of the Extension Application dossier.

In case that the changes affect the SPC, labelling and/or package leaflet, the revised product information Annexes must be submitted (see also: Extension applications - "When do I have to submit revised product information? In all languages?").

It should be noted that the responsibility for the quality of the submitted documentation lies with the MAH and is crucial to the overall process.

For queries related to the presentation of the application, please contact the Agency. Alternatively, MAHs may request a pre-submission meeting with the Agency to clarify any outstanding points.

Please also refer to the following questions which address orphan and paediatric related aspects 'Do I need to confirm the maintenance of my orphan designation when applying for an Extension Application?' and 'Do I need to address any paediatric requirements in my extension application?'

## References

- Presentation and content of the dossier - Part 1, Summary of the dossier Part 1A or Module 1: Administrative information application form, The Rules governing Medicinal Products in the European Union, Notice to Applicants, Volume 2B
- Procedures for Marketing Authorisation, The Rules governing Medicinal Products in the European Union, Notice to Applicants, Volume 2A, Chapter 1
- Electronic Variation application form

## **4.6. What aspects should I consider at time of submission of an extension application if there are orphan medicinal products designated or authorised for a condition related to my proposed therapeutic indication? *Rev. May 2020***

Article 8(1) of the Regulation (EC) No 141/2000 ("Orphan Regulation") prevents the Agency and the Member States from accepting, for a period of 10 years, another application for a marketing authorisation, or granting a marketing authorisation or accepting an application to extend an existing marketing authorisation, for the same therapeutic indication, in respect of a similar medicinal product.

Therefore, if your application concerns an extension of a marketing authorisation, as defined in Annex I of the Regulation (EC) No 1234/2008 ("Variations Regulation"), e.g. a new pharmaceutical form or route of administration, you will have to indicate in the respective application form if any medicinal product has been designated as an orphan medicinal product for a condition relating to the therapeutic indication proposed in your application.

In advance of submission of your application for an extension of your marketing authorisation, irrespective of whether your medicinal product has been designated as orphan or not, you are advised to check the Community register of orphan medicinal products, for information on medicinal products designated as orphan.

If any of the designated orphan medicinal products has been granted a marketing authorisation in the Union, and a period of market exclusivity is in force, you will have to provide in Module 1.7.1 a similarity report addressing the possible similarity between your medicinal products and the orphan medicinal product(s) which have received a marketing authorisation.

The assessment of similarity between two medicinal products takes into consideration the following criteria:

- Principal molecular structural features,
- Mechanism of action and
- Therapeutic indication.

The critical report provided in Module 1.7.1 should address the possible similarity between the proposed new medicinal product and the authorised orphan medicinal products for each of these criteria.

If significant differences exist within one or more of these criteria, the two products will not be considered as similar. These criteria are explained in the Guideline on aspects of the application of Article 8(1) and 8(3) of Regulation (EC) No 141/2000: Assessing similarity of If significant differences exist within one or more of these criteria, the two products will not be considered as similar. Commission Regulation (EC) No 847/2000 provides additional specific considerations for the definition of similar active substance applicable to chemical, biological and advanced therapy medicinal products.

If your product is considered to be similar to any authorised orphan medicinal product, you will have to provide in Module 1.7.2 justification that one of the following derogations, laid down in Article 8(3) of the Orphan Regulation applies, i.e.:

(a) the holder of the marketing authorisation for the orphan medicinal product has given his consent for submission of your application, in which case a signed letter from the MAH of the orphan medicinal product should be provided confirming the consent for submission of an application for marketing authorisation;

(b) the holder of the marketing authorisation for the orphan medicinal product is unable to supply sufficient quantities of the medicinal product, in which case the applicant should provide a report including details of the supply shortage and justify that patients' needs in the orphan indication are not being met;

(c) the applicant can establish that their product, although similar to the orphan medicinal product already authorised, is more effective, safer or otherwise clinically superior, in which case a critical report justifying clinical superiority to the authorised product must be provided.

The assessment of similarity is conducted in parallel to the evaluation of the extension application and follows the same timetable. The assessment includes the consultation of the Quality Working Party or the Biologicals Working Party for the aspects concerning the similarity of the molecular structures of the products.

Please note that if the Agency identifies a possible similarity issue not addressed by the applicant before validation, the applicant will be asked to complete the application with information on similarity and, if applicable, on one of the derogations. Validation of the application will only proceed once the applicant has submitted either a report justifying the lack of similarity or information justifying one of the derogations in Article 8(3).

As considerable time may elapse between validation of an application and adoption of an opinion, if applicants become aware of medicinal products which have been authorised as orphans for a condition related to the therapeutic indication proposed in their application, this information should be communicated promptly to the Agency in order to arrange for the submission of updated application form and modules 1.7.1 and 1.7.2, as applicable.

In any case, the Agency will check at certain milestones of the procedure, i.e. adoption of list of questions, request for supplementary information and prior to adoption of a CHMP opinion whether new orphan medicinal products have been authorised for the same condition.

## References

- Regulation (EC) No 141/2000 on orphan medicinal products
- Regulation (EC) No 847/2000 as amended by Regulation (EU) 2018/781
- Regulation (EC) No 1234/2008
- Community register of orphan medicinal products
- Guideline on aspects of the application of Article 8(1) and 8(3) of Regulation (EC) No 141/2000: Assessing similarity of medicinal products versus authorised orphan medicinal products benefiting from market exclusivity and applying derogations from that market exclusivity

### **4.7. Do I need to confirm the maintenance of my orphan designation when applying for an extension application? *Rev. Oct 2019***

If the product has been designated as orphan and the extension application also includes a new therapeutic indication or a modification of an existing one, in order to ensure that the Marketing Authorisation only covers indications that fulfil the orphan designation criteria foreseen in Art 3 of Regulation (EC) No 141/2000, a COMP review may be required as following:

- for a new therapeutic indication falling within a new orphan designation, i.e. an orphan designation other than the one(s) related to the already approved indication(s), the COMP will have to confirm the maintenance of the orphan designation before authorisation of the new indication. In this case, the sponsor should provide at the time of submission a maintenance report using the template provided on the EMA website. The maintenance report should be submitted via the IRIS Platform.
- for a new therapeutic indication falling within an already authorised orphan designation, the COMP will have to consider if the specific scope of the application raises justified and serious doubts in

respect to the fulfilment of the orphan designation criteria and indicate if a formal review process of the maintenance of the orphan designation is needed

To support this process, the MAH/sponsor is requested to provide at the time of submission of the application either a justification that the application does not raise doubts on the fulfilment of the orphan criteria or a maintenance report to justify that the orphan criteria are still met. The justification/ maintenance report should be submitted via the IRIS Platform.

Further to the COMP preliminary discussion based on the sponsor's justification/ maintenance report, a formal review process of the maintenance of the orphan designation for the applied indication will be triggered if this raises justified and serious doubts on the maintenance of the orphan designation. In this case, if previously only a justification was submitted, the MAH/sponsor will be requested to provide a maintenance report. The procedure for assessment will follow the usual procedure, as described in Review of orphan designation at the time of granting/varying a marketing authorisation (SOP/H/3190).

For the purpose of defining what is a new therapeutic indication or a modification of an existing one for the COMP review for post-authorisation extensions of indications, the Guideline on the elements required to support the significant clinical benefit in comparison to existing therapies of a new therapeutic indication in order to benefit from an extended (11-year) marketing protection should be followed.

In case of doubts, the Agency encourages applicants to contact the Orphan Medicines Office in advance of a planned submission in order to clarify orphan requirements (orphandrugs@ema.europa.eu).

Further information can be found on the dedicated EMA Website on Orphan designation.

#### **References**

- Regulation (EC) No 141/2000
- Commission Notice on the application of Articles 3,5 and 7 of Regulation (EC) No 141/2000 on orphan medicinal products
- Post-orphan medicinal product designation procedures - Guidance for sponsors (EMA/62801/2015)
- Review of orphan designation at the time of granting/varying a marketing authorisation (SOP/H/3190)

#### **4.8. Can a non-orphan therapeutic indication be added to an already authorised orphan medicinal product? *NEW Mar 2016***

Please refer to question "Can a non-orphan therapeutic indication be added to an already authorised orphan medicinal product?" in the questions and answer of Type II variations.

#### **4.9. Can a new indication based on less comprehensive data be added to an already authorised medicinal product? *NEW Nov 2016***

Please refer to question "Can a new indication based on less comprehensive data be added to an already authorised medicinal product?" in the questions and answer on Type II variations.

#### **4.10. Can I group the submission of Extensions with other types of variations? *Rev. Oct 2013***

Marketing authorisation holders may choose to group the submission of one or more extensions together with one or more other variations for the same product into one application, provided that this corresponds to one of the cases listed in Annex III of the Variations Regulation or when this has been agreed upfront with the Agency.

It is possible for a marketing authorisation holder to group extensions with other variation(s) submission (e.g. Type II, Type IB or IA variations), where applicable. Such grouped submissions will follow the review procedure of the highest variation in the group. Please also refer to "What types of variations can be grouped?".

However, no worksharing of extension applications is foreseen in the variations regulation.

#### **References**

- Commission Regulation (EC) No 1234/2008 (OJ L334 of 12 December 2008)
- Commission Regulation (EU) No 712/2012 amending Regulation (EC) No 1234/2008 concerning the examination of variations to the terms of marketing authorisations for medicinal products for human use and veterinary medicinal products
- Guidelines on the details of the various categories of variations, on the operation of the procedures laid down in Chapters II, IIa, III and IV of Commission Regulation (EC) No 1234/2008 of 24 November 2008 concerning the examination of variations to the terms of marketing authorisations for medicinal products for human use and veterinary medicinal products and on the documentation to be submitted pursuant to those procedures

#### **4.11. How, when and to whom shall I submit my Extension Application? *Rev. Feb 2019***

Information is available on 'Submitting a post-authorisation application'.

The MAH shall submit the Extension application in accordance with the recommended submission dates published on the Agency website (see "submission deadlines and full procedural timetables").

#### **4.12. How shall my Extension Application be handled (timetable)? *Rev. May 2020***

The MAH shall submit the Extension application(s) in accordance with the recommended submission dates published on the Agency's website.

The submission deadlines and full procedural detailed timetables are published as a generic calendar on the Agency's website (see: "submission deadlines and full procedural timetables"). The published timetables identify the submission, start and finish dates of the procedures as well as other interim dates/milestones that occur during the procedure.

The Agency shall ensure that the opinion of the CHMP is given within 210 days (less any clock-stops for the applicant to provide answers to question from the CHMP) in accordance with the following



standard timetable. A positive opinion can be adopted either at Day 120 or Day 180 should no questions remain at these milestones.

DAY	ACTION
1	Start of the procedure
80	CHMP members and Agency receive the Assessment Report from Rapporteur. The Agency sends the Assessment Report to the MAH making it clear that it only sets out the Rapporteur's preliminary conclusions. The report in no way binds the CHMP and is sent to the MAH for information only.
100	Rapporteur, other CHMP members and Agency receive comments from Members of the CHMP.
115	CHMP members and Agency receive a draft list of questions (including draft overall conclusions and draft overview of the scientific data) from Rapporteur.
120	CHMP adopts the list of questions as well as the overall conclusions and overview of the scientific data to be sent to the MAH by the Agency.
Clock stop.	
121*	Submission of the responses and restart of the clock.

\*Target dates for the submission of the responses are published on the Agency's Website

After receipt of the responses, the CHMP will adopt a timetable for the evaluation of the responses. In general the following timetable will apply:

DAY	ACTION
150	CHMP members and Agency receive the Response Assessment Report from Rapporteur. The Agency sends the Assessment Report to the MAH making it clear that it only sets out the Rapporteur's preliminary conclusions. The report in no way binds the CHMP and is sent to the MAH for information only.
170	Comments from CHMP Members to Rapporteur.
180	CHMP discussion and decision on the need for an oral explanation by the MAH. If oral explanation is needed, the clock is stopped to allow the MAH to prepare the oral explanation.
181	Restart of the clock and oral explanation.
185	Final draft of English SmPC, labelling and package leaflet sent by MAH to the Rapporteur, Agency and other CHMP members.
By 210	Adoption of CHMP Opinion + CHMP Assessment Report.

In cases where the PRAC is involved in an extension application, e.g. when an RMP is submitted within the extension, the following timetables with PRAC milestones will apply:

DAY	ACTION
1	Start of the procedure
80	CHMP members and Agency receive the Assessment Report from Rapporteur. The Agency sends the Assessment Report to the MAH making it clear that it only sets out the Rapporteur's preliminary conclusions. The report in no way binds the CHMP and is sent to the MAH for information only.
87	PRAC Rapporteur circulates the RMP assessment report and proposed RMP LoQ
100	Rapporteur, other CHMP members and Agency receive comments from Members of the CHMP.
101-104	PRAC adopts PRAC RMP Assessment Overview and Advice for D120 LOQ
115	CHMP members and Agency receive a draft list of questions (including draft overall conclusions and draft overview of the scientific data) from Rapporteur.
120	CHMP adopts the list of questions as well as the overall conclusions and overview of the scientific data to be sent to the MAH by the Agency.
Clock stop.	
121*	Submission of the responses and restart of the clock.

\*Target dates for the submission of the responses are published on the Agency's Website

After receipt of the responses, the CHMP will adopt a timetable for the evaluation of the responses. In general, the following timetable will apply:

DAY	ACTION
150	CHMP members and Agency receive the Response Assessment Report from Rapporteur. The Agency sends the Assessment Report to the MAH making it clear that it only sets out the Rapporteur's preliminary conclusions. The report in no way binds the CHMP and is sent to the MAH for information only.
167	PRAC adopts PRAC RMP Assessment Overview and Advice for D180 LoOI
170	Comments from CHMP Members to Rapporteur.
180	CHMP discussion and decision on the need for an oral explanation by the MAH. If oral explanation is needed, the clock is stopped to allow the MAH to prepare the oral explanation.
181	Restart of the clock and oral explanation.
181 to 210	Final draft of English SmPC, labelling and package leaflet sent by MAH to the Rapporteur, Agency and other CHMP members.
197	PRAC adopts the final PRAC RMP Assessment Overview and Advice
By 210	Adoption of CHMP Opinion + CHMP Assessment Report.

## Re-examination

Art. 9(2) of Regulation (EC) No 726/2004, also applies to CHMP Opinions adopted for Extension applications. This means that the MAH may give written notice to the EMA/CHMP that he wishes to request a re-examination within 15 days of receipt of the opinion (after which, if he does not appeal, the opinion shall be considered as final). The grounds for the re-examination request must be forwarded to the Agency within 60 days of receipt of the opinion. In case the MAH requests that the committee consults a Scientific Advisory Group (SAG) in connection with the re-examination, the applicant should inform the CHMP as soon as possible of this request.

A positive opinion may be subject to re-examination as long as the request to re-examination relates to aspects of the opinion for which there had been objections by the Committee, further to which the applicant opted to amend the application. In such case, the applicant will need to reserve the right to re-examination when submitting the amended documentation, e.g. revised product information.

The CHMP will appoint different CHMP (Co-) Rapporteurs, to co-ordinate the appeal procedure. In case a PRAC Rapporteur is deemed necessary, he/she will be appointed. Within 60 days from the receipt of the grounds for appeal, the CHMP will consider whether its opinion is to be revised. If considered necessary, an oral explanation can be held within this 60-day timeframe.

## Decision-Making Process

Upon receipt of the final CHMP opinion, the commission shall, where necessary, amend the marketing authorisation to reflect the extension within the timeframes set-out in article 9(1) of Regulation (EC) No 726/2004 (i.e. within 67 days after adoption of the CHMP opinion). Detailed practical guidance on the post-opinion phase, including the linguistic checking of the amended product information annexes, is available on the Agency's website.

The outcome of the evaluation of an extension application in the centralised procedure will result in an extension or a modification of the initial marketing authorisation. Extensions may only be implemented once the Commission has amended the decision granting the marketing authorisation and has notified the holder accordingly.

## References

- Regulation (EC) No 726/2004
- Commission Regulation (EC) No 1234/2008 (OJ L334 of 12 December 2008)
- Commission Regulation (EU) No 712/2012 amending Regulation (EC) No 1234/2008 concerning the examination of variations to the terms of marketing authorisations for medicinal products for human use and veterinary medicinal products

### **4.13. What fee do I have to pay for an Extension Application? *Rev. Apr 2021***

For information on the fee applicable for an extension application for each new strength, new pharmaceutical form or new route of administration, please refer to the explanatory note on fees payable to the European Medicines Agency. Reduced extension fees apply to:

- All quality extensions for which no new clinical data are submitted by the marketing authorisation holder.

If variations are grouped to this extension application, whether consequential or not, they will each attract a separate relevant fee.

The fee will become due on the date of the notification of the administrative validation to the applicant and fees will be payable within 45 calendar days of the date of the said notification. After approximately 15 days an invoice will be sent to the applicants billing address held on the Agency's file.

The invoice will contain details of the product and type of procedure involved, the fee amount, the financial information and customer purchase order number associated with the procedures invoiced (if provided in the eSubmission delivery file). The Agency does not accept stand-alone notifications of purchase order numbers that are not associated with a dossier.

Guidance on how to pay an invoice can be found on our website.

Where an extension application is considered 'invalid' (i.e. an assessment process cannot be started), an administrative fee will be charged by the Agency (see also Explanatory note on fees payable to the EMA).

#### **References**

- Fees payable to the European Medicines Agency
- Guideline on the categorisation of New Applications versus Variations Applications, The Rules governing Medicinal Products in the European Union, Notice to Applicants, Volume 2C

#### **4.14. Do I have to submit mock-ups and specimens? *Rev. July 2013***

For information concerning submission of mock-ups and specimens in the framework of extension applications, please refer to the document 'Checking process of mock-ups and specimens of outer/immediate labelling and package leaflet of human medicinal products in the centralised procedure, 3.1 New marketing authorisation applications and extensions applications.

#### **References**

- The Checking Process of Mock-Ups and Specimens of outer/immediate labelling and package leaflets of human medicinal products in the Centralised Procedure (EMEA/305821/2006)

#### **4.15. When do I have to submit revised product information? In all languages? *Rev. Mar 2022***

In case the Extension Application requires changes to the product information (e.g. new strength or pharmaceutical form), the same requirements as for a New Application apply:

- At submission and during assessment, only the English language clean and highlighted version of the Product Information both within the eCTD sequence (as pdf document) and in word format (working document) is submitted and reviewed. As an alternative to the submission of a highlighted Product Information as pdf within the eCTD sequence, proposed changes can be

documented in the 'present/proposed table' of the application form or in an annex to the application form.

In addition, during the later stages of the procedure there is often a need for fast informal exchanges between the MAH and the Rapporteur in preparation of the final CHMP opinion. During this process the MAH can provide any revised versions of the Product Information as well as comments/justifications by Eudralink/email in Word format. These product information versions are considered 'working documents' only and there is consequently no need to submit these updated Product Information proposals as part of a formal eCTD sequence (unless part of formal responses to a CHMP List of Questions/Outstanding Issues).

- Translations of the agreed SPC, Annex II, labelling and package leaflet text in all languages are to be provided after adoption of the CHMP opinion. Icelandic and Norwegian language versions of the extension Annexes must be included.

More details on the translation requirements and on the linguistic review process, are available on the Agency's Website: The linguistic review process of product information in the centralised procedure - Human (EMA/5542/02).

MAHs are reminded that, during assessment, the English product information Annexes should only include those SPC, Labelling and/or PL relevant to the Extension Application concerned.

After adoption of the CHMP Opinion, however, a complete set of Annexes for the medicinal product concerned must be submitted. A 'complete set of Annexes' includes Annex, I, II, IIIA and IIIB i.e. all SPC, labelling and PL texts for all strengths and pharmaceutical forms of the product concerned, as well as Annex II.

The complete set of Annexes must be presented sequentially (i.e. Annex I, II, IIIA, IIIB) as one document for each official EU language. Page numbering should start with "1" (bottom, centre) on the title page of Annex I. The electronic copy of all languages should be provided on the Gateway / Web Client package as part of the extension application.

The 'QRD Convention' published on the Agency's website should be followed. When submitting the full set of Annexes in PDF format, this should be accompanied by the completed formatting checklist which provides guidance on how to correctly prepare the PDF versions.

The Annexes provided should only reflect the changes introduced by the Extension application concerned. However, in exceptional cases where MAHs take the opportunity to introduce minor linguistic amendments in the texts (e.g. further to a specimen check) this should be clearly mentioned in the cover letter. Alternatively, a listing of proposed changes may be provided as a separate document attached to the cover letter. Any changes not listed, will not be considered as part of the extension application.

In cases where any other ongoing procedures may impact on the product information of the Extension Application, the MAH is advised to contact the Agency in advance of submission or finalisation of the procedure(s) concerned.

For extension applications which affect the Annex A (e.g. introduction of a new strength), the following principles apply:

Upon adoption of the Opinion, the Agency will prepare and send to the MAH the revised English Annex A. After CHMP Opinion (Day 215), the MAH provides the Agency with the electronic versions of the

complete set of Annexes in all languages as well as the translations of the revised Annex A as a separate word document.

Please be reminded that in accordance with Union data protection requirements, no personal data should be included in the annotated product information annexes. This applies to the English version submitted at the time of opinion, the draft translation versions of the product information annexes in all the languages submitted at D215 as well as the final translations submitted at 235. Please submit annotated product information annexes in an anonymised format (i.e. names of the reviewers removed from the track-changes). If you do not wish to do so, please ensure that the individuals whose data is included consented to its sharing with EMA and its further sharing by EMA with third parties such as other marketing authorisation applicants, marketing authorisation holders and National Competent Authorities, as relevant. EMA expressly disclaims any liability or accountability for the presence of unnecessary personal data in the annotated product information annexes submitted by the marketing authorisation holder.

#### **References**

- The linguistic review process of product information in the Centralised Procedure (EMA/5542/02)

#### **4.16. What is the procedure for assignment of new European Union sub-numbers for an extension including additional presentation(s)? *New Nov 2012***

At the time of the adoption of a CHMP opinion for an extension application which includes additional presentation(s), the Agency will assign the new EU sub-numbers and include them in the revised Annex A of the medicinal product, which will be transmitted to the Marketing Authorisation Holder together with the CHMP Opinion and respective annexes.

The Marketing Authorisation Holder should include the newly assigned numbers in all language versions of the Annex A and in all applicable sections of the product information, which are submitted following the CHMP opinion for linguistic review.

#### **4.17. Will there be any publication on the outcome of my Extension application? *Rev. Oct 2012***

Information on opinions of extension application is not given in the meeting highlights following each CHMP meeting, unless they are grouped with a Type II variation in relation to new indications, changes to an existing indication, addition, change or removal of a contraindication.

#### **References**

- CHMP Press Release
- CHMP Monthly Report

#### **4.18. Do I need to address any paediatric requirements in my extension application? Rev. Apr 2012**

Regulation (EC) No 1901/2006, as amended (the 'Paediatric Regulation') lays down obligations, rewards and incentives for the development and placing on the market of medicines for use in children. The Paediatric Regulation places some obligations for the applicant when developing a new medicinal product as well as new uses of an authorised product, in order to ensure that medicines to treat children are subject to ethical research of high quality and are appropriately authorised for use in children, and to improve collection of information on the use of medicines in the various subsets of the paediatric population. The paediatric population is defined as the population between birth and the age of 18 years (meaning up to but not including 18-years).

As set out in Article 8 of the Paediatric Regulation, applications submitted for new indication(s), new pharmaceutical form(s) and/or new route(s) of administration concerning an authorised medicinal product protected either by a supplementary protection certificate or by a patent which qualifies for the granting of such a certificate must include one of the following documents/data in order to be considered 'valid':

- The results of all studies performed and details of all information collected in compliance with an agreed Paediatric Investigation Plan (PIP).  
This means that the application will have to include the PIP decision but also the results in accordance with the agreed PIP.
- A decision of the Agency on a PIP including the granting of a deferral  
This means that the application will have to include the PIP decision including the deferral granted and if applicable, any completed studies.
- A decision of the Agency granting a product-specific waiver
- A decision of the Agency granting a class waiver (together with the Agency's confirmation letter if requested by the MAH)

This requirement applies irrespective of the type of application submitted for such a change(s) i.e. variation or extension (or new marketing authorisation application) and irrespective of whether the change is related to adult or paediatric use.

To define what is a 'new indication' for the purpose of the application of Article 8, please refer to the question 17 on the paediatric webpage: 'What is a new indication in the context of Article 8?'

Where results of PIP studies are submitted and do not support a paediatric indication, applicants are requested to mention in the cover letter the following statement: 'Submission of paediatric study results performed in compliance with a <completed> paediatric investigation plan which do not support a paediatric indication'.

Applicants should include in the clinical overview a rationale supporting the proposed changes to the Product Information. In particular, if the PIP is completed and the results of all studies are available, the applicant should discuss whether the generated data support or not the intended paediatric indication(s) stated in the PIP.

Inclusion of the results of all studies performed in compliance with an agreed Paediatric Investigation Plan in the Product Information is a prerequisite for benefiting from the paediatric reward (Article 36(1) of Regulation (EC) No 1901/2006).

In addition, in accordance with Article 8, the PIP or Waiver application and the related decision should cover both the new and existing indications, routes of administration and pharmaceutical forms of the authorised medicinal product, taking into account the Global Marketing Authorisation (GMA) concept together with the notion of 'same marketing authorisation holder'. Further information can be found in the Procedural Advice document on applications for PIPs, Waivers and Modifications which is available on the Agency's website under 'Medicines for children'.

Those required data/documents should be included in Module 1.10 of the EU-CTD dossier. As for all applications including results of studies performed in compliance with an agreed PIP, the applicant should also include in Module 1.10 an overview table of the PIP results, indicating in which application(s) they were/are going to be submitted, status of the application(s), as well as their location in the present application.

The following types of application are exempted from the application of Article 8:

- Generics medicinal products (Art 10(1) of Directive 2001/83/EC)
- Hybrid medicinal products (Art 10(3) of Directive 2001/83/EC)
- Similar biological medicinal products (Art 10(4) of Directive 2001/83/EC)
- Medicinal products containing active substance(s) of well-established medicinal use (Art 10a of Directive 2001/83/EC)

Furthermore, when planning submission of their marketing authorisation application, the applicant has to take into account also the need for a "PIP" compliance check to be done.

Such compliance check consists of verifying that the fulfilments of the measures as mentioned in the PIP decision including the timelines for the conduct of the studies or collection of the data are fulfilled. The compliance check procedure is explained in the document "Questions and answers on the procedure of paediatric investigation plan compliance verification at the European Medicines Agency". Applicants are strongly recommended to apply for the compliance check before submission of the marketing authorisation application to not delay the validation phase.

Further details on the format, timing and content of PIP or waiver applications as well as on the compliance check can be found in the Commission guideline. In addition, deadlines for submission of PIP or Waiver applications, application templates as well as Procedural Advice documents respectively regarding applications for PIPs, Waivers and Modifications and validation of new MAA, Variation/Extension applications and compliance check with an agreed PIP are available on the Agency's website in section "Medicines for children".

## References

- Regulation (EC) No 1901/2006
- Commission Guideline on "The format and content of applications for agreement or modification of a paediatric investigation plan and request for waivers or deferrals and concerning the operation of the compliance check and on criteria for assessing significant studies"
- Procedural Advice document related to Paediatric investigation plans (PIPs), waivers and modifications
- Questions and answers on the procedure of paediatric investigation plan compliance verification at the European Medicines Agency



- EMA website, section 'Paediatric-use marketing authorisations'

**4.19. Who should I contact if I have a question when preparing my application and during the procedure? *Rev. Feb 2019***

If you cannot find the answer to your question in the Q&A when preparing your application or during the procedure, please contact the Product Lead responsible for your product.

## 5. Grouping of variations

### 5.1. What types of variations can be grouped? *Rev. Oct 2013*

Article 7.2(a) of the Variations Regulation sets out the possibility for a marketing authorisation holder to group several Type IA/ IA<sub>IN</sub> variations under a single notification to the same relevant authority:

- **Several** Type IA or IAIN affecting **one** medicinal product.

This means for instance that a Type IA variation which is normally not subject to immediate notification can be included in the submission of a Type IA<sub>IN</sub> variation.

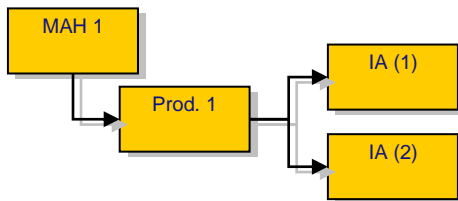

- **one** Type IA or IAIN affecting **several** medicinal products from the same MAH.

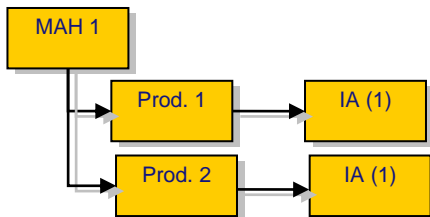

- **several** Type IA and/or IAIN affecting **several** medicinal products from the same MAH, provided that those variations are the same for all medicinal products and are submitted to the same relevant authority.

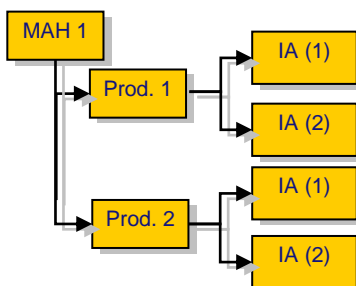

Applicants belonging to the same mother company or group of companies and applicants having concluded agreements or exercising concerted practices concerning the placing on the market of the medicinal product(s) concerned, have to be taken as “the same marketing authorisation holder”.<sup>2</sup>

All medicinal products concerned should be authorised through the centralised procedure.

<sup>2</sup> See Commission Communication 98/C 229/03 OJ C 229, 22.7.1998, p. 4.

Articles 7.2(b) and 7.2(c) of the Variations Regulation set-out the possibility for a marketing authorisation holder to group several types of variations affecting **one medicinal product**, under a single notification/application.

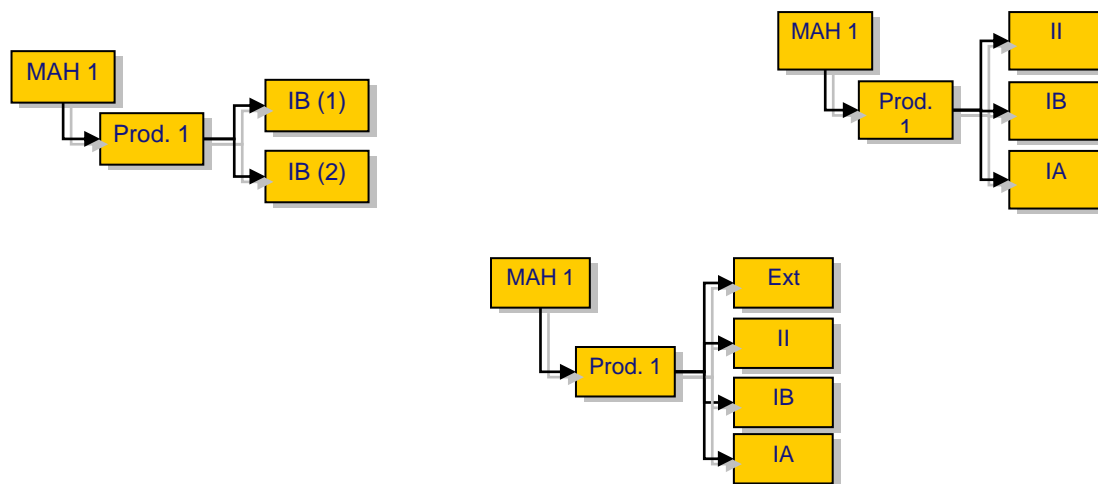

Article 7.2(b) applies for groupings that are listed in Annex III of the Regulation whilst article 7.2(c) applies for groupings of variations which are not listed in Annex III, but which have been agreed with the Agency.

In the case of groupings under Article 7.2(c) it is recommended that the grouping is agreed between the holder and the Agency at least 2 months before submission.

Where the same Type IB or Type II variation, or group of variation(s) affect several medicinal products from the same MAH, the MAH may choose to submit these variations as one application for 'worksharing'. Please also refer to "What is worksharing and what types of variations can be subject to worksharing?"

## References

- Regulation (EC) No 726/2004
- Commission Regulation (EC) No 1234/2008 (OJ L334 of 12 December 2008)
- Commission Regulation (EU) No 712/2012 amending Regulation (EC) No 1234/2008 concerning the examination of variations to the terms of marketing authorisations for medicinal products for human use and veterinary medicinal products
- Guidelines on the details of the various categories of variations, on the operation of the procedures laid down in Chapters II, IIa, III and IV of Commission Regulation (EC) No 1234/2008 of 24 November 2008 concerning the examination of variations to the terms of marketing authorisations for medicinal products for human use and veterinary medicinal products and on the documentation to be submitted pursuant to those procedures

## **5.2. What groups of variations would be considered acceptable? Rev. Dec 2019**

There are no conditions for the grouping of type IA/ IA<sub>IN</sub> variations concerning one medicinal product.

It must be noted however, that when submitting type IA/ IA<sub>IN</sub> variations as part of a group, the legal deadlines for submission of each variation should be respected i.e. a type IA<sub>IN</sub> should always be submitted immediately, whether or not it is grouped with other variations, and any type IA variation should always be submitted within 12 months following its implementation.

When grouping one or more type IA/ IA<sub>IN</sub> variations affecting several centrally authorised medicinal products from the same MAH, the variation or group of variations must be the same for all medicinal products concerned.

Grouping of other types of variations is only acceptable when they fall within one of the cases listed in Annex III of the Regulation, or, if they do not fall within one of those cases, when the grouping of the variations has been agreed between the Agency and the MAH before submission.

MAHs are advised to inform the Agency at least 2 months in advance of the submission of a group of variations which are not listed in Annex III of the Regulation, together with a justification as to why the holder believes that the proposed group should be acceptable.

When reviewing MAH proposals for grouping of variations, the Agency will consider the following general principles:

- Changes should be consequential and/or related i.e. **meaningful to be reviewed simultaneously**, although a proposal to submit a grouped application cannot be based on convenience alone (e.g. the following cases would not in principle be acceptable: both variations result in changes to the PI or all variations affect the RMP). However, applicants are generally encouraged to group related variations whenever possible e.g. variations affecting clinical safety, variations including only non-clinical studies or variations including only drug-drug interaction studies. In these cases, the scopes are related and it would be meaningful for the respective variations to be reviewed simultaneously.
- Quality, Non-clinical and Clinical changes can normally not be grouped unless exceptionally justified.
- CHMP-led and PRAC-led type II variations can normally not be grouped unless exceptionally justified (i.e. the scopes are closely interlinked).
- Quality variations to the active substance can normally not be grouped with finished product variations, unless justified.
- Grouping should not delay the submission and implementation of updates to the safety information for the medicinal product.
- Studies undertaken in different patient populations should in general not be grouped unless the applicant can justify why it would be beneficial to assess them together (e.g. supportive of overall clinical safety).

Table 1 presents some examples of acceptable groups of variations listed in Annex III of the Regulation, with further clarification on how such groups will be considered in practice.

Table 2 presents some examples of other groups of variations, which the Agency would or not in principle consider acceptable.

These tables will be reviewed and updated regularly, in view of accumulated experience.

**Table 1. Grouping examples according to Article 7.2(b) of the Variation Regulation (Cases for grouping variations listed in Annex III)**

1	One of the variations in the group is an extension of the marketing authorisation.	Other clinical or non-clinical changes linked to the extension (e.g. a new indication) can be grouped with the Extension application. Quality changes affecting the drug substance and/or drug product can also be included in the group.
	Example: Extension of the marketing authorisation for a new strength/pharmaceutical form + Type II variation for new therapeutic indication concerning the already authorised strength(s)/ pharmaceutical form(s)	
2	One of the variations in the group is a major variation of type II; all other variations in the group are variations which are consequential to this major variation of type II.	"A consequential variation is regarded as a change, which is an unavoidable and direct result of another change (i.e. the 'main change') and not simply a change which occurs at the same time."
	Example: Type II for new indication + Type IB or IA for addition of a new pack size required for the use in this new indication. Grouping of non-consequential quality changes may also be acceptable, under Article 7.2(c) other groups to be agreed with the Agency.	

**Table 2. Grouping examples according to Article 7.2(c) of the Variation Regulation (Cases for grouping variations agreed by the Agency)**

1	<i>Grouping of variations relating to active substance or finished product (but not to both)</i>	Grouping acceptable
	Example: type IB - extension of re-test period of the active substance + type IB - changes in the storage conditions of the active substance.	
2	<i>Grouping of variations relating to active substance and linked variations relating to finished product</i>	Grouping acceptable
	Example: type IB - changes to a test procedure of the active substance + type IA - deletion of a non-significant in-process control of the finished product.	
3	<i>Grouping of quality and administrative variations</i>	Grouping acceptable (administrative change can be combined with quality change when PI Annexes are affected).
	Example: type IB - extension of the shelf life of the finished product + type IA(IN) - change in the name of a manufacturer responsible for batch release + type IA - change in ATC Code.	
4	<i>Grouping of several non-clinical studies</i>	Grouping acceptable.
	Example: Provision of final study reports for 7 non-clinical in vivo studies, one of which results in consequential changes to the SmPC. The study report affecting the PI should be submitted as part of one type II variation under category C.I.4 and the remaining 6 reports as part of 6 type II variations under category C.I.13 (one variation per study report). As all 7 studies are non-clinical the scopes are related, and it is considered meaningful for these variations to be reviewed simultaneously. Thus, the MAH should submit one grouped application including one type II variation under category	

	C.I.4 and six type II variations under category C.I.13.	
5	<i>Grouping of several drug-drug interaction studies e.g. type II - interaction study with Rifampicin +type II - interaction study with oral contraceptive</i>	Grouping acceptable; 1 type II variation scope per interaction study but type II variations can be grouped in 1 application.
6	<i>Grouping of several safety changes with similar implementation timelines</i>	Grouping acceptable, provided that the variations are to be led by the same committee
	<p>Example 1: Update of section 4.4 of the SmPC with regard to venous thromboembolic events and haemorrhage events, and update of section 4.8 of the SmPC to include unrelated new ADRs, all following an update of the MAH's product core safety data sheet based on three different sets of data.</p> <p>The addition of information on venous thromboembolic events to SmPC section 4.4 is based on the analysis of one data set and requires one type II variation under category C.I.4.</p> <p>The addition of information on haemorrhage events to SmPC section 4.4 is based on the analysis of another data set and therefore requires one additional type II variation under category C.I.4.</p> <p>The addition of the new ADRs is in this case not consequential to the changes to SmPC section 4.4 above and is supported by another data set. Thus, the addition of the new ADRs to SmPC section 4.8 constitutes one additional scope and will therefore require an additional variation under category C.I.4.</p> <p>The applicant should in this case submit one grouped application including 3 type II variations under category C.I.4. The three variations are all related to clinical safety, they will be assessed by the CHMP and a common assessment is expected and is consequentially meaningful.</p>	
	<p>Example 2: Update of section 4.8 of SmPC to add three new ADRs - dyspnoea and chromaturia following a review of the MAH's safety database upon request by PRAC following a PSUSA procedure and Kounis syndrome following the MAH's own signal detection.</p> <p>As the three ADRs are supported by two separate data sets the MAH should submit two variations; one type II variation under category C.I.3.b to add dyspnoea and chromaturia and one type II variation under category C.I.4 to add Kounis syndrome. Both variations are related to clinical safety, but the assessment of the first variation is to be led by the PRAC while that of the second one will be performed by the CHMP; hence, the grouping is not acceptable in this case.</p>	
7	<i>Grouping of several variations affecting the product information with different recommended or expected approval timelines</i>	Grouping <u>not</u> acceptable
	<p>Example 1: Type IA(IN) to implement the outcome of signal assessment and type II safety variation.</p> <p>The implementation of the signal recommendation (which includes all language translations) is meant to allow the immediate implementation of the updated Product Information wording. Grouping with a type II variation would delay the implementation, therefore this is not acceptable.</p>	
	<p>Example 2: Type IB variation to implement agreed wording in the Product Information and type II</p>	

	<p>(non) clinical variation.</p> <p>In principle, the grouping is not acceptable as it would delay the implementation of the agreed wording due to longer timelines and possible need for linguistic review or the type II variation.</p> <p>Example 3: Type II variation to propose an extension of the authorised indication. In addition, the applicant proposes an update of the SmPC regarding hepatotoxicity based on a review of the MAH's safety data base undertaken upon request by the CHMP following a previous PAM assessment, and an update of section 4.4 of the SmPC regarding pulmonary toxicity following a literature review.</p> <p>Given the long assessment timelines for an extension of indication application and the fact that a grouped approach would delay the implementation of new safety information, the proposed grouping would not be acceptable. Hence, the extension of indication application should be submitted as a separate stand-alone type II variation under category C.I.6.a.</p> <p>As the two safety topics are supported by different sets of data they should be submitted as part of two separate type II variations under category C.I.4. However, as both scopes concern clinical safety they can be submitted as one grouped application.</p> <p>Thus, the applicant should submit one stand-alone type II variation under category C.I.6.a and one grouped application including two type II variations under category C.I.4.</p>	
8	<p><i>Grouping of variations affecting unrelated areas of the dossier</i></p>	<p>Not acceptable for grouping</p> <p>Example 1: Type II variation under category C.I.4 to provide 3-year clinical data based on an interim study report from study A with consequential changes to sections 4.8 and 5.1 of the SmPC. In addition, the applicant proposed to provide the final CSR for clinical study B with consequential changes to SmPC section 5.1, and the final CSR for a drug-drug interaction study C with consequential changes to SmPC section 4.5, as well as to take the opportunity to condense the existing text in SmPC section 4.8, to align the annexes with the latest QRD templates and to implement editorial changes in the SmPC.</p> <p>The provision of the interim data from study A and the consequential PI changes constitutes one type II variation under category C.I.4.</p> <p>The provision of the final CSR from study B with a consequential update to section 5.1 of the SmPC constitutes a separate assessment and therefore a separate type II variation under category C.I.4 is required.</p> <p>As both studies A and B are clinical (safety and/or efficacy) and affect SmPC section 5.1 it would be meaningful for these variations to be reviewed simultaneously.</p> <p>The final clinical study report for study C concerns a drug-drug interaction study which is not considered consequential or related and will require different expertise for the assessment (clinical pharmacology or non-clinical, depending on the nature of the drug-drug interaction study). Therefore, a separate type II variation under category C.I.4 should be submitted.</p> <p>The remaining proposed changes are considered relatively minor and can be included as part of the proposed application without the need for any additional scope i.e. any additional variation.</p> <p>Thus, the applicant should in this case submit one grouped application including 2 type II variations under category C.I.4 and one separate stand-alone type II variation under category C.I.4.</p>

9	<i>Grouping of variations in unrelated populations</i>	Not acceptable for grouping
	<p>Example 1: Data package supportive of 2 different indications e.g. renal cell carcinoma + non-small cell lung cancer. This would not be an acceptable grouping. Separate variations should be submitted. This is because the two indication changes may follow different timelines (i.e. number of Requests for Supplementary Information) and have different outcomes, so that the approval of one indication could be delayed because of the other.</p>	
	<p>Example 2: Provision of the final CSRs for 6 clinical phase 2 and 3 studies undertaken in the same patient population without consequential changes to the PI.</p> <p>The applicant should submit 6 type II variations under category C.I.13. As all 6 studies are clinical and provide safety and/or efficacy data in the same patient population, the scopes are considered related and it is considered meaningful for these variations to be reviewed simultaneously.</p> <p>Thus, the applicant should submit one grouped application including six type II variations under category C.I.13.</p>	

### **5.3. How shall I present a grouped variations application? *Rev. Aug 2020***

Grouped variations applications should contain the elements listed in Annex IV of the Variations Regulation and should be presented in accordance with the appropriate headings and numbering of the EU-CTD format.

The submission requirements as set-out in the PAG sections for the different types of variations will also apply to grouped variations, but the application should be provided as one integrated submission package (i.e. one eCTD sequence) covering all changes resulting from the variations.

- One cover letter, clearly indicating that the application concerns a group of variations as well as which type of variation is the highest in the group. Indicate whether the grouping is submitted under Article 7.2(b), i.e. it falls within one of the cases listed in Annex III of the variations regulation or it is submitted under Article 7.2(c), i.e. the grouping has been agreed with the Agency.
- In order to facilitate the registration of the submission, marketing authorisation holders are required to fill in all the submission attributes through the eSubmission delivery file UI.
- The completed electronic EU variation application form declaring all variations included in the group in the section 'type of changes', as well as a justification for the proposed grouping in the 'precise scope and background' section of the application form.
- The present-proposed section of the application form should clearly identify the relevant CTD sections in support of each variation
- If the group contains an Extension, also the Module 1.2 New Application Form duly completed for the Extension should be provided (see also "How shall I present my extension application?").
- Supportive documentation for all variations concerned, submitted as one integrated package (i.e. there is no need to submit a separate documentation package for each variation in the group). For example, the clinical overview and summaries should cover all data submitted as part of a grouped application i.e. all variations included. Hence the applicant should not submit several separate overviews/summaries.



- If applicable, one revised summary of product characteristics, labelling and/or package leaflet, including all changes applied for.
- Where the overall design and readability of the outer and immediate packaging and/or package leaflet is affected, the need for the provision of mock-ups or specimens should be discussed with the Medical Information Sector of the Agency on a case-by-case basis.

Please also refer to “How shall I present my Type II Variation application?”

For a (group of) Type IA/ IA<sub>IN</sub> variation(s) concerning several marketing authorisations, please refer to “How shall I present and submit my Type IA/IA IN Variation(s)?” and Harmonised eCTD Guidance.

## References

- Guidelines on the details of the various categories of variations, on the operation of the procedures laid down in Chapters II, IIa, III and IV of Commission Regulation (EC) No 1234/2008 of 24 November 2008 concerning the examination of variations to the terms of marketing authorisations for medicinal products for human use and veterinary medicinal products and on the documentation to be submitted pursuant to those procedures
- eCTD Variations Q&A document
- Harmonised Guidance for eCTD Submissions in the EU

## **5.4. What procedure number will be given to grouped variation applications? *Rev. Oct 2020***

- Several type IA/ IAIN variations affecting **one** medicinal product:

The usual EMA procedure number for type IA variations will be given, with the addition of the suffix “/G”.

*Example:* EMEA/H/C/prod\_nb/IA/nn/G

- One or more Type IA/ IAIN variations affecting **several** medicinal products:

The Agency will allocate a ‘high-level’ cross-products procedure number, which will be used for the handling of procedures which affect more than one medicinal product. A new procedure code (abbreviation) is used for groups of Type IA/ IA<sub>IN</sub> variations i.e. “IG”. As the ‘high-level’ number cannot be allocated to one single product, the procedure number will therefore contain “xxxx” as a placeholder for the product number.

*Example:* EMEA/H/C/xxxx/IG/002

This ‘high-level’ procedure number should be obtained from the Agency shortly before submission. To submit your request, raise a ticket via EMA Service Desk, using the Question option. The Type of question to be selected is “Request for high-level procedure or ASMF number” followed by sub-option “IG Procedure Number (Type IA grouping)” and attaching a draft cover letter.

If you do not have an EMA Account, you may create one via the EMA Account Management portal.

Please note that requesting this high-level number in advance is mandatory for submissions sent via the eSubmission Gateway or Web Client since this number must to be included in eSubmission Gateway XML delivery file User interface.

For each medicinal product concerned by the group of variations, the following grouping number (which includes a reference to the "IG" group to which it belongs) will be given.

*Example:* EMEA/H/C/prod\_nb/IG0002/nn which was submitted as part of a Type IA/ IA<sub>IN</sub> group affecting several medicinal products "IG0002")

- Several types of variations affecting **one** medicinal product:

The Agency's procedure number will reflect the highest type of variation in the group, with the addition of the suffix "/G".

*Example:* EMEA/H/C/prod\_nb/II/nn/G (grouping of Type II + Type IB variations)

*Example:* EMEA/H/C/prod\_nb/IB/nn/G (grouping of 3 Type IB variations)

*Example:* EMEA/H/C/prod\_nb/X/nn/G (grouping of Extension + Type II + Type IB variations)

MAHs are reminded that EMA procedure numbers are allocated by the Agency upon receipt of the application, according to a sequential order for the product concerned which is independent from the type of regulatory procedure submitted.

### **5.5. Can grouped variations be subject to a worksharing procedure? *Rev. Oct 2010***

Grouped variations can be subject to a worksharing procedure, provided that the same group of variations applies to all medicinal products concerned by the worksharing procedure. However, groups including an extension application are excluded from worksharing.

Based on Articles 7 and 20 of the Variations Regulation when the grouping only consists of Type IA/ IA<sub>IN</sub> variations affecting several marketing authorisations, this is considered as a "group" of variations and not a "worksharing" procedure. However, it is possible to include a group of Type IA/ IA<sub>IN</sub> Variation(s) with a Type IB or Type II variation, which is submitted for a worksharing procedure.

### **5.6. How will grouped variation applications be handled (timetable)? What will be the outcome of the evaluation of a grouped variation application? *Rev. May 2020***

A grouped variation application will be handled and will follow the review procedure of the 'highest' variation type in the group.

*For example:*

- a group of a type II and 3 type IB variations will follow the timetable of the type II variation.
- a group of an extension and a type II variation will follow the timetable of the extension.

When the group follows the timetable of the type II variation, weekly-start timetables may apply to the assessment following the same principles as those applied to the assessment of type II variations. For more information please refer to the following questions and answers from the post-authorisation guidance for type II variations: '*Which submission dates (weekly or monthly) are applicable for my*

*type II variation and when shall I submit my application?’ and ‘How shall my type II application be handled (timetable)?’*

In case of grouped type IA/ IA<sub>IN</sub> variations, the Agency will issue a Notification reflecting which variations are accepted or rejected. The MAH shall immediately cease to apply the rejected variation(s) concerned.

For grouping of other types of variations, where not all of the changes applied for can be positively validated, all valid and not valid variations will be clearly listed in the validation letter.

Upon finalisation of the review of the grouped variations, the Agency will issue an opinion/notification reflecting the final outcome of the procedure and in accordance with the ‘highest’ remaining approvable variation in the group. Such opinion/notification will therefore also list any variations which are not considered approvable, unless these have been withdrawn from the group by the holder during the procedure.

*For example:*

- Extension + type II --> extension evaluation procedure. Extension receives a negative assessment outcome (e.g. quality issues); type II (e.g. new indication) is however positive.

MAH withdraws the extension from the group --> CHMP will adopt a positive opinion on the type II variation only.

MAH does not withdraw the extension from the group --> CHMP will adopt a ‘composite’ opinion reflecting both the negative extension outcome as well as the positive type II.

- type II + type IB --> type II evaluation procedure. type II receives a negative assessment outcome; type IB is however positive.

MAH withdraws the type II from the group --> Agency will issue a positive notification on the type IB variation.

MAH does not withdraw the type II from the group --> CHMP will adopt a ‘composite’ opinion reflecting both the negative type II outcome as well as the positive type IB.

In any case, the assessment report will mention the initial and complete scope of the application (listing all variations initially included in the group) and will clarify the procedural timelines and steps taken during assessment.

For CHMP opinions on extensions and type II variations, the re-examination procedure set-out in Articles 9(2) and 34 (2) of Regulation (EC) No 726/2004 will apply. For further information please refer to the following questions and answers from the post-authorisation guidance for Type II variations ‘Which post-opinion steps apply to my type II variation and when can I implement the approved changes?’ and Extensions of marketing authorisations ‘How shall my extension application be handled (timetable)?’

## **5.7. How and when will the marketing authorisation be updated for grouped variations? *Rev. July 2013***

The post-opinion and decision-making process that will apply to grouped variations, will generally be that of the ‘highest’ type of opinion/notification issued at the end of the procedure.

For information on the post-opinion and decision-making process for type IA, IB and II variations, please refer to the following questions and answers '*How and when will the updated annexes become part of the marketing authorisation?*' and '*Which post-opinion steps apply to my type II variation and when can I implement the approved changes?*'

The decision granting the marketing authorisation following a grouped application will be amended, where necessary, within a year from the date of notification/CHMP opinion for the variation concerned with the exception of the following grouped variations:

- Groupings including an extension application, which will follow the decision-making process applicable to the extension application;
- Groupings including variation(s) listed in Article 23.1a(a), for which the amendments to the decision granting the marketing authorisation will follow a two-month timeframe;

Where a group of type IA/ IA<sub>IN</sub> variations to the terms of several MAs have been approved, the Commission will update the MA with one decision per product concerned, following the yearly decision-making timeframes for type IA/ IA<sub>IN</sub> variations.

### **5.8. What fee do I have to pay for grouped variations? *Rev. Apr 2021***

Grouped variations, whether consequential or not, will each attract a separate fee corresponding to the fee payable for the individual variation concerned.

Each variation applied for should therefore be declared as a separate variation on the variation application form.

The rules for reduced fees or fee reductions depending on the type of product (e.g. orphans, generics) will apply to grouped variations.

Where a grouping application is considered 'invalid' (i.e. an assessment process cannot be started), an administrative fee may be charged by the Agency.

Only one applicant will be invoiced for the grouped procedure. The details of the applicant where the invoice should be sent to should be clearly stated in the cover letter.

The fee will become due on the date of the notification of the administrative validation to the applicant and fees will be payable within 45 calendar days of the date of the said notification. After approximately 15 days an invoice will be sent to the applicants billing address held on the Agency's file.

The invoice will contain details of the product and type of procedure involved, the fee amount, the financial information and the customer purchase order number associated with the procedures invoiced (if provided in the eSubmission delivery file). The Agency does not accept stand-alone notifications of purchase order numbers that are not associated with a dossier.

Guidance on how to pay an invoice can be found on our website.

#### **References**

- More information about fees and fee payment in the centralised procedure

## 6. Worksharing of variations

### 6.1. What is worksharing and what types of variations can be subject to worksharing? *Rev. Oct 2013*

Article 20 of Commission Regulation (EC) N° 1234/2008 (the 'Variations Regulation') sets-out the possibility for a MAH to submit the same Type IB or Type II variation, or the same group of variations affecting more than one marketing authorisation from the same MAH in one application.

Applicants belonging to the same mother company or group of companies and applicants having concluded agreements or exercising concerted practices concerning the placing on the market of the medicinal product(s) concerned, have to be taken as "the same marketing authorisation holder" .

Extensions are excluded from worksharing.

Based on Articles 7 and 20 of the Variations Regulation, when a group of variations only consists of Type IA/ IA<sub>IN</sub> variations affecting several marketing authorisations, this is considered as a "group" of variations and not a "worksharing" procedure. However, it is possible to include a group of Type IA/ IA<sub>IN</sub> Variation(s) with a Type IB or Type II variation, which is submitted for a worksharing procedure. In such case, the review of the Type IA/ IA<sub>IN</sub> variation will be performed as part of the worksharing procedure.

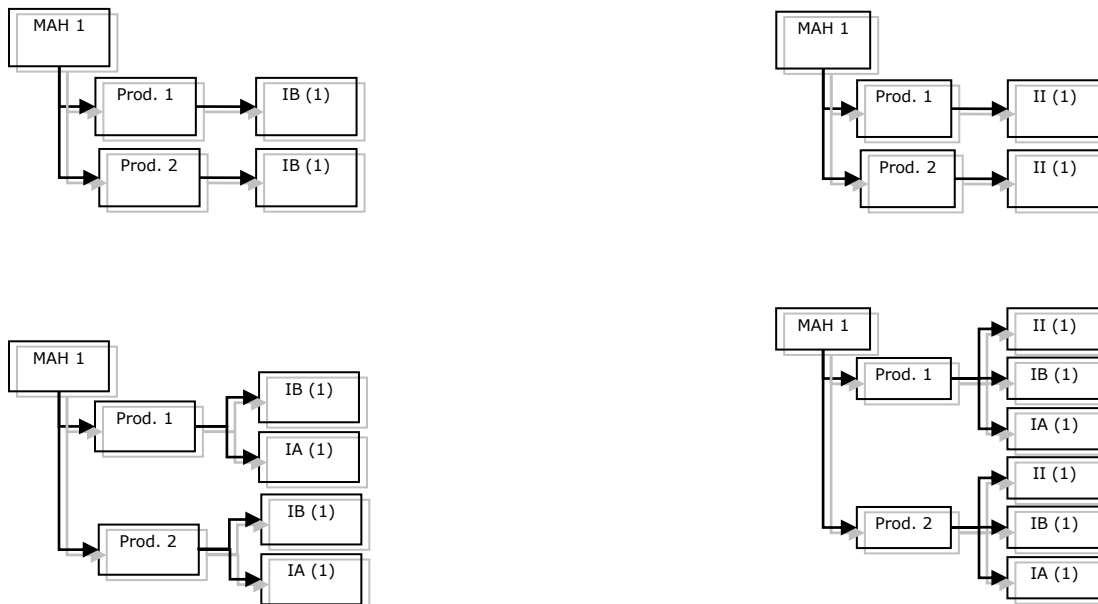

In order to avoid duplication of work in the evaluation of such variations, a worksharing procedure has been established under which one authority (the 'reference authority'), chosen amongst the competent authorities of the Member States and the Agency, will examine the variation on behalf of the other concerned authorities.

Where at least one of the concerned marketing authorisations has been authorised via the centralised procedure, the Agency will be the 'reference authority'. In all other cases, a national competent authority chosen by the Coordination Group, taking into account the recommendation of the holder, will act as the 'reference authority'.

Purely national marketing authorisations can be included in worksharing procedures submitted as of 4<sup>th</sup> August 2013.

## References

- Regulation (EC) No 726/2004
- Commission Regulation (EC) No 1234/2008 (OJ L334 of 12 December 2008)
- Commission Regulation (EU) No 712/2012 amending Regulation (EC) No 1234/2008 concerning the examination of variations to the terms of marketing authorisations for medicinal products for human use and veterinary medicinal products (OJ L209 of 4 August 2012)
- Guidelines on the details of the various categories of variations, on the operation of the procedures laid down in Chapters II, IIa, III and IV of Commission Regulation (EC) No 1234/2008 of 24 November 2008 concerning the examination of variations to the terms of marketing authorisations for medicinal products for human use and veterinary medicinal products and on the documentation to be submitted pursuant to those procedures

## **6.2. What variation(s) would be considered acceptable for worksharing?** **Rev. July 2013**

In order to benefit from a worksharing procedure, it is required that the same change(s) will apply to the different medicinal products concerned, with either no or limited need for assessment of a potential product-specific impact. Therefore, where the 'same' change(s) to different marketing authorisations require the submission of individual supportive data sets for each medicinal product concerned which each require a separate product-specific assessment, such changes will not benefit from worksharing.

Grouped variations can be subject to a worksharing procedure, provided that the same group of variations applies to all medicinal products concerned by the worksharing procedure.

Examples of changes which would be considered suitable for evaluation under worksharing:

### **Clinical/Pharmacovigilance**

- Changes to multiple generic MAs containing the same active substance
- Changes to single-substance MA and fixed-combination MA containing the same active substance
- Proposal for combination use, affecting both MAs
- Introduction or changes to the pharmacovigilance system

### **Quality**

- Changes to ASMF
- Update of CEP certificate
- Revision of test method for the active substance

Additional examples will be regularly included in this document, to reflect accumulated experience.

### **6.3. What pre-submission steps will apply to a worksharing procedure?** **Rev. Oct 2020**

In order to facilitate the planning of a worksharing procedure, MAHs are advised to inform the Agency at least 2 months in advance of the submission of a variation/group of variations to be subject to a worksharing procedure, together with an explanation as to why the holder believes that a worksharing procedure is suitable, by means of a 'letter of intent'.

The 'letter of intent' should provide the following information:

- Type(s) and scope of variation(s)
- Overview of MAs concerned
- Explanation that all MAs belong to the same MAH
- Explanation / justification for suitability of worksharing
- Rapporteurs, Reference Member States (RMS) and National Competent Authorities of the medicinal products concerned, if applicable
- MAH target submission date
- MAH contact person for the worksharing procedure

A template for such a 'letter of intent' is available on the Agency's website. To submit your request, raise a ticket via EMA Service Desk, using the Question option. The Type of question to be selected is "Request for high-level procedure or ASMF number" followed by sub-option "Workshare Procedure number". The letter of intent should be attached to the EMA Service Desk ticket.

If you do not have an EMA Account, you may create one via the EMA Account Management portal. Upon receipt of the letter of intent, the Product Lead (if the worksharing procedure contains at least one Type II variation) will review and decide whether the proposed worksharing procedure is acceptable. For worksharing procedures not including a Type II variation, the Agency appoints a Procedure Manager. Subsequently, the Agency will initiate the Rapporteur appointment procedure.

Following an 'Expression of Interest' and based on a rota system, the CHMP Chairman will appoint a Rapporteur (and Co-Rapporteur when the application includes a new indication) for the procedure. It is expected that the (Co-)Rapporteur will be one of the Rapporteurs of the centrally authorised medicinal products or a CHMP member representing one of the RMSs or National Competent Authorities for the nationally authorised products. The MAH will be informed accordingly.

A shorter pre-submission phase is envisaged, in cases where:

- a proposed worksharing procedure relates to multiple MAs for the same medicinal product authorised via the centralised procedure only;
- the variations subject to the worksharing procedure concern the implementation of urgent safety-related changes;
- the variations subject to the worksharing procedure concern the implementation of changes requested by CHMP.

#### **Worksharing procedure for multiple centrally authorised medicinal products ('duplicates')**

The submission of a formal letter of intent is not required, however applicants are advised to request a WS number. The request should be submitted by raising a ticket via EMA Service Desk, using the

Question option. The Type of question to be selected is "Request for high-level procedure or ASMF number" followed by sub-option "Workshare Procedure number" detailing the list of products, the intended submission date and the scope of variation they are planning to apply for (a draft cover letter is also accepted). Marketing Authorisation Holders are advised to submit such variations as usual.

#### **6.4. How shall I present a variation application under worksharing? Rev. Mar 2022**

The submission requirements as set-out in the PAG sections for the different types of variations will also apply to variations subject to worksharing, but the application should be provided as one integrated submission package (eCTD sequence) per product, covering all variations applied for. Please refer to the eCTD Variations Q&A document, for guidance on the submission of variations in eCTD format.

This will include a cover letter and electronic application form, together with separate supportive documentation for each medicinal product concerned and revised product information (if applicable) for each medicinal product concerned. If applicable, the MAH should provide a revised RMP for each medicinal product as part of the application upfront.

- One original cover letter addressed to the Agency and National Competent Authorities, in case nationally authorised medicinal products are part of the worksharing procedure, clearly indicating that the application is submitted for a worksharing procedure together with a short overview of all medicinal products concerned, with their respective Rapporteurs, RMSs and National Competent Authorities, as applicable. In case nationally authorised medicinal products are part of the worksharing procedure, the MAH should also include a confirmation that the worksharing applications have been submitted to all Member States where the products concerned are authorised and that the relevant national fees have been paid (when a WS application contains at least 1 CAP, the submission should be made to EMA only using the eSubmission Gateway. For further information please consult the document: Dossier requirements for NAPs). A formal letter with the worksharing applicant and contact person for the worksharing procedure should be provided with the worksharing application. A template cover letter for worksharing procedures including CAPs and nationally authorised medicinal products only is available on the Agency's website.
- One completed electronic EU variation application form, listing all medicinal products concerned and declaring all variations included in the group in the section 'type of changes', as well as a justification for the proposed worksharing (and grouping if applicable) in the 'precise scope and background' section of the application form. The response from the Agency on the acceptability of the worksharing application, further to the submission of the letter of intent should be attached to the application form.
- If nationally authorised medicinal products are part of the worksharing procedure, relevant product and Member State details should be provided as an Annex B to the application form (using the template available on the Agency's website)
- Supportive documentation for each product (including the revised summary of product characteristics, labelling and/or package leaflet, if applicable). This will allow the Agency and the national competent authorities to update the dossier of each marketing authorisation included in the worksharing procedure with the relevant amended or new information.



- Where the overall design and readability of the outer and immediate packaging and/or package leaflet is affected, the need for the provision of mock-ups or specimens should be discussed with the Medical Information Sector of the Agency on a case-by-case basis.
- In principle, identical modules 2-5 will have to be provided for each product included in the worksharing.

For queries relating to the presentation of the application, please contact the Agency.

## References

- Guidelines on the details of the various categories of variations, on the operation of the procedures laid down in Chapters II, IIa, III and IV of Commission Regulation (EC) No 1234/2008 of 24 November 2008 concerning the examination of variations to the terms of marketing authorisations for medicinal products for human use and veterinary medicinal products and on the documentation to be submitted pursuant to those procedures
- eCTD Variations Q&A document
- Template cover letter for worksharing procedures including CAPs and nationally authorised medicinal products only
- Template for Annex B
- Dossier requirements for NAPs (referral, PASS107, workshare, signal detection procedures) and ancillary medicinal substances in a medical device

## **6.5. How and to whom shall I submit my variation application under worksharing? *Rev. Mar 2022***

The worksharing application must be submitted at the same time to all relevant authorities, i.e. in case the application consists of centrally and nationally authorised medicinal products, the submission should be made to EMA only using the eSubmission Gateway. All NAP submissions (worksharing containing at least 1 CAP) sent to EMA via eSubmission Gateway/Web Client will be considered delivered to all National Competent Authorities representatives, alternates and experts of the scientific committees. No additional copies of submissions should be submitted directly to the NCAs on CD/DVD or via CESP as this might lead to validation issues and cause delays. All EMA submissions should be sent via EMA eSubmission Gateway/Web Client only.

## **Submission to the European Medicines Agency**

From 1 March 2014, the use of the eSubmission Gateway or Web Client is mandatory for all electronic Common Technical Document (eCTD) submissions through the centralised procedure. The European Medicines Agency (EMA) no longer accepts submissions on CD or DVD. This applies to all applications for human medicines.

More information on how to register and connect to the Gateway / Web Client can be found in the eSubmission website and detailed information on how to submit can be found in eSubmission Gateway guidance documents. Applicants must not send duplicate submissions electronically or via CD-ROM or DVD or via CESP as this might lead to delays in the handling of applications.

An automated acknowledgement is sent from the system confirming whether the submission has passed the relevant technical validation criteria and whether it has been uploaded to the Agency's review tool and made available via the Common Repository. Applicants must not send any accompanying hard media or separate paper cover letter as the cover letter will be in the relevant part of eCTD module 1 in PDF format.

Where applicable, revised product information Annexes (including Annex A, if applicable) should be included in electronic (Word and PDF) format in the same eSubmission Gateway or eSubmission Web Client package within a folder called 'working documents'. Where applicable changes in Word documents should be indicated using 'Tools-Track Changes'. Clean PDF versions should have all changes 'accepted'.

### **For Centrally Authorised medicinal products (eCTD mandatory)**

An electronic copy containing the relevant eCTD sequence for each product, should be submitted to the Agency. The coordinating Product Lead (if the worksharing procedure contains at least one Type II variation) or else the appointed Procedure Manager should be indicated in copy ("cc") on the cover letter.

### **For nationally authorised medicinal products (eCTD mandatory)**

eSubmission Gateway / Web Client package of the Variation application form and supportive documentation for each product should be submitted to the Agency in accordance with the "Dossier Requirements for referral, ASMF and NAP submissions (PASS107, Workshare, Signal Detection procedures) and ancillary medicinal substances in a medical device" document . Paper submissions are not accepted.

## **Submission to the National Competent Authorities**

Where nationally authorised medicinal products are part of the worksharing, the applications are submitted to the Agency only via the eSubmission Gateway and there should not be additional parallel submissions to Member States, even if some products are not relevant to some MSs. All submissions are available to all NCAs via the Common Repository. The Common Repository provides access to all involved Parties (The Agency, MSs and Committee Members) to receive the full data for the worksharing application.

If amendments are requested by the Agency as a result of the validation, updated documentation should also be submitted via the eSubmission Gateway/Web Client and it will be available to the network via the Common Repository.

## **Submission to the Rapporteur and Committee members**

All submissions sent to EMA via eSubmission Gateway/Web Client will be considered delivered to all National Competent Authorities' representatives and alternates.

The dossier requirements for post-authorisation submissions in the centralised procedure should be followed.

For a full overview of dossier requirements for National Competent Authorities of (Co-)Rapporteur and Committee members, including delivery addresses, please refer to the following document: Dossier requirements for Centrally Authorised Products (CAPs).

For requirements for non-eCTD format submissions, please refer to the "Dossier Requirements for referral, ASMF and NAP submissions (PASS107, Workshare, Signal Detection procedures) and ancillary medicinal substances in a medical device" document.

## References

- Commission Regulation (EC) No 1234/2008
- Commission Regulation (EU) No 712/2012 amending Regulation (EC) No 1234/2008 concerning the examination of variations to the terms of marketing authorisations for medicinal products for human use and veterinary medicinal products (OJ L209 of 4 August 2012)
- Electronic Variation application form
- Variation application form, The Rules governing Medicinal Products in the European Union, Notice to Applicants, Volume 2C
- Dossier requirements for Centrally Authorised Products (CAPs)
- Dossier Requirements for referral, ASMF and NAP submissions (PASS107, Workshare, Signal Detection procedures) and ancillary medicinal substances in a medical device
- Guidelines on the details of the various categories of variations, on the operation of the procedures laid down in Chapters II, IIa, III and IV of Commission Regulation (EC) No 1234/2008 of 24 November 2008 concerning the examination of variations to the terms of marketing authorisations for medicinal products for human use and veterinary medicinal products and on the documentation to be submitted pursuant to those procedures
- Article 5 Recommendation
- Harmonised Guidance for eCTD Submissions in the EU
- eSubmission website
- eSubmission Gateway Q&A
- eSubmission Gateway Web Client Q&A
- Common Repository website

## **6.6. What procedure number will be given to variation applications under worksharing? *Rev. Oct 2020***

The Agency will allocate a 'high-level' cross-products procedure number, which will be used for the handling of worksharing procedures affecting more than one medicinal product. A new procedure code (abbreviation) is used for worksharing procedures i.e. "WS". As the 'high-level' number cannot be allocated to one single product, the procedure number will therefore contain "xxxx" as a placeholder for the product number.

Example: EMEA/H/C/xxxx/WS/0003

For each medicinal product concerned by the worksharing procedure, the following worksharing number (which includes a reference to the "WS" procedure to which it belongs) will be allocated:

Example: EMEA/H/C/prod\_nb/WS0003/nn which was submitted as part of the 3<sup>rd</sup> worksharing procedure received by the Agency “WS0003”

Worksharing applications for a group of variations will include the suffix “/G” e.g. EMEA/H/C/xxxx/WS/0004/G and EMEA/H/C/prod\_nb/WS0004/nn/G.

For all worksharing procedures, including those which contain nationally authorised medicinal products, the ‘high-level’ procedure number should be systematically obtained from the Agency shortly before submission by sending your request via EMA Service Desk with a letter of intent, see question “What pre-submission steps will apply to a worksharing procedure?”.

### **6.7. How will variation applications under worksharing be handled (timetable)? What will be the outcome of the evaluation of a variation application under worksharing? Rev. Feb. 2015**

The MAH must submit the variation application for worksharing, at the latest by the recommended submission dates published on the Agency’s website (See also Human Medicines – Procedural Timetables / Submission dates).

In general, variations submitted for worksharing will follow the 60-day evaluation timetable of Type II variations and weekly-start timetables may apply to the assessment following the same principles as those applied to the assessment of Type II variations. The 60-day period may be reduced having regard to the urgency of the matter, particularly for safety issues, or may be extended to 90 days for Type II variations concerning changes or additions to the therapeutic indication.

For the detailed evaluation timetable, please refer to the PAG for Type II variations “How shall my Type II application be handled (timetable)?” For more information on the weekly-start timetables, please refer to: “Which submission dates (weekly or monthly) are applicable for my type II variation and when shall I submit my application?”

Upon finalisation of the review of the variations subject to the worksharing procedure, the Agency will issue an opinion reflecting the final outcome of the procedure. Such opinion will also list any variations (e.g. as part of a group, or for a specific medicinal product) which are not considered approvable, unless they had been withdrawn by the holder during the procedure. The same general principles as for grouped variations apply - see the PAG on grouping “What will be the outcome of the evaluation of a grouped variation application”?

Schematic structure of the CHMP Opinion and Annexes for an application under worksharing, consisting of centrally and nationally authorised medicinal products:

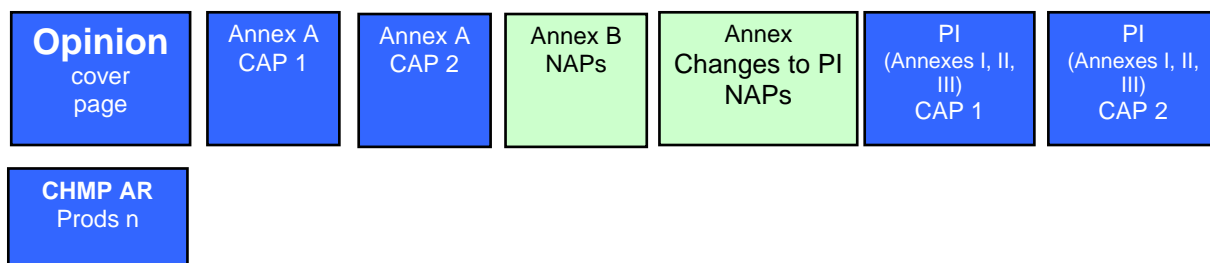

**Note:**

The Annex A for each centrally authorised medicinal product included in the worksharing procedure will be annexed to the CHMP opinion

The Annex B includes information on the nationally authorised medicinal products included in the worksharing application (if applicable). A template for the Annex B is available on the Agency's website.

### ***6.8. How and when will the marketing authorisations be updated following a worksharing procedure? When can I implement the approved changes?*** **Rev. Mar 2022**

Upon adoption of the CHMP Opinion on the worksharing procedure, the Agency will inform the MAH and Member States concerned (if applicable) as to whether the opinion is favourable or unfavourable (including the grounds for the unfavourable outcome), as well as whether the Commission Decision granting the Union marketing authorisations require any amendments.

Where the outcome of the procedure is favourable and the Commission Decision granting the Marketing Authorisation requires amendments, the Agency will inform the Commission accordingly.

#### **Re-examination**

Art. 9(2) of Regulation (EC) No 726/2004, also applies to CHMP Opinions adopted for worksharing procedures. This means that the MAH may give written notice to the Agency/CHMP that he wishes to request a re-examination within 15 days of receipt of the opinion (after which, if he does not appeal, the opinion shall be considered as final). The grounds for the re-examination request must be forwarded to the Agency within 60 days of receipt of the opinion. In case the MAH requests that the committee consults a SAG in connection with the re-examination, the applicant should inform the CHMP as soon as possible of this request.

The CHMP will appoint a different (Co-) Rapporteur, to co-ordinate the re-examination procedure. Within 60 days from the receipt of the grounds for re-examination, the CHMP will consider whether its opinion is to be revised. If considered necessary, an oral explanation can be held within this 60-day timeframe.

#### **Decision-Making Process for centrally authorised medicinal products**

Upon receipt of a favourable CHMP opinion which requires amendments to the decision granting the marketing authorisation, the Commission shall amend the marketing authorisation for each centrally authorised medicinal product to reflect the approved variation(s) within 2 months, for the variations listed under Article 23(1a)(a) or within one year for the other variations. A single decision will be issued for each centrally authorised medicinal product.

Article 23(1a)(a) provides for a two month timeframe for amending the decision granting the marketing authorisation for the following variations:

- Variations related to the addition of a new therapeutic indication or to the modifications of an existing one;
- Variations related to the addition of a new contra-indication;
- Variations related to a change in posology

- Variations related to changes to the active substance of a seasonal, pre-pandemic or pandemic vaccine against human influenza;
- Other Type II variations that are intended to implement changes to the decision granting the marketing authorisation due to a significant public health concern or significant animal health or environmental concern in the case of veterinary medicinal products.

All the other variations will follow a yearly timeframe for update of the respective Commission decision.

The Agency applies the existing post-opinion timeframes, as set-out in the Linguistic review process of product information in the centralised procedure – Human. The QRD linguistic check will be performed on one set of Annexes of one centrally authorised medicinal product. In case of comments, it will be up to the MAH to correctly implement the same amendments in the other centrally authorised products, as appropriate.

The Agency, in cooperation with the QRD members and the MAH will aim at providing final, checked translations for all centrally authorised products included in the worksharing procedure to the MAH at opinion stage in case of a worksharing procedure for a Type IB variation or by Day +27 in case of a worksharing procedure for a Type II variation. (See also: “When do I have to submit revised product information? In all languages?”).

## Timeline for Variations *Post Opinion*

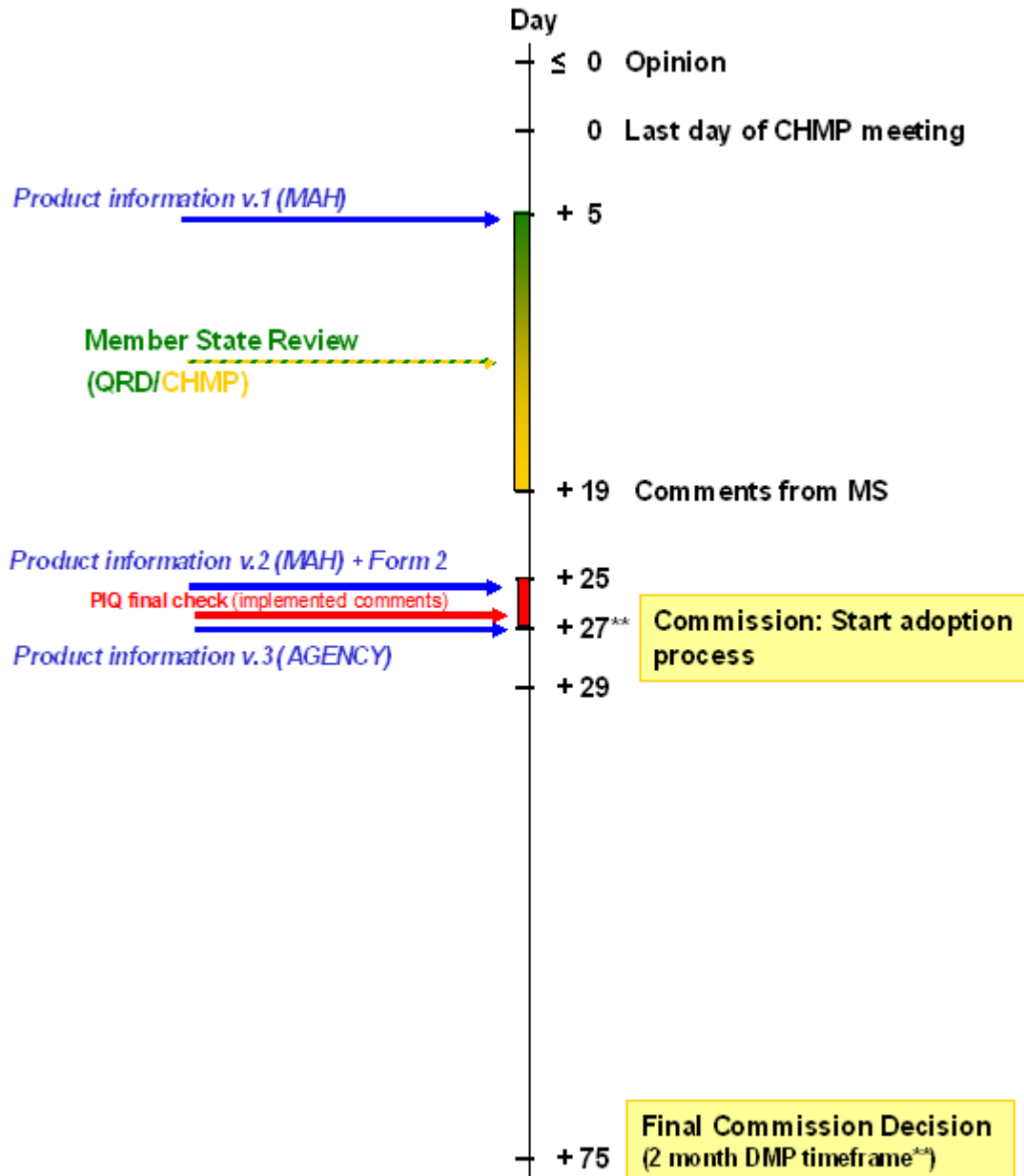

\*\* applicable only to Type II variations listed under Art. 23.1a(a) of Commission Regulation (EC) No 1234/2008

## **MA updating Process for nationally authorised medicinal products (if applicable)**

Upon receipt of the final opinion, the Member States concerned shall approve the final opinion, inform the Agency accordingly and where necessary, amend the national marketing authorisations within 60 days.

### **Implementation**

Type IB variations approved via a worksharing procedure, may be implemented upon receipt of the favourable CHMP opinion.

Type II variations listed in article 23(1a)(a) may only be implemented once the Commission has amended the marketing authorisation and has notified the MAH accordingly.

Type II variations approved via a worksharing procedure, which do not require any amendment of the marketing authorisation or which follow a yearly update of the respective Commission Decision can be implemented 30 days after receipt of the favourable CHMP opinion. The agreed change(s) should be included in the Annexes of any subsequent regulatory procedure.

Variations related to safety issues, including urgent safety restrictions, must be implemented within a timeframe agreed by the marketing authorisation holder and the Agency.

### **References**

- Regulation (EC) No 726/2004
- Commission Regulation (EC) No 1234/2008 (OJ L334 of 12 December 2008)
- Commission Regulation (EU) No 712/2012 amending Regulation (EC) No 1234/2008 concerning the examination of variations to the terms of marketing authorisations for medicinal products for human use and veterinary medicinal products (OJ L209 of 4 August 2012)
- Guidelines on the details of the various categories of variations, on the operation of the procedures laid down in Chapters II, IIa, III and IV of Commission Regulation (EC) No 1234/2008 of 24 November 2008 concerning the examination of variations to the terms of marketing authorisations for medicinal products for human use and veterinary medicinal products and on the documentation to be submitted pursuant to those procedures

### **6.9. What fee do I have to pay for variation applications under worksharing? *Rev. Apr 2021***

For information on the fees applicable for worksharing applications, please refer to the explanatory note on fees payable to the European Medicines Agency.

Where a worksharing application is considered 'invalid' (i.e. an assessment process cannot be started), an administrative fee may be charged by the Agency.

Only the worksharing applicant will be invoiced for the worksharing procedure. The details of the applicant where the invoice should be sent to should be clearly stated in the cover letter.

For information about fees and fee payment in the Centralised Procedure, please refer to the 'Explanatory note on fees payable to the European Medicines Agency'.



## References

- Explanatory note on fees payable to the European Medicines Agency

### **6.10. When do I have to submit revised product information? In all languages? Rev. Apr 2021**

In case the Variation(s) subject to worksharing affects SPC, labelling and/or package leaflet, the revised product information Annexes must be submitted as follows:

#### **a. Worksharing procedure for Type II variation(s)**

*At submission (Day 0)*

- English language: complete set of Annexes for all CAPs  
electronically only  
in Word format (highlighted)

*After CXMP Opinion (Day +5)*

- All EU languages (incl. NO+IS): complete set of annexes of one CAP  
electronically only  
in Word format (highlighted)

*After Linguistic check (Day +25)*

- All EU languages (incl. NO+IS): complete set of annexes for all CAPs  
electronically only  
in Word format (highlighted) and in PDF (clean)

Only one centrally authorised medicinal product will undergo a linguistic check. In the cases where the changes to the product information may vary between products, the product with the most complex changes will generally be the one subject to linguistic check.

#### **b. Worksharing procedures for Type IB variations**

*At submission (Day 0)*

- English language: complete set of Annexes for all CAP  
electronically only  
in Word format (highlighted)
- All EU languages (incl. NO+IS): complete set of annexes of one CAP  
electronically only  
in Word format (highlighted)

*Day +25 after start of procedure*

- All EU languages (incl. NO+IS): complete set of annexes of all CAPs  
electronically only  
in Word format (highlighted) and in PDF (clean)

For such procedures a linguistic review will take place in parallel to the scientific assessment. It is therefore expected that the texts provided at Day +25 after start of procedure will be the final texts.

**Overview:**

Day	Lang.*	Type II variation(s)	Type IB variation(s)
0	EN	Electronically Word format (highlighted) All CAPs	Electronically Word format (highlighted) All CAPs
	Other EEA	/	Electronically Word format (highlighted) One CAP
+5	All EEA	<b>After opinion</b> Electronically Word format (highlighted) One CAP	/
+25	All EEA	<b>After opinion</b> Electronically Word format (highlighted) PDF format (clean) All CAPs	<b>After start of procedure</b> Electronically Word format (highlighted) PDF format (clean) All CAPs

\* = complete set of Annexes i.e. Annex I, II, IIIA and IIIB submitted as one document per language

The 'complete set of Annexes' includes Annex, I, II, IIIA and IIIB i.e. all SPC, labelling and PL texts for all strengths and pharmaceutical forms of the product concerned, as well as Annex II. The complete set of Annexes must be presented sequentially (i.e. Annex I, II, IIIA, IIIB) as one document for each official EU language. Page numbering should start with "1" (bottom, centre) on the title page of Annex I. The 'QRD Convention' published on the Agency's website should be followed. When submitting the full set of Annexes in PDF format, this should be accompanied by the completed formatting checklist which provides guidance on how to correctly prepare the PDF versions.

The electronic copy of all languages should be provided as part of the variation application in the eCTD for the product concerned, on Gateway / Web Client. Highlighted changes should be indicated via 'Tools – Track changes'. Clean versions should have all changes 'accepted'.

Icelandic and Norwegian language versions must always be included.

The Annexes provided should only reflect the changes introduced by the Variation concerned. However, in exceptional cases where MAHs take the opportunity to introduce minor linguistic amendments in the texts (e.g. further to a specimen check) this should be clearly mentioned in the cover letter and in the scope section of the application form. In addition, the section "present/proposed" in the application form should clearly list the minor linguistic amendments introduced for each language. Alternatively, such listing may be provided as a separate document attached to the application form. Any changes not listed, will not be considered as part of the variation application.

In such cases and in cases where any other ongoing procedures may affect the product information Annexes, the MAH is advised to contact the Agency in advance of submission or finalisation of the procedure(s) concerned.

For those **variations which affect the Annex A** (e.g. introduction of a new presentation), the following principles apply:

Upon adoption of the opinion, the Agency will prepare and send to the MAH the revised English Annex A for each CAP reflecting the new/amended presentation.

After CHMP Opinion (Day +5), the MAH provides the Agency with the electronic versions of the complete set of Annexes in all languages, if applicable, as well as the translations of the revised Annex A for each CAP as a separate word document.

Please be reminded that in accordance with Union data protection requirements, no personal data should be included in the annotated product information annexes. This applies to the English version submitted at the time of opinion, the draft translation versions of the product information annexes in all languages submitted at Day+5 as well as the final translations submitted at Day+25. Please submit annotated product information annexes in an anonymised format (i.e. names of the reviewers removed from the track-changes). If you do not wish to do so, please ensure that the individuals whose data is included consented to its sharing with EMA and its further sharing by EMA with third parties such as other marketing authorisation applicants, marketing authorisation holders and National Competent Authorities, as relevant. EMA expressly disclaims any liability or accountability for the presence of unnecessary personal data in the annotated product information annexes submitted by the marketing authorisation holder.

## **Reference**

- The linguistic review process of product information in the centralised procedure - Human

## 7. Classification of changes

### 7.1. Administrative changes

#### 7.1.1. How should I submit changes to date of the audit to verify GMP compliance of the manufacturer of the active substance? (Classification category A.8)

According to the 'Variations Guidelines' 2013/C 223/01, this variation does not apply when the information has been otherwise transmitted to the authorities (e.g. through the so-called "QP declaration"). Otherwise transmitted means that the information has been provided to the competent authorities within any formal regulatory procedure e.g. renewals, variations. In these cases, no separate variation application for the change in the audit date has to be submitted. However, the change has to be mentioned in the scope of the application form as well as under "present/proposed" but not in the section "variations included in this application."

Manufacturer of finished product (as referred under documentation requirement 1 of classification category A.8) means any registered EEA manufacturers of medicinal products (finished product and batch release) which hold a valid manufacturing authorisation. This is the same as manufacturing sites which are required to provide a qualified person declaration, where a single declaration may be acceptable under certain circumstances – see note below under section on Quality Changes – Classification category B.II.b.1.

#### 7.1.2. How to apply for the deletion of more than one manufacturing site? **NEW Aug 2020**

In case more than one manufacturer in one MA has to be deleted a single variation of type IA under classification category A.7 to delete all manufacturing sites may be submitted. However, it has to be assured that there is still one approved manufacturing site left in the documentation performing the same function as the one(s) concerned by the deletion.

### 7.2. Quality changes

#### 7.2.1. Introduction of a new manufacturing site for the finished product. What changes can I submit under a single type II scope? (Classification category B.II.b.1) **Rev. Feb 2019**

The following complex related changes could be considered for submission under a single type II scope B.II.b.1 - Addition of a new finished product (FP) manufacturing site: changes to the manufacturing process, batch size and in-process controls to adapt to the new manufacturing site settings.

Complex related changes submitted under a single type II should always be clearly identified in the application form as following: a clear description of all the related changes should be provided in the precise scope. All the related changes should be listed in the present/proposed table.

Changes affecting the FP not directly related to the introduction of the new manufacturing site such as changes in excipients, specification parameters /limits for the FP, container closure system including suppliers should be submitted as additional variation scopes.

Any pre-submission queries of any intended submission of complex related changes under one single type II scope should be addressed to the Product Lead in charge of Quality Type II variations. See also question 'Who is my contact at the European Medicines Agency during type II variation including extension of indications?'

### **7.2.2. Introduction of a new manufacturing site for an active substance. What changes are covered by a single type II scope? (Classification category B.I.a.1) *Rev. Feb 2019***

The introduction of a new manufacturing site for an active substance supported by an ASMF should be submitted under a single Type II scope B.I.a.1.b. The introduction of a new manufacturer of the active substance not supported by an ASMF that requires significant updates to 3.2.S should be submitted under a single Type II scope B.I.a.1.g.

It should be noted that in cases where the introduction of the new active substance manufacturer has an impact at the level of the finished product manufacturer (e.g. changes to the active substance specifications or related analytical methods) separate variations have to be submitted under the corresponding B.I.b. categories and may be grouped together, if related to the introduction of the new active substance manufacturer.

Any pre-submission queries related to upcoming submissions pertaining to such changes should be addressed to the Product Lead in charge of Quality Type II variations. See also question 'Who is my contact at the European Medicines Agency during type II variation, including extension of indications?'

### **7.2.3. How should a change to Module 3.2.S or the update of an ASMF, which is part of Module 3 (human) of a marketing authorisation be submitted? (B.I.z) *Rev. Feb 2019***

The update of Module 3.2.S can be submitted as a grouped variation application, if conditions 5 or 6 of Annex III of the Variation Regulation (EC) No 1234/2008 apply.

An update or change of a stand-alone ASMF is not foreseen and can only be addressed in connection with a marketing authorisation. The type of the variation(s) is dependent on the type of the single changes introduced in the updated version. The update – including changes to the open and/or restricted part – can be submitted as a grouped application, if condition 5 of Annex III of the Variation Regulation (EC) No 1234/2008 applies.

However, in case of substantial changes in the updated version of Module 3.2.S or the ASMF it is recommended to submit a single type II variation under category B.I.z. However, it is a prerequisite for the validation of these single variations that the "present/proposed" section of the application form is filled in correctly and completely.

In all cases, updates of the ASMF must be submitted by the ASMF holder (open and closed part to EMA, open part to marketing authorisation holder) whilst the variation as such has to be submitted by the marketing authorisation holder. We encourage a close dialogue between MAH and ASMF holder to avoid validation issues.

Any pre-submission queries related to upcoming submissions pertaining to such changes should be addressed to the Product Lead in charge of Quality Type II variations. See also question 'Who is my contact at the European Medicines Agency during a type II variation, including extension of indications?'

#### **7.2.4. How should I submit a revised Certificate of Suitability (CEP)? (B.III.1a.2) Rev. Feb 2022**

In line with the Marketing Authorisation Holder's (MAH) obligation to keep the dossier up to date, a new or revised Certificate of Suitability (CEP) for an active substance (AS), excipient or starting material/reagent/intermediate used in the manufacturing process of the AS should be submitted as a variation. It is however understood that only the versions of the CEP (i.e. revised certificates) which were used in the manufacturing process of a batch of finished product (FP)/ AS need to be included in the dossier, provided that there are no quality and/or safety concerns that have led to the revision of the CEP.

In case of CEP revision related to quality and/or safety issues, the revised CEP should be implemented immediately and the appropriate variation should be submitted, even if the revised CEP is not linked to a specific production batch for the finished product.

CEP revisions should be submitted under the appropriate variation classification scope within subsection B.III.1. Each CEP revision should be submitted as a variation scope, i.e. an update covering more than one CEP version should be submitted as a grouped variation.

When submitting a revision of an approved CEP, the MAH should refer to the previously agreed version of the CEP within the 'Present/Proposed' section of the application form.

If with the submission one or more revisions of the CEP are omitted, the MAH should confirm in the variation application form (section 'Precise scope and background for change') that substance/material from the omitted CEP version(s) was not used in the manufacture of the FP and/or AS during the validity of this certificate(s). Additionally, it should be confirmed that any changes introduced by the omitted CEP revision(s), do not affect the quality of the AS and/or FP. In case such confirmation is missing, a negative Type IA notification may be issued.

The MAH should also clearly indicate in the 'Present/Proposed' section all changes introduced in the CEP between the latest approved version and the new revision, including all revisions that were not notified. Any changes e.g. to manufacturing sites, additional residual solvents introduced in the CEP by subsequent revisions should be declared.

#### **Example**

Submission of a revised CEP version for an already approved manufacturer: R0-CEP-xxxx-xx-rev02 when the current certificate in the dossier is: R0-CEP-xxxx-xx-rev00.

If during the validity of R0-CEP-xxxx-xx-rev01, material of the CEP was used in the manufacture of the FP and/or the AS, then the MAH should submit a grouping of two IA variations to include both certificates (rev. 01 and rev 02) in the Module 3. The foreseen conditions for each of the respective variations should be met.

If during the validity of R0-CEP-xxxx-xx-rev01, material of the CEP was not used in the manufacture of the FP and/or AS, the MAH should only submit a single Type IA variation to include the revised certificate R0-CEP-xxxx-xx-rev02 in Module 3. The foreseen conditions for the variation should be met.

The MAH should also confirm in the variation application form that material/substance from R0-CEP-xxxx-xx-rev01 was not used in the manufacture of the FP and/or AS during the validity of this certificate and that changes introduced by the revision R0-CEP-xxxx-xx-rev01 do not affect the quality

of the AS and/or the FP. MAH should also clearly list within the 'Present/Proposed' section of the application form all changes introduced to the CEP with revisions 01 and 02.

**7.2.5. What is considered to be a non-significant in-process control or specification parameter? (Classification category B.I.a.4.c, B.I.b.1.d, B.I.c.2.c, B.II.b.5.c, B.II.c.1.c, B.II.d.1.d, B.II.e.2.c and B.IV.2.f) *NEW Oct 2016***

Variation scopes B.I.a.4.c, B.I.b.1.d, B.I.c.2.c, B.II.b.5.c, B.II.c.1.c, B.II.d.1.d, B.II.e.2.c and B.IV.2.f of the 'Variations Guidelines' 2013/C 223/01, deal with the deletion of a non-significant in-process control (IPC) test or specification parameter. Provided all relevant conditions and documentation requirements are met, all these variations fall under the Type IA category (do-and-tell).

For the categories listed above and other variations related to specifications of active ingredients, excipients, finished product, packaging material or measuring or administration device, the deletion of an obsolete parameter is given as an example. For finished products, this is further exemplified by mentioning of odour and taste. Although it is not possible to give similar examples for all of the categories mentioned above, these examples serve as an indication of the types of changes considered to fall under this variation category, regardless if this is related to in-process controls or specifications. This is therefore intended to be used for truly obsolete tests that are no longer part of normal specifications for newer products but have remained for historical reasons in older products.

This variation category is not intended to include changes in relation to revisions of the control strategy with an intention to minimise redundant testing of parameters and attributes (critical or non-critical) that are tested at different stages during the production, or cases where process/ product characterisation performed after authorisation has shown that the attribute/ parameter is non-critical. Such changes require regulatory assessment and are to be handled as Type IB or II variations as appropriate.

**7.2.6. When applying for a new pack size, what is considered to be within /outside range? (Classification category B.II.e.5) *New Jun 2017***

The introduction of a new pack size (i.e. in addition to currently approved pack sizes) should be submitted as a variation scope B.II.e.5.a.

A range is defined from the smallest to the largest approved pack size (i.e. not from '0') for the same pharmaceutical form and strength. The pack size equals to the number of units of the pharmaceutical form (e.g. tablets, sachets, ampoules, etc.) contained in the outer packaging. Pack sizes not included within this range are considered to be outside of the range.

For the addition of a new pack size where the number of units of the pack is within the range of the currently approved pack sizes for the strength and pharmaceutical form, applicants should submit a IA<sub>IN</sub> variation B.II.e.5.a.1.

For the addition of a new pack size where the number of units of the pack is outside the range of the currently approved pack sizes for the strength and pharmaceutical form, applicants should submit a IB variation B.II.e.5.a.2.

In support of a timely introduction of new pack sizes to the market, EMA accepts the following approach for the introduction of various pack sizes falling outside the range within a single grouped submission. The biggest or the smallest pack size per strength outside the range should be classified

as IB variation B.II.e.5.a.2. This presentation defines the new limits of the range so that any intermediate pack size for the strength and pharmaceutical form can be classified as IA<sub>IN</sub> variation B.II.e.5.a.1.

### **Example 1**

The "Medicinal Product A" has currently two approved pack sizes of 30 and 60 tablets for the pharmaceutical form "film coated tablets" and the strength "20mg" and the MAH intends to apply for two new pack size(s) of 90 and 120 tablets at the same time.

The introduction of a new pack size of 120 tablets for the "20mg" strength is considered outside the range of packs and should be classified as variation B.II.e.5.a.2 (IB). This pack size defines a new limit for the range (30-120), so that the introduction of a pack size of 90 tablets as a grouped (or a latter) submission can be classified as a variation B.II.e.5.a.1 (IA<sub>IN</sub>).

The MAH should therefore apply for a grouped variation of 1 x Type IB - B.II.e.5.a.2 variation and 1x type IA B.II.e.5.a.1 variation.

### **Example 2**

The "Medicinal Product B" has currently two approved pack sizes of 2 and 10 pre-filled syringes for the pharmaceutical form "solution for injection" for both strengths of "20mg" and "40mg". The MAH is applying for four new pack sizes: 5 pre-filled syringes for the "20 mg" strength; 30 pre-filled syringes for the "20 mg" strength; 5 pre-filled syringes for the "40 mg" strength; 30 pre-filled syringes for the "40 mg" strength.

For the "20mg" strength, the introduction of a new pack size of 5 pre-filled syringes strength is considered within the range of approved packs (2-10) and should be classified as variation B.II.e.5.a.1 (IA) and the introduction of a new pack size of 30 pre-filled syringes is considered outside the range of approved packs (2-10) and should be classified as variation B.II.e.5.a.2 (IB).

For the "40mg" strength, the introduction of a new pack size of 5 pre-filled syringes strength is considered within the range of approved packs (2-10) and should be classified as variation B.II.e.5.a.1 (IA) and the introduction of a new pack size of 30 pre-filled syringes is considered outside the range of approved packs (2-10) and should be classified as variation B.II.e.5.a.2 (IB).

The MAH should therefore apply for a grouped variation application under the scopes referred above.

It should be highlighted, that for variations introducing additional presentations or pack sizes for centrally approved products, each additional presentation or pack size attracts separate fees (x additional presentations = x separate fees). Each presentation and pack size should therefore be declared as a separate variation on the variation application form under the section 'variations included in this application'.

Changes to strength, pharmaceutical form and route of administration are to be submitted as an Extension of a marketing authorisation.

For additional guidance on changes to existing presentation that can trigger new EU number(s) please see the EMA post-authorisation guidance for Type IA, Type IB and Type II variations.



### **7.2.7. How should I submit a new working cell bank (WCB)? (Classification category B.I.a.2 a) *New Jun 2017***

If a new WCB is introduced using the limits/conditions as detailed in an approved qualification protocol, the new WCB is covered by the existing quality assurance system and there is no need to submit a variation.

If the documentation of the WCB in the dossier does not include an approved qualification protocol for introducing new WCBs, the MAH should file a variation B.I.a.2 a type IB (as condition 5 is not met).

To introduce a qualification protocol for preparation of a new WCB, the MAH should file a variation type II B.I.a.2.c. The addition of the new WCB can be covered as part of this single variation type II.

Changes to an approved standard procedure (protocol) should be filed using a variation type IB B.I.a.2.a, or a variation type II B.I.a.2.c, as relevant depending on the complexity of the change. The addition of a new WCB can be covered as part of this single variation.

### **7.2.8. How should I submit a new reference standard for a biological medicinal product? *New Jun 2017***

If a new reference standard is introduced using the limits/conditions as detailed in an approved qualification protocol, the new reference standard is covered by the existing quality assurance system and there is no need to file a variation.

If no qualification protocol has been approved and the old material is still available and the MAH is able to provide comparability test results using both reference standards, the MAH should file a type IB variation either under B.I.b.2.e for Active Substance or under B.II.d.2.d for Finished Product.

If no qualification protocol has been approved and the old material is not available anymore and therefore no direct comparison new/old material is possible the MAH should file a type II variation either under B.I.b.2.d for Active Substance or under B.II.d.2.c for Finished Product.

To introduce a qualification protocol for the preparation of a new reference standard, the MAH should file a variation type II either under B.I.b.2.d for Active Substance or under B.II.d.2.c for Finished Product. Upon approval of the variation, the introduction of a new reference standard according to the protocol will be covered by the existing quality assurance system.

### **7.2.9. What changes in manufacturing sites, buildings and rooms are covered by the company Quality Assurance System (GMP)? *Rev. May 2018***

Provided that module 3 is not impacted, with the exception of section 3.2.A.1 (for biological medicinal products), the changes listed below (not an exhaustive list) are covered under the company's quality management system and do not require a variation to the Marketing Authorisation:

- Transfer of a manufacturing activity from one building to another in the same authorised site
- Transfer of a manufacturing activity from one room to another in the same authorised building
- Transfer of QC activity from one building to another in the same authorised site
- New filing line identical to an already approved one in an authorised room, building, manufacturing site
- New isolator in an authorised building

- New media or buffer preparation room in an authorised building
- Changes in the layout of an authorised manufacturing site

If as a result of any of the changes listed above, any amendments are introduced to module 3 (with the exception of section 3.2.A.1 for biological medicinal products), such as changes to the manufacturing site address detail, changes to the manufacturing process, changes to the batch size, etc., the MAH should file the appropriate variation(s).

**7.2.10. Changes in equipment used in the manufacturing process. What changes are covered by the company Quality Assurance System (GMP)?**  
**Rev. May 2018**

Provided that the new equipment is equivalent to the one currently used, and operates in the approved range of process parameters, the change is covered by company's quality assurance system.

If the introduction of new equipment has any impact on the processes and details registered in module 3 (with the exception of section 3.2.A.1 for biological medicinal products), the MAH should submit the appropriate variation(s).

**7.2.11. How should I update section 3.2.A.1 for Biotech medicinal products? New Jun 2017**

Notice to applicants for Medicinal products for human use (Eudralex – Volume 2B) establishes that information on facilities and equipment should be included in Appendix 3.2.A.1 for biotech medicinal products.

Any update of this section can be included as part of any upcoming variation affecting Module 3. In case the MAH wants to update this section and does not foresee any upcoming variation affecting Module 3 in the short/medium term, the MAH may consider submitting a Type IB variation (B.II.z).

**7.2.12. What do I need to consider if there are any changes to my medical device post-authorisation? NEW Aug 2017**

Commission Regulation (EC) No 1234/2008 ('the Variations Regulation') and the "Commission guidelines on the details of the various categories of variations, on the operation of the procedures laid down in Chapters II, IIa, III and IV of Commission Regulation (EC) No 1234/2008 and on the documentation to be submitted pursuant to those procedures" ('the Variations Guidelines') defines the conditions and requirements which must be met for any change (addition or replacement or deletion) to a measuring or administration device (classification B.IV.1). Depending on the change, the variation can be classified as either type IA(IN), IB or II. Given the relatively short timelines for variation procedures, for medical devices that do not form a single integral product at time of placing on the market and which are co-packaged with the medicinal product, the CE mark must be submitted as part of the documentation at time of submission of the variation to avoid any delays. The published timelines for the submission and evaluation of the respective variation will be followed.

### **7.2.13. How should I submit the transfer of test methods for testing of medicinal products to a new or already authorised testing site? Which variation classification category is applicable and what type of supporting documentation is expected? *Rev. Dec 2022***

Although, the need to submit a variation to approve an existing QC testing site for additional testing activities after analytical test transfer has been completed is not specifically foreseen by the current EC Variation Classification Guideline submission of a variation following by analogy the existing foreseen variation category B.I.a.1.j, B.II.b.2.b or B.II.b.2.c.3 may be necessary as outlined below under ii.

- i. In case of **physical, chemical and microbiological test methods** to be transferred to a **new** testing site (i. e. not yet listed in the dossier) submission of a variation is required (category B.II.b.2).

The documentation to be submitted is defined in the EC Variation Classification Guideline.

- ii. In the case of biological, immunological, or immunochemical test methods (e.g. in vivo bioassays, in vitro bioassays, enzymatic assays, binding assays, neutralisation assays, immunochemical assays) to be transferred to a **new** testing site or to an **already approved** testing site, a variation of type B.I.a.1 or B.II.b.2 is to be submitted.

The documentation should include at a minimum, the method transfer protocols in accordance with Eudralex Volume 4 Chapter 6 article 6.39 (which pre-define the acceptance criteria), from the old site to the new site (or new test laboratory). Depending on the variability of the specific method and the potential risk, to the quality, safety or efficacy of the product, posed by the proposed change, additional data such as a summary of the analytical method transfer test results may be required.

### **7.2.14. Do I need to record in the dossier a new manufacturing site for physical importation? *NEW Mar 2021***

The Member States shall ensure that the import of medicinal products into their territory is subject to an authorisation in accordance with Article 40(3) of Directive 2001/83/EC.

Please note that physical importation and batch certification of imported products are different operations that can take place at the same or different authorised manufacturing sites located in the in Union (EEA).

It is not a requirement to register in the dossier of your marketing authorisation the manufacturer(s) responsible for the physical importation of the finished product, hence no variations applications are required for changes in physical importation sites. The Manufacturing and Importation Authorisation (MIA) holder responsible for batch certification of imported medicinal products should ensure that the site(s) of physical importation is appropriately authorised for this operation. The physical importer needs to hold a MIA with an entry in section 2.3.1 according to the Union Format for MIAs. A technical agreement between the physical importer and the batch release site shall be in place. For more information on the certification by a QP and on batch release in the EU, also with regards to importation, see GMP annex 16.

### **7.2.15. How should I submit a new manufacturing site for the assembly of an integral medical devices? Which variation classification category is applicable and what type of supporting documentation is expected? **NEW Mar 2022****

The addition of a new manufacturing site for the assembly of an integral medical device (e.g. pen injector) where the different parts of a medical device are assembled to the primary packaging of a medicinal product to form an integral medicinal product should be submitted as a Type IB variation, classified under category B.II.b.1.z. The application form should clearly outline the “present” and “proposed” manufacturers. This change requires the assessment of supporting documentation including a description of the manufacturing operations performed by the integral medicinal product manufacturer together with critical process parameters and in-process controls, process validation, and batch data, if applicable.

A valid MIA/GMP certificate covering manufacturing operations for secondary packaging and/or finished product processing operations (indicating medical device assembly) should be provided as part of the submission.

## **7.3. (Non-) Clinical changes**

### **7.3.1. How should I submit a study protocol? **Rev. Dec 2016****

For imposed, non-interventional safety studies, the initial protocol submission should follow the provisions under Article 107n of Directive 2001/83/EC. Major amendments of such study protocol should be submitted under the provision of Article 107o of Directive 2001/83/EC (please also refer to guidance on PASS).

For other studies (i.e. non-imposed studies and/or interventional studies), if the initial assessment or the amendment of a study protocol does not result in a consequential change of the condition as reflected in Annex II and/ or the description of the study in the RMP it can be provided as a post-authorisation measure (PAM) (please also refer to guidance on post-authorisation measures).

Once agreed, the MAH can take the opportunity of a regulatory procedure affecting the RMP to include the final updated protocol in the appropriate RMP annex(es).

If the study description in the Annex II condition and/ or in the RMP is affected, the study protocol/ or the protocol amendment together with the proposed updated Annex II and/or RMP should be provided as part of a type II variation application under category C.I.11.b.

### **7.3.2. How should non-clinical and/or clinical study reports be provided? **Rev. Jul 2021****

In line with the 'Variations Guidelines' 2013/C 223/01 all 'final' non-clinical or clinical study reports concerning a marketing authorisation granted under the centralised procedure will have to be submitted to the Agency as part of a type II variation application, unless otherwise specifically covered in the annex to the classification guideline on variations or listed below:

- Results of imposed non-interventional safety studies covered by the Art. 107q of the Directive 2001/83/EC;

- Submissions of final study results in support of extension of marketing authorisation applications, annual renewals or annual re-assessments;
- Submission of study results related to paediatric population in line with Article 46 of Regulation 1901/2006. Submissions pursuant to Article 46 should continue to follow the procedure for post-authorisation measures, unless the MAH concludes that changes to the product information (PI) are warranted based on the data submitted. In such cases, the relevant variation should be submitted;
- Studies in the context of an environmental risk assessment (ERA). These are expected to be assessed during the initial marketing authorisation or relevant post-marketing procedures (e.g. extension of indication, extension applications). In the exceptional case that ERA study results are provided stand-alone, they should be submitted as a type IB C.1.z variation;
- Results including reports from bioequivalence studies to support quality changes to the marketing authorisation should be submitted under the applicable variation category for quality changes.

As a general rule, the 'final' study report is considered the one including the primary analysis of the study. In case the final study report has previously been submitted, further updates of data from the study without formal statistical significance after the primary analysis do not trigger additional variations, unless they lead to changes to the product information and/or to the Risk Management Plan (RMP). On the other hand, a formal extension study, generally with a different study design and objectives as compared to the initial study, is considered a separate study and it generally carries a separate study number. The submission of the final report for such an extension study triggers a variation.

When a change to the product information is proposed as a consequence of the final study report, the type II variation should be submitted under variation classification categories C.I.6 (extension of indication), C.I.4 (other changes involving the SmPC, Annex II, labelling and/or Package Leaflet) or C.I.11 (changes limited to the Annex II conditions). When no changes to the product information are proposed, the variation should be submitted under category C.I.13.

When a final non-clinical or clinical study report is provided as part of a variation submitted under category C.I.13, it should be noted that one separate type II variation per study report is required. This requirement applies also in situations where the CHMP has requested several non-clinical or clinical studies to be undertaken as part of a specific post-authorisation measure (PAM) in order to address a specific issue; one type II variation under category C.I.13 per final study report will still be requested (provided that the product information remains unaffected) .

It should be noted that these requirements also apply to all non-clinical studies, including the provision of final study reports for in vitro studies.

In case the final non-clinical or clinical study report leads to consequential changes to the RMP, the MAH can include an updated RMP version as part of the type II variation regardless of whether it is submitted under category C.I.6, C.I.4, C.I.11 or C.I.13.

With regard to 'interim' non-clinical or clinical study results, the timelines of the progress reports for a given study should be pre-specified and indicated in the protocol. These progress reports may include available interim results, but there is in general no obligation or recommendation to include interim results in RMPs unless required as part of an agreed pharmacovigilance plan. In this case, for CAPs, the specified progress report(s)/interim results should be submitted as PAM unless the MAH considers that the interim data would require consequential changes to the product information and/or the RMP

in which case a type II variation should be submitted instead. On the other hand, interim results should be reported in relevant PSURs.

When interim results have been requested by the CHMP and are provided in order to address a specific post-authorisation measure (PAM), the data should be submitted in line with the requirements of the PAM procedure, unless the MAH considers that the interim data result in consequential changes to the product information and/or the RMP in which case a type II variation should be submitted instead.

With reference to analyses across studies on specific topics (e.g. a biomarker report from more than one study) for which the individual final study reports have previously been submitted, the analysis should be submitted under category C.I.4 (in case of changes to the product information), under category C.I.11 (changes limited to the Annex II conditions) or as a PAM (no changes to the product information and/or the RMP are warranted). When the analyses should be submitted as variations, one variation scope per analysis (and not per study included in the analysis) should be submitted.

Final results from an imposed non-interventional post-authorisation safety study (PASS category 1 and 2 in the RMP, and reflected in Annex II) should be submitted within 12 months of the end of data collection unless a written waiver has been granted by PRAC, as appropriate (please refer to guidance on imposed post-authorisation safety studies). It should be noted that the submission of final results of imposed non-interventional studies should follow the relevant Art 107q of Directive 2001/83/EC procedure (please also refer to guidance on post-authorisation safety studies), regardless of whether or not the MAH considers that changes to the product information are warranted.

Any pre-submission queries in this regard should be addressed to the Product Lead.

### **7.3.3. What changes to the product information (PI) can be included as part of one type II variation? Rev. Feb 2019**

In principle, one change to the PI supported by one set of data constitutes one assessment and subsequently one scope i.e. one type II variation.

All data/study reports provided as part of a variation must support the same changes to the SmPC. If this is not the case, i.e. some data support one change (update A), and other data support another change (update B), it will be necessary to submit separate stand-alone variations or a group of variations, as appropriate; one variation for SmPC update A including the data supporting A, and one variation for SmPC update B including the data supporting B.

In the event that some of the data/study reports proposed to be part of an application do not support any of the proposed changes to the SmPC, the reports give rise to separate variation scopes (category C.I.13 – one variation per final study report as explained under 'How should non-clinical and/or clinical study reports be provided?'), which could potentially be grouped in the same submission or may need to be removed from the proposed variation application and submitted as a separate appropriate application.

Thus, only when changes are consequential to the same supporting data, can one type II variation application propose changes to several different sections of the SmPC as well as corresponding changes to the Package Leaflet. Any additional changes to the PI that are consequential to the assessment of another set of data will have to be submitted as part of a separate variation (stand-alone or part of a grouped application to be decided on a case-by-case basis).

Some theoretical examples are being provided below to illustrate the principles explained above.

## Example 1

Proposed application: Provision of final clinical study reports (CSR) for 3 PK studies (studies X, Y, Z).

- If the data from the 3 CSRs support the same SmPC updates, the reports should be submitted as part of one single type II variation under category C.1.4 (scope = 'update of the SmPC based on the results from studies X, Y and Z').
- If two study reports (X, Y) support one SmPC change (update A), and the 3rd study report (Z) supports a different SmPC change, the applicant should submit one type II variation under category C.I.4 for SmPC update A and one type II variation under category C.I.4 for SmPC update B. The two variations can in this case be submitted as part of a grouped application, as it makes sense to assess the 3 PK studies together (scope = 'update A of the SmPC based on the results of studies X and Y, and update B of the SmPC based on the results of study Z').
- If two study reports (X, Y) support all proposed SmPC changes and the 3rd study report (Z) does not result in any consequential changes to the SmPC at all, the applicant should submit a grouped application including one type II variation under category C.1.4 (studies X, Y) and one type II variation under category C.I.13 (study Z). The two variations can in this case be submitted as part of a grouped application, as it makes sense to assess the 3 PK studies together (scope = 'update of the SmPC based on the results of studies X and Y. The applicant also provides study Z as a grouped variation as a common assessment of these changes is considered meaningful').

## Example 2

Proposed application: Provision of one CSR for study A supporting SmPC changes regarding efficacy in patient population A and overall clinical safety, and one CSR for study B supporting SmPC changes regarding efficacy in patient population B and overall clinical safety.

- In view of the fact that the efficacy data are unrelated and concern two separate patient populations, two separate assessments will need to be undertaken and two separate type II variations will be required. However, as the scopes of the two variations are both partly related to overall clinical safety, it is meaningful to assess them together and the applicant should therefore provide the two variations as part of one grouped application.
- However, in the event that the data sets would be completely unrelated - e.g. because of different safety profiles in the two patient populations due to different posology - the reports should be provided as part of two separate stand-alone type II variations; one for patient population A (efficacy and safety) and one for patient population B (efficacy and safety).

## Example 3

Proposed application: Update of the SmPC section 4.8 in order to add three new ADRs; 'dyspnoea' and 'chromaturia' following a review of the MAH's safety database undertaken upon request by PRAC following a PSUSA procedure, and 'Kounis syndrome' following the MAH's own signal detection.

- As the three ADRs are supported by two separate data sets the MAH should submit two variations as part of a grouped application; one type II variation under category C.I.3.b to add 'dyspnoea' and 'chromaturia', and one type II variation under category C.I.4 to add 'Kounis syndrome'. Both variations are related to clinical safety and it makes sense to assess them together hence the acceptability of the grouping.

## Example 4

Proposed application: Type II variation under category C.I.6 in order to propose an extension of indication, which will include both non-clinical and clinical studies.

- Provided that all non-clinical and clinical data that will be submitted as part of the application are supportive of the new claimed indication, the studies should be provided as part of the application without the need for any additional variation.
- However, in the event that e.g. one of the non-clinical studies is not supportive of the proposed extension of indication, it will need to be submitted as part of a separate variation application (stand-alone or part of a grouped application to be decided on a case by case basis).

Any pre-submission queries in this regard should be addressed to the Product Lead.

### 7.3.4. How do I submit changes to the Summary of Pharmacovigilance System for medicinal products for human use?

As of 1 February 2016, changes to the summary of the pharmacovigilance system – changes in QPPV (including contact details) and/or changes in the Pharmacovigilance Master File (PSMF) location are to be notified to the authorities through the Art 57 database only without the need for any further variation. From that date MAHs are not required to notify EMA or national competent authorities (as applicable) of changes to the QPPV or PSMF data by submitting a type IAIN variation.

Upon a change in the QPPV or location of the PSMF, the Art 57 database should be updated by the MAH immediately to allow continuous supervision by the Competent Authorities.

Please also refer to Question How to inform the authorities of a change in the summary of the pharmacovigilance system? in the Pharmacovigilance system section of the Post-Authorisation Guidance.

#### References

- News Item: Regulatory information – Green light for reliance on Article 57 database for key pharmacovigilance information on medicines for human use in Europe
- Art 57 Reporting requirements for Marketing Authorisation Holders
- Detailed Guidance on electronic submission of information on medicines

### 7.3.5. How should I submit data requested as a follow-up to a prior regulatory procedure? **NEW Dec 2016**

Occasionally, the outcome of a regulatory procedure may require the MAH to follow-up on certain aspects in a subsequent regulatory submission. The type of submission required depends on the nature of the data requested and whether the implementation impacts the Product Information (PI) and/or the Risk Management Plan (RMP).

If the outcome of the prior regulatory procedure requests the submission of a (non-)clinical study report, this should always be submitted as a variation (unless this is a paediatric study submitted under Article 46 of the Paediatric Regulation (EC) 1901/2006). Any other requested information (e.g. cumulative safety review) should be submitted as a variation if it has impact for the PI or the RMP. In other cases, it can be accepted as a Post Authorisation Measure (PAM).



Similarly, if the prior procedure already recommends changes to the PI or the RMP, these should be submitted as variation, unless the MAH would like to provide a justification why such changes are not supported by the MAH. In the latter case, the rationale for not submitting a variation proposing the indicated PI and/or RMP changes and any requested data supporting the rationale can be submitted as a PAM. If however the data requested involves the submission of a final (non-)clinical study report, a variation should always be submitted even if no changes to the PI and/or RMP are proposed (with the exception of submissions under Article 46 of the Paediatric Regulation (EC) No 1901/2006).

The classification of the variation depends on the nature of the prior procedure the outcome of which is being implemented:

- for implementation of the outcome of a Union referral procedure, the applicable variation category is C.I.1.
- for implementation of the outcome of a PSUR, PASS protocol or PASS results procedure, the applicable variation category is C.I.3. It should be noted that PI changes resulting from PSUR data should ideally be implemented within the PSUR procedure itself; only if additional data are required to support the PI changes which cannot be submitted and assessed during the PSUR procedure should a follow-up variation of the C.I.3 category be submitted.
- in case of a procedure under article 46 of Paediatric Regulation No (EC) 1901/2006, the applicable variation scope is C.I.3 only in case changes to the PI are proposed. In principle, it is expected that in most cases PI changes are to be proposed. In the exceptional case that no changes to the PI are proposed, a PAM procedure should be applied for (see also question How should non-clinical and/or clinical study reports be provided?)
- for the implementation of the outcome of a signal assessment, the appropriate variation category is C.I.z, as also indicated in the CMDh Recommendation for classification of unforeseen variations according to Article 5 of Commission Regulation (EC) 1234/2008.
- for the alignment of the PI of a generic, hybrid or biosimilar medicine to that of the reference product the applicable variation category is C.I.2 with the exception of the implementation of wording from PSUR and PASS procedures; the applicable scope category in such cases is C.I.3.
- any other prior regulatory recommendation should be implemented via: a C.I.4 variation category, if changes to the PI are proposed; a C.I.11 variation category, if changes to the conditions in Annex II of the PI or in the RMP are proposed; a C.I.13 variation category, if a final (non-)clinical study report is being submitted; a PAM, if a paediatric final study report is being submitted under the requirements of Article 46 of Paediatric Regulation 1901/2006 and in all other cases where requested data and analyses are being submitted without an impact to the PI (including Annex II) and the RMP (please also refer to question Under which procedure should I submit my PAM?).

### **7.3.6. What is considered a new or modified therapeutic indication? **NEW Dec 2016****

Applications proposing changes to the therapeutic indication aiming to extend the target population (either by modifying an existing indication(s) or by extending in a completely new indication/target disease) trigger paediatric and orphan requirements (please refer to questions 'What aspects should I consider at time of submission of a Type II variation if there are orphan medicinal products designated or authorised for a condition related to my proposed therapeutic indication?', 'Do I need to address any paediatric requirements in my type II variation application?' , 'What aspects should I consider at time of submission of an extension application if there are orphan medicinal products designated or

authorised for a condition related to my proposed therapeutic indication?’ and ‘Do I need to address any paediatric requirements in my extension application?’ in the post-authorisation guidance for type II variations and Extension of Marketing Authorisations).

The EC Guideline on the elements required to support the significant clinical benefit in comparison to existing therapies of a new therapeutic indication in order to benefit from an extended (11-year) marketing protection and the EC Guideline on a new therapeutic indication for a well-established substance provide a definition of what is considered a ‘new indication’. More specifically, a new (or modified) indication is:

- a new target disease;
- different stages or severity of a disease;
- an extended target population for the same disease, e.g. based on a different age range or other intrinsic or extrinsic factors;
- a change from first-line treatment to second-line treatment (or second-line to first-line treatment), or from combination therapy to monotherapy, or from one combination therapy (e.g. in the area of cancer) to another combination;
- change from treatment to prevention or diagnosis of a disease;
- change from treatment to prevention of progression of a disease or to prevention of relapses of a disease;
- change from short-term treatment to long-term maintenance therapy in chronic disease.

However, in some particular situations a case-by-case assessment may be needed to determine whether the target population is extended. For example, the following may not be considered a new indication:

- information on the use of the medicinal product in the authorised target diseases in patients with renal or hepatic impairment;
- information on the use of the medicinal product in the authorised target diseases in pregnant women;
- for vaccines, information on the concomitant administration with other vaccines.

In addition to applications extending the target population, orphan similarity requirements are also triggered by any extension of the Marketing Authorisation (line extension, please refer to question ‘What aspects should I consider at time of submission of an extension application if there are orphan medicinal products designated or authorised for a condition related to my proposed therapeutic indication?’).

Paediatric requirements are triggered by an extension of the Marketing Authorisation (line extension) for new pharmaceutical forms and/or new routes of administration (please refer to question ‘Do I need to address any paediatric requirements in my extension application?’).

From a procedural point of view, extensions of indication can be submitted as type II variations or extensions of the Marketing Authorisation depending on whether the change in the target population is accompanied by other changes e.g. changes to the strength, pharmaceutical form, route of administration (please refer to question ‘When will my variation application be considered a Type II variation or an Extension application?’).

For extensions of the Marketing Authorisation, in case the change in the indication is only intended for the new pharmaceutical form/ strength being added, the extension of indication is covered by the scope of the MA extension application. In case the change(s) in the therapeutic indication also applies to existing presentations, the application should be presented as a grouping of a line extension(s) and C.I.6.a scope variation.

When the extension of indication is submitted as a type II variation application, the C.I.6.a scope category (i.e. addition of a new therapeutic indication or modification of an approved one) typically applies. However, not all variations under the C.I.6.a scope category are actual extensions of indication (e.g. restrictions of an existing indication also fall under this scope category). The contrary is also the case: there are variations which aim to extend the target population, but which do not affect the wording of the approved therapeutic indication in section 4.1 of the SmPC. so the variation category is not C.I.6.a but rather C.I.4 (changes in the Product Information due to new quality, preclinical, clinical or pharmacovigilance data). Ultimately, if the 'target population' is extended, the orphan and/or paediatric requirements are triggered, even though the variation may not have been submitted as a C.I.6.a 'extension of indication'.

## **7.4. Editorial changes**

### **7.4.1. What can be considered an editorial change and how can it be submitted as part of a type IA/IB/II variation? Rev. Jul 2021**

The European Commission 'Variations Guidelines' 2013/C 223/01 specifies that "If amendments to the dossier only concern editorial changes, such changes should generally not be submitted as a separate variation, but they can be included in a variation concerning that part of the dossier". Changes that can be classified as a variation as per Variations Guidelines are not considered editorial changes and should be submitted under the appropriate variation category.

### **Editorial changes in module 3**

Provided that the above condition is fulfilled, the following changes to the Module 3 may be considered editorial: adding headers for ease of use, reordering of existing information without changing the meaning, alignment of information among/within the sections provided that it can be demonstrated what is the correct reference that had been previously agreed (e.g. alignment of information in flow charts to process description), punctuation changes and grammar/orthographic corrections that do not alter the meaning of the text.

Examples of changes that cannot be considered editorial: removal of specification parameters or manufacturing description, update of information to bring the dossier content in line with the current manufacturing process, etc.

Editorial changes should always be clearly identified in the application form as follows: A brief description of the editorial changes should be provided in the Precise Scope. All the editorial changes should be listed in the **present/proposed table**, and a **justification** as to why the holder considers them 'editorial' (i.e. why they should not trigger a specific variation) should be **provided** for each change.

In addition, the MAH should provide a **declaration** in the 'Precise scope and background...' section of the application form confirming that the changes proposed as editorial do not change the content of

the concerned part(s) of the dossier beyond the scope of the variation within which the editorial changes are being submitted.

The Agency strongly recommends the submission of editorial changes within procedures with an administrative validation phase e.g. type IB or type II variations. This allows the appropriate review of proposed editorial changes during the administrative validation phase and the consequential amendment of the submission prior to assessment, if needed. The editorial changes proposed should affect the same part of the dossier concerned by the variation procedure i.e. fourth level of the eCTD dossier (e.g. "3.2.S.x" or "3.2.P.x"). For example, if a variation affects section 3.2.S.2.1 editorial changes can be submitted in sections from 3.2.S.2.1 to 3.2.S.2.7.

Exceptionally, the Agency may accept minor editorial changes as part of IA variations, if affecting the same eCTD section impacted by the variation submitted (i.e. at the fifth level 3.2.S.2.1). This is due to the fact that IA notifications are of administrative nature and do not have a validation phase. In case of doubt on the acceptability of editorial changes in future type IA applications, please contact the Agency by raising a ticket via EMA Service Desk, using the question option. The type of question to be selected is "Post-authorisation queries", followed by sub-option "Variation IA".

If you do not have an EMA Account, you may create one via the EMA Account Management portal.

MAHs are reminded to follow this guidance and ensure the high quality of variation applications in support of a timely processing of submissions.

The Agency expects MAHs to keep proportionality between the submissions of editorial changes versus the change which is the scope of the variation application. If the editorial changes affect sections in module 3 not impacted by any upcoming variation, the MAH may consider submitting these changes as a separate type IB variation (B.I.z or B.II.z respectively).

## **Editorial changes in module 4 and 5**

Editorial changes in module 4 and 5 are not foreseen. Please contact the Agency in advance of an upcoming submission by raising a ticket via EMA Service Desk, using the question option. The type of question to be selected is "Post-authorisation queries", followed by the relevant sub-option "Variation IA" or "Variation IB".

If you do not have an EMA Account, you may create one via the EMA Account Management portal.

## **Editorial changes to the product information in module 1.3**

Formatting changes, correction of typographical errors and/or mistakes to the English Product Information (PI) or other linguistic versions of the Product Information are considered editorial changes provided that the meaning of the text is not altered. These changes can be included within the scope of any upcoming variation impacting the product information.

Changes in the scientific content cannot be accepted as an editorial change. These changes should be classified under the scope of the relevant variation as per Variations Guidelines (e.g. Type II C.I.4). If no relevant scope is available, a variation type IB C.I.z may be appropriate.

Proposed changes that may require confirmation by the rapporteur or linguistic review will only be accepted by the Agency when submitted within the scope of an upcoming variation type IB or type II under chapter C which impacts the product information and where linguistic review is foreseen, if applicable.

Editorial changes should generally not be submitted as a separate variation and therefore no reference to a variation category is required. Should there be no upcoming variation to include the editorial changes, these could also be submitted as a stand-alone IB C.I.z if they affect the English SmPC. If they affect the PIL/labelling of all language versions an Art. 61(3) notification should be submitted. If other languages are affected and in case no variation affecting the product information is upcoming, the MAHs are advised to contact the Agency to discuss how to handle these necessary changes.

The MAH should liaise with the Agency without delay if the mistake concerns an incorrect or missing important information (e.g. contra-indication or adverse event) in the EN or any of the other languages, that could affect the safe and effective use of the medicinal product and/or lead to a potential medication errors (e.g. wrong strength, wrong posology, wrong route of administration).

The editorial changes should be clearly identified in the application form as editorial changes. A brief description of the editorial changes should be provided in the precise scope of the application form. Furthermore, editorial changes should be presented in the **present/proposed table** or provided as a separate Annex. A statement confirming that the proposed editorial change(s) do(es) not change the content of the previously approved Product information should be provided.

Any changes proposed by the applicants as editorial will be carefully considered by the Agency at time of submission and may be subject to further assessment at the same time as the variation. Proposed editorial changes that cannot be accepted as such will be rejected. In case of doubt, applicants can contact the Agency in advance of the planned submission by raising a ticket via EMA Service Desk, using the question option. The type of question to be selected is "Post-authorisation queries", followed by the relevant sub-option "Variation IA" or "Variation IB".

If you do not have an EMA Account, you may create one via the EMA Account Management portal.

## References

- Commission Regulation (EC) No 1234/2008 (OJ L334 of 12 December 2008)
- Commission Regulation (EU) No 712/2012 amending Regulation (EC) No 1234/2008 concerning the examination of variations to the terms of marketing authorisations for medicinal products for human use and veterinary medicinal products
- Guidelines on the details of the various categories of variations, on the operation of the procedures laid down in Chapters II, IIa, III and IV of Commission Regulation (EC) No 1234/2008 of 24 November 2008 concerning the examination of variations to the terms of marketing authorisations for medicinal products for human use and veterinary medicinal products and on the documentation to be submitted pursuant to those procedures
- CMDh Recommendation for classification of unforeseen variations according to Article 5 of Commission Regulation (EC) 1234/2008

## 8. Pre-submission queries service

### 8.1. What is the pre-submission queries service? *Rev. Mar 2022*

The pre-submission queries service is a service set up to respond to pre-submission queries that marketing authorisation holders (MAHs) may have in relation to the following post authorisation procedures: types IA and IB variations, type II variations (Non-clinical/Clinical/RMP), marketing authorisation transfers, Article 61(3) notifications, PSURs for Nationally Authorised Products (NAPs), and post-authorisation safety studies (under Article 107n/q) for Nationally Authorised Products.

The service aims to provide timely regulatory procedural pre-submission guidance to MAHs to facilitate the validation of these post-authorisation applications. It allows MAHs to receive specific regulatory guidance on planned applications and to discuss any pre-submission questions with a procedure manager before submitting an application.

This service does not address pre-submission queries for Quality type II variations, renewal applications (including annual re-assessment and annual renewal procedures), extension applications, post-authorisation measures (PAMs) and PSUR for centrally authorised products, for these applications, please contact the Product Lead responsible for the product. For initial marketing authorisation application a PL is assigned at the eligibility stage of the application and can be contacted for any pre-submission queries. For PSURs for Nationally Authorised Products (NAPs), and post-authorisation safety studies (under Article 107n/q) for Nationally Authorised Products please submit your query using the following web form (<https://www.ema.europa.eu/en/about-us/contact/send-question-european-medicines-agency>).

### 8.2. How should I send queries to the pre-submission queries service? *Rev. Mar 2022*

You should send queries by raising a ticket via the EMA Service Desk, using the Question option. The Type of question to be selected is "Post-authorisation queries", followed by the applicable sub-option:

- for Type IA variations: "Variation IA"
- for Type IB variations: "Variation IB A&B scopes" or "Variation IB C scopes"
- Type II variations: 'Variation II scopes (Non-clin/Clin/RMP)'
- for Marketing authorisation transfers: "MAH transfer"
- for Article 61(3) notifications: "Article 61(3) notification"

If you do not have an EMA Account, you may create one via the EMA Account Management portal.

To help the service deal with your query, please provide as much relevant information as possible in your correspondence, not forgetting to include the name of the product.

If you are uncertain about the type of intended submission, send your query using the sub-option most likely related to your procedure. If the pre-submission query is related to more than one procedure (e.g. both a type IA and type IB variation), please only raise one ticket. We will provide a consolidated response.

The pre-submission queries service should always be the first point of contact for the above-mentioned procedures, including for products with a high number of upcoming post-authorisation procedures

requiring detailed discussion where the product team would be involved. For PSURs for Nationally Authorised Products (NAPs), and post-authorisation safety studies (under Article 107n/q) for Nationally Authorised Products please submit your query using the following web form (<https://www.ema.europa.eu/en/about-us/contact/send-question-european-medicines-agency>).

### **8.3. How will my query be handles by the pre-submission queries service?**

A team of procedure managers with in-depth regulatory knowledge of procedures monitors all queries we receive. Your query will be assigned to a procedure manager specialising in the procedure concerned by your query. An internal peer review process of the response is in place to ensure consistency in the advices provided.

Queries received & advice provided to the MAHs are also recorded to ensure consistency of the responses provided and identify areas for improvement of the existing post-authorisation guidance published on the Agency website.

### **8.4. When can I expect to receive a response to my query? *Rev. May 2020***

The procedure manager will endeavour to send a response within 10 working days of the receipt of the query. You will receive along with your response the contact details of the procedure manager who handled your query in case you need further clarification, such as teleconference, related to the same query.

For complex queries where more internal consultation than usual is required, it may take more than 10 days to send a response. In those cases, you will be informed of the extra consultation and of the delay in sending you a response.

## 9. Changing the (Invented) Name of a Centrally Authorised Medicinal Product

### 9.1. Can I change the (Invented) Name of my CAP? *Rev. Oct 2013*

A medicinal product is authorised under the Centralised Procedure with a single name. In accordance with Commission Regulation (EC) No 1234/2008, the (invented) name of a medicinal product may be changed after authorisation through a Type IA<sub>IN</sub> Variation (No A.2).

This can be done either in case of a marketing authorisation being granted under INN (common name) together with a trademark or the name of the MAH or in case the MAH wants to change the initial invented name.

Such a Type IA<sub>IN</sub> variation is possible provided that the check by the Agency on the acceptability of the new name had been finalised and was positive before implementation of the new name. Immediately upon implementation of the change, the MAH must submit a Type IA<sub>IN</sub> variation notification to the Agency for review (see PAG on Type IA variations).

#### References

- Commission Regulation (EC) No 1234/2008 (OJ L334 of 12 December 2008)
- Commission Regulation (EU) No 712/2012 amending Regulation (EC) No 1234/2008 concerning the examination of variations to the terms of marketing authorisations for medicinal products for human use and veterinary medicinal products (OJ L209 of 4 August 2012)
- Guidelines on the details of the various categories of variations, on the operation of the procedures laid down in Chapters II, IIa, III and IV of Commission Regulation (EC) No 1234/2008 of 24 November 2008 concerning the examination of variations to the terms of marketing authorisations for medicinal products for human use and veterinary medicinal products and on the documentation to be submitted pursuant to those procedures
- Guideline on the acceptability of invented names for human medicinal products processed through the centralised procedure

### 9.2. Is the Invented Name (IN) checking procedure mandatory for the new proposed IN? *Rev. Oct 2013*

The checking procedure for the proposed IN is mandatory and is the same as that applied for new medicinal product applications, as described in the Agency pre-submission guidance (see also How will I know if the proposed (trade) name of my medicinal product is acceptable from a public health point of view?).

Therefore, Marketing Authorisation Holders are advised to submit the new proposed IN at the latest 4-6 months prior to their intended implementation of the new name and Type IA<sub>IN</sub> variation application since a final positive outcome of the checking procedure is required before implementation and submission of the Type IA<sub>IN</sub> Variation.



In order to enable applicants to propose names that will be acceptable for centrally approved medicinal products, it is crucial that the "Guideline on the acceptability of invented names for human medicinal products processed through the centralised procedure" (CPMP/328/98), is followed.

## References

- Commission Regulation (EC) No 1234/2008 (OJ L334 of 12 December 2008)
- Commission Regulation (EU) No 712/2012 amending Regulation (EC) No 1234/2008 concerning the examination of variations to the terms of marketing authorisations for medicinal products for human use and veterinary medicinal products (OJ L209 of 4 August 2012)
- Guideline on the acceptability of invented names for human medicinal products processed through the centralised procedure

### **9.3. How shall I present my IN change application? Rev. Feb 2019**

The application will follow the standard type IA variation dossier requirements as described in this guidance: See "How shall I present my Type IA Variation Notification". The MAH is therefore requested to provide:

**Module 1.0** a. Cover letter

**Module 1.2** b. Electronic Variation application form with the following attachments:

c. A copy of the relevant page(s) of the annex to the Variations Guideline. As requested in the application form, MAHs must tick the boxes in front of each condition and required documentation. It is recommended to add a reference to the location of each required document in the submitted dossier (e.g. 'Appendix 1', 'Appendix 2'...).

d. A copy of the Agency's letter of acceptance of the new name

**Module 1.3** e. Product information (Summary of Product Characteristics, Annex II, Labelling and Package Leaflet): see "Type I variations – When do I have to submit revised product information? In all languages?"

More information is available on 'Submitting a post-authorisation application'.

## References

- Commission Regulation (EC) No 1234/2008
- Commission Regulation (EU) No 712/2012 amending Regulation (EC) No 1234/2008 concerning the examination of variations to the terms of marketing authorisations for medicinal products for human use and veterinary medicinal products (OJ L209 of 4 August 2012)
- Guidelines on the details of the various categories of variations, on the operation of the procedures laid down in Chapters II, IIa, III and IV of Commission Regulation (EC) No 1234/2008 of 24 November 2008 concerning the examination of variations to the terms of marketing authorisations for medicinal products for human use and veterinary medicinal products and on the documentation to be submitted pursuant to those procedures
- Electronic Variation application form

- Variation application form, The Rules governing Medicinal Products in the European Union, Notice to Applicants, Volume 2C
- Guideline on the acceptability of invented names for human medicinal products processed through the centralised procedure

#### **9.4. Do I need to submit amended mock-ups/specimens with my variation?** **Rev. Oct 2013**

For information concerning submission of mock-ups and specimens in the framework of post-authorisation procedures, please refer to checking process of mock-ups and specimens of outer/immediate labelling and package leaflet of human medicinal products in the centralised procedure, 3.4 other post authorisation procedures.

#### **References**

- Checking Process of Mock-Ups and Specimens of outer/immediate labelling and package leaflets of human medicinal products in the Centralised Procedure (EMEA/305821/2006)

## 10. Annual Re-assessment

### **10.1. What is the annual re-assessment? *Rev. Dec 2015***

In exceptional circumstances and following consultation with the applicant, an authorisation may be granted subject to certain conditions, so called specific obligations (SOBs), in particular relating to the safety of the medicinal product, notification to the national competent authorities of any incident relating to its use, and action to be taken.

Such a marketing authorisation may only be granted when the applicant can show that they are unable to provide comprehensive data on the efficacy and safety of the medicinal product under normal conditions of use and must be based on one of the grounds set out in Annex I of Directive 2001/83/EC (rarity of the condition, state of scientific knowledge, ethical grounds).

Continuation of such a marketing authorisation shall be linked to the annual re-assessment of the conditions mentioned above. The SOB(s) may include an identified programme of studies to be conducted within a specified time period and aim at the provision of additional safety and efficacy data, e.g. a registry or an observational cohort study, where data is collected and reported annually based on an agreed protocol.

The outcome of the annual re-assessment will reflect the status of fulfilment of the SOB(s) and the impact of the SOB data on the benefit / risk profile of the medicinal product and will conclude on whether the marketing authorisation should be maintained, varied or suspended based on the review of these two elements.

#### **References**

- Directive 2001/83/EC, Article 22 and its Annex I, Part II.6
- Regulation (EC) No 726/2004, Article 14(8)
- Guideline on procedures for the granting of a marketing authorisation under exceptional circumstances

### **10.2. Are the CHMP Co-Rapporteur and the PRAC involved in the assessment? *Rev. Apr 2021***

The CHMP Co-Rapporteur is not systematically involved in the evaluation of the annual re-assessment application. The PRAC is systematically involved in the assessment and will focus on the assessment of the SOB data and any methodological aspects of the generation of these data in case they are falling within the definition of a non-interventional post-authorisation safety study (PASS). In this case the PRAC provides its expertise to the CHMP in terms of the assessment of the non-interventional PASSs and any potential changes to additional pharmacovigilance and risk minimisation activities proposed in the Risk Management Plan.

Note: For ATMP products, the CAT is the lead committee for the assessment of this type of products. References to the CHMP should be understood as CAT for ATMPs.

### **10.3. How shall I present my annual re-assessment application? Rev. May 2020**

Annual re-assessment applications should be presented as indicated below, in accordance with the appropriate headings and numbering of the EU-eCTD format.

In order to ensure that annual re-assessment applications are complete and correct before submitting them to the Agency, it is strongly recommended to use the pre-submission checklist for annual re-assessment of an MA under exceptional circumstances applications.

#### **Module 1: 1.0 Cover letter with the following documents attached:**

- A chronological tabulated summary table of the SOBs stating the following for each: description, reference number (preferably SIAMED number), due date indicated in Annex II of the Product Information, date of submission and procedure within which the SOB was submitted (if appropriate), and status.
- Revised list of pending SOBs (where applicable).
- A present/proposed table listing any changes introduced to the product information (incl. any minor linguistic amendment introduced for each language), if applicable.

The cover letter should indicate the time period covered by the annual re-assessment application.

In order to facilitate the registration of the submission, marketing authorisation holders are required to fill in all the submission attributes through the eSubmission delivery file UI.

**Note:** The Cover Letter should be signed by the person designated as MAH contact with the EMA. The Annual Re-Assessment application is not an opportunity to notify the Agency of changes in contact person, which should be notified separately. More information is available on 'Contacting EMA: post-authorisation'.

#### **1.3 Product Information**

##### **1.3.1 Summary of Product Characteristics, Labelling and Package Leaflet**

- If no changes to the PI (SmPC, Annex II, outer/inner labelling and Package Leaflet) are proposed by the MAH, clear reference to it should be made in the cover letter.
- If changes to the PI are proposed as part of the Annual Re-Assessment, a version of the PI in English, highlighting the changes proposed by the MAH should be provided in the eCTD and Word format. In addition, a 'clean' version of the PI should be provided in the eCTD and in Word format.
- Note: All other language versions are only to be submitted after adoption of the opinion (See also question - "When do I have to submit (revised) product information? In all languages?")

The Annexes provided should only reflect the changes introduced by the Annual Re-Assessment. However, if the PI update is already warranted by the annual re-assessment data, the MAH can also take the opportunity to implement changes due

to the revision of the SmPC guideline, other relevant guidelines impacting on the product information, or EMA/QRD product information templates and minor linguistic amendments. This should be clearly mentioned in the cover letter and list of such changes provided as an attachment to the cover letter. Any changes not listed will not be considered as part of the application.

#### **1.4 Information about the Expert**

1.4.3 Information about the Expert – Clinical (incl. Signature + CV)

1.8.2 Risk Management Plan

If an update of the RMP is proposed by the MAH as a consequence of SOB data submitted with the annual re-assessment application, section 1.8.2 should contain the updated RMP ('clean' version). A version of the RMP, highlighting the changes proposed by the MAH should also be provided in Word format.

#### **Module 2: 2.5 Addendum to Clinical Overview**

The Expert report addressing the data as well as the status of fulfilment of the SOBs and their impact on the overall benefit/risk balance of the medicinal product, in the form of a Clinical Overview update or addendum, based on the following structure (headings):

- Summary of information previously submitted to address ongoing SOBs
- Data submitted with the annual re-assessment to address outstanding SOBs
- Critical evaluation of status of fulfilment of each pending SOB

Clinical summaries and clinical study reports should not be included in section 2.5 but in the respective dedicated eCTD sections; see below.

#### **2.7 Clinical Summaries**

Clinical summaries will generally need to be updated, as appropriate, when new clinical study reports are submitted.

#### **Module 5: 5.3.5 Reports of Efficacy and Safety Studies (as appropriate) submitted to fulfil SOBs:**

5.3.5.1 Study Reports of Controlled Clinical Studies Pertinent to the Claimed Indication

5.3.5.2 Study Reports of Uncontrolled Clinical Studies

5.3.5.3 Reports of Analyses of Data from More Than One Study

5.3.5.4 Other Clinical Study Reports

#### **References**

- Directive 2001/83/EC, Article 22 and its Annex I, Part II.6
- Regulation (EC) No 726/2004, Article 14(8)

**10.4. Can I submit a PSUR with my annual re-assessment application? Rev. Dec 2015**

PSUR cannot be submitted within the annual re-assessment application.

**10.5. Can I submit an RMP with my annual re-assessment application? Rev. Aug 2017**

If SOB data submitted with the annual re-assessment warrant an RMP update, an updated RMP should be submitted. In such cases, it is recommended to liaise with the Agency in advance of the planned submission to agree on the details of such an update. When updates to the RMP are not warranted by newly submitted SOB data, an RMP should not be submitted within the annual re-assessment application.

If an updated RMP is already warranted as a consequence of the annual re-assessment data provided, some additional changes to the RMP may also be included in that RMP update (for further guidance please see question "Which changes can be included in an RMP update without the need for an additional variation?").

**10.6. When, how and to whom shall I submit my annual re-assessment application? Rev. Feb 2019**

**When:** The annual re-assessment application should be submitted on the anniversary date of the Commission Decision granting the Marketing Authorisation. Flexibility in the submission date could however be envisaged, in order to synchronise the annual re-assessment submission with the submission of data from the SOBs. The annual re-assessment application submission could be adjusted within a maximum of +/- 2 months in such cases.

Marketing Authorisation Holders are therefore advised to discuss and agree the annual re-assessment submission date with the Agency and the Rapporteur well in advance of the submission.

The MAH shall submit the annual re-assessment application at the latest by the recommended submission dates published on the EMA website. See also Human Medicines – Procedural Timetables / Submission dates).

**How and to whom:** More information is available on 'Submitting a post-authorisation application.'

Identical annual re-assessment applications for multiple Marketing Authorisations must be submitted separately. Each Marketing Authorisation is considered to be a stand-alone dossier. For this reason, no cross-references will be accepted and applications must be submitted for each concerned product as a complete and stand-alone document.

**10.7. How shall my annual re-assessment be handled (timetable)? Rev. Apr 2021**

The EMA will acknowledge receipt of a valid application of an annual re-assessment and shall start the procedure in accordance with the recommended starting dates published on the EMA website.

The submission deadlines and full procedural detailed timetables are published as a generic calendar on the EMA website (see: submission deadlines and full procedural timetables).

The published timetables identify the submission, start and finish dates of the procedures as well as other interim dates/milestones that occur during the procedure.

The annual re-assessment procedure will involve the CHMP and the PRAC.

**The following timetable shall apply:**

DAY	ACTION
Day 1	Start of procedure (see published dates on EMA website)
Day 60	Receipt of CHMP Rapporteur and PRAC Rapporteur Joint Assessment Report. Circulation CHMP and PRAC members.
Day 66	Comments from CHMP and PRAC members on the Joint Assessment Report.
Day 73-76	Discussion at PRAC Meeting (if required).
Day 90	At CHMP: - If no outstanding issues: adoption of opinion. - If outstanding issues: adoption of List of Outstanding Issues + decision on possible oral explanation by MAH
Day 91	MAH provides answers to list of outstanding issues to CHMP /PRAC Rapporteurs, CHMP/ PRAC members and EMA.
Day 96	CHMP Rapporteur and PRAC Rapporteur Joint Assessment Report. Circulation CHMP and PRAC members
Day 98	Comments from CHMP and PRAC members on the Joint Assessment Report
Day 103-106	Discussion at PRAC (if required)
Day 120	Adoption of CHMP opinion / possible oral explanation by MAH

Note: For Advanced Therapy Medicinal Products (ATMPs), the CAT is the lead committee for the assessment of this type of products (see: Timetable: Annual reassessment – ATMP).

**10.8. What could be the outcome of my annual re-assessment? *Rev. Dec 2015***

Depending on the assessment, one of the following outcomes can be envisaged:

- Maintenance of the MA considering that:
  - SOBs remain in place unchanged
  - Data from the SOBs do not require changes to the MA (e.g. changes to benefit risk profile of medicinal product and product information)

All SOBs will be reviewed again at the time of the following annual re-assessment together with their impact on the benefit/risk profile of the medicinal product.

- Variation of the MA considering that:
  - SOBs need to be modified; and/or
  - Data from the SOBs warrant changes to the MA (e.g. changes to benefit risk profile of medicinal product and/or product information)

All SOBs will be reviewed again at the time of the following annual re-assessment together with their impact on the benefit/risk profile of the medicinal product.

- Suspension/revocation of the MA considering that:
  - Data from the SOBs affect the benefit/risk profile of the medicinal product to the extent it warrants the suspension/revocation of the MA for the medicinal productor
  - The status of compliance with the SOBs is unsatisfactory and it is therefore considered that conditions to the marketing authorisation have not been fulfilled.
- Exceptionally, the CHMP may consider that all specific obligations have been fulfilled and comprehensive data on the efficacy and safety of the product is available. In such cases the CHMP may recommend granting a Marketing Authorisation not subject to specific obligations.

The Agency will subsequently forward the opinion to the European Commission, the Member States, Norway and Iceland and the Marketing Authorisation Holder together with the CHMP assessment report. The Decision-Making Process of the European Commission starts once the opinion with annexes in all official EU languages has been received.

When the annexes to the Marketing Authorisation have not been affected by the annual re-assessment, no Commission Decision will be issued.

#### References

- Directive 2001/83/EC
- Annex I to Directive 2001/83/EC, Part II.6
- Regulation (EC) 726/2004

### **10.9. Can I submit my annual re-assessment within the renewal? *Rev. Dec 2015***

The annual re-assessment of medicinal products authorised under exceptional circumstances cannot be part of the 5-year renewal procedure, as their scope is different.

#### References

- Guideline on the processing of renewals in the centralised procedure (EMEA/CPMP/2990/00) Rev.



### **10.10. Do I have to pay fees for an annual re-assessment?**

There is no fee payable for the annual re-assessment.

#### **References**

- Fees payable to the European Medicines Agency

### **10.11. What impact do ongoing Variation(s) (Type IA/IB or Type II) have on the annual re-assessment? *Rev. Dec 2015***

In case that an ongoing variation (Type IA/IB or Type II) affects the product information and is not yet finalised at the time of the submission of the annual re-assessment application, the last product information adopted/accepted by the EC/CHMP/EMA should be used in the submission of the annual re-assessment application by the MAH.

If the variation procedure is finalised (notification of a Type IA/IB or opinion of the Type II) before or upon finalisation of the annual re-assessment procedure, the accepted/adopted variation changes should be used in the product information adopted with the annual re-assessment.

MAHs are advised to contact the Agency in order to discuss how to optimally handle the above situations.

### **10.12. Do I have to submit mock-ups and specimens? *Rev. Dec 2015***

No mock-ups or specimens are required for the annual re-assessment of a marketing authorisation under exceptional circumstances.

### **10.13. When do I have to submit (revised) product information? In all languages? *Rev. Apr 2021***

Proposals for changes to the Annexes prompted by data submitted with the annual re-assessment application may be submitted as part of the annual re-assessment procedure. In such cases, the revised product information will be considered in the annual re-assessment opinion and implementation of changes will not initiate a separate variation procedure (see also Question "How shall I present my annual re-assessment application?", Section 1.3.1).

#### **At submission**

In case the annual re-assessment affects the SmPC, Annex II, labelling and/or package leaflet, the revised product information Annexes must be submitted as follows:

<b>Language</b>	<b>Format</b>
EN (only)	- As part of the eCTD  - Word format (highlighted and clean)

English language (only): complete set of Annexes within the eCTD sequence and in Word format (clean and highlighted showing the changes proposed as part of the Annual Re-Assessment).

In case the annual re-assessment results in changes to the SmPC, Annex II, labelling and/or package leaflet, the revised complete set of Annexes must be submitted as follows:

#### After CHMP Opinion (Day +5)

Language	Format
All EU languages (incl. EN, NO and IS)	Via Eudralink- Word format (highlighted)
All EU languages (incl. EN, NO and IS)	Via Eudralink- Word format (highlighted) - PDF format (clean)

All EU languages (incl. EN, NO and IS): complete set of Annexes in Word format (highlighted) and in PDF (clean)

#### After Linguistic check (Day +25)

Language	Format
All EU languages (incl. EN, NO and IS)	Via Eudralink - Word format (highlighted) - PDF format (clean)

All EU languages (incl. EN, NO and IS): complete set of Annexes in Word format (highlighted) and in PDF (clean)

Translations of the adopted product information in all EU languages (incl. EN, NO and IS) are to be provided electronically (in one Eudralink package) to the Member States Contact Points for Translations by Day +5 and copied to the EMA procedure assistant.

The 'complete set of Annexes' consists of Annex, I, II, IIIA and IIIB i.e. all SmPC, labelling and PL texts for all strengths and pharmaceutical forms of the product concerned and Annex related to the Art. 127a if appropriate.

Annexes must be presented sequentially (i.e. Annex I, II, IIIA, IIIB, and if applicable, Annex related to the Art, 127a) as one Word document for each official EU language. Annex related to the 127a (when applicable) must be presented as a separate PDF document with "127a" removed from the title page together with the Word files highlighted with tracked changes. All translations should be numbered as one document, starting with "1" (bottom, centre) on the title page of Annex I and Annex (127a) when applicable. The 'QRD convention' published on the EMA website defines format and layout of the PI. The PDF user guide should also be followed as it provides guidance on how to correctly prepare the PDF versions. When submitting the full set of Annexes in PDF format, this should be accompanied by the completed Day +25 checklist. Highlighted changes should be indicated via 'Tools – Track changes'. Clean versions should have all changes 'accepted'.

The revised Annex A, where applicable, is to be provided to the Agency as a separate Word document in all EU languages. See point 1.12 below.

The Decision-Making Process of the European Commission starts once the opinion with Annexes in all official EU languages, as appropriate, has been received. When the Annexes to the Marketing Authorisation have not been affected by the annual re-assessment, no European Commission Decision will be issued.

Note: Please be reminded that in accordance with Union data protection requirements, no personal data should be included in the annotated product information annexes. This applies to the English version submitted at the time of opinion, the draft translations submitted at Day +5 and the final translations submitted at Day +25. Please submit annotated product information annexes in an anonymised format (i.e. names of the reviewers removed from the track-changes). If you do not wish to do so, please ensure that the individuals whose data is included consented to its sharing with EMA and its further sharing by EMA with third parties such as other marketing authorisation applicants, marketing authorisation holders and National Competent Authorities, as relevant. EMA expressly disclaims any liability or accountability for the presence of unnecessary personal data in the annotated product information annexes submitted by the marketing authorisation holder.

### Reference

- The new Linguistic Review Process of Product Information in the Centralised Procedure (EMA/5542/02 Rev. 5)

### ***10.14. Will there be any publication on the outcome of my annual re-assessment? Rev. Dec 2015***

The EPAR (published on the EMA website) will be revised to reflect the CHMP conclusions in relation to the annual re-assessment procedure.

The CHMP meeting highlights published following each CHMP meeting gives information in its Annex on opinions in relation to annual re-assessment applications. This information includes the invented name of the product, its INN, the name of the MAH and the procedure outcome.

In case of an unfavorable opinion, recommending suspension or revocation of the MA, a Question and Answer (Q&A) document will be published by the Agency. This will include information and reasons for such an opinion. The information will be provided in lay language, so that it can be understandable for the general public.

### References

- CHMP meeting highlights
- EPARs

### ***10.15. Who should I contact if I have a question when preparing my application and during the procedure? Rev. Feb 2019***

If you cannot find the answer to your question in the Q&A when preparing your application or during the procedure, please contact the Product Lead responsible for your product.

## 11. Renewal

### **11.1. How long is my marketing authorisation valid for? Rev. Feb 2019**

In accordance with Article 14 (1-3) of Regulation (EC) No 726/2004, a marketing authorisation (MA) is valid for five years from the date of notification of the Commission Decision to the marketing authorisation holder (MAH) and is renewable upon application by the MAH.

Notification dates of the Commission Decision are published in the Official Journal and can also be found in the EC Pharmaceuticals - Union Register for each product. Once renewed, the MA will be valid for an unlimited period, unless the Competent Authority decides, on justified grounds relating to pharmacovigilance (e.g. exposure of an insufficient number of patients to the medicinal product concerned), to mandate one additional five-year renewal.

MAs under exceptional circumstances granted under Article 14(8) of Regulation (EC) No 726/2004 are also valid for 5 years.

Conditional MAs granted under Article 14-a of Regulation (EC) No 726/2004 do not fall under the above provisions. They are valid for 1 year and should therefore be renewed annually. For further information on the 'conditional' MAs, see Q&A of the pre-submission procedural guidance 'Could my application qualify for a conditional marketing authorisation?'.

#### **References**

- Article 14 (1-3) of Regulation (EC) No 726/2004
- Article 24 of Directive 2001/83/EC
- Guideline on the processing of renewals in the centralised procedure (EMEA/CHMP/2990/00 Rev.5)

### **11.2. When shall I submit my renewal application? Rev. May 2020**

In order to remain valid, the renewal of the MA is required within five years of its granting. A renewal application must be submitted to the Agency at the latest 9 months before the expiry date of the MA. A renewal application should also be submitted for suspended MA. If a MAH does not submit the renewal application, the MA will expire on the last day of its validity.

The MA validity period is calculated from the date of notification of the Commission Decision to the MAH.

To ensure that the Commission Decision on the renewal application is issued before expiry of the MA, when planning for their renewal submission, MAHs should take into account the following principles:

- The renewal application must be submitted at least 9 months before the MA expiry date. Any anticipation in the submission of the renewal application by more than 2 months (i.e. earlier than 11 months before the MA expiry) will not be accepted by the Agency.
- The start of the evaluation process will be the nearest possible starting date to the submission of a valid dossier, as published by the EMA in the "Human Medicines – Procedural Timetables / Submission dates".
- The PRAC/ CHMP assessment process can take up to 120 days of active time.

- The Decision-Making Process (including the Standing Committee consultation) for renewal procedures is 67 days.

## References

- Article 14(2) of Regulation (EC) No 726/2004
- Guideline on the processing of renewals in the centralised procedure (EMA/CPMP/2990/00 Rev. 5)
- Union Register of medicinal product: website of the European Commission

### **11.3. How shall I present my renewal application? Rev. May 2020**

Renewal applications should be submitted in eCTD format and have to contain the documents listed in the Annex 2 of the Guideline on the processing of renewals in the centralised procedure (EMA/CHMP/2990/00 Rev.5) and which are listed below:

#### **Module 1:**

**1.0 Cover letter.** The cover letter should be signed by the person designated as MAH contact with the EMA. (NB: the Renewal application is not an opportunity to notify the Agency of changes in contact person) In order to facilitate the registration of the submission, marketing authorisation holders are required to fill in all the submission attributes through the eSubmission delivery file.

**1.2 Renewal Application form.** The electronic EU Renewal application form (eAF) should be signed by the person designated as MAH contact with the EMA and completed with the following annexes (the form is available on the EMA public website):

- List of all authorised product presentations for which renewal is sought in tabular format (following the template for Annex A to CHMP Opinion)

The MAH should complete and sign the renewal application form, appending a list of all authorised strengths, pharmaceutical forms and presentations of the product concerned for which renewal is sought. In cases where the MAH does not wish to renew certain product presentations (e.g. a certain pharmaceutical form, strength or pack-size), this should be clearly indicated in the cover letter and the concerned presentations should not be included in the appended list.

- Details of contact persons:
  - Qualified person in the EEA for pharmacovigilance
  - Contact person in the EEA with the overall responsibility for product defects and recalls
  - Contact person for scientific service in the EEA in charge of information about the medicinal product

**Note:** The Renewal application is not an opportunity to notify the Agency of changes in contact persons. More information is available on 'Contacting EMA: post-authorisation'.

- List of EU Member states/Norway/Iceland where the product is on the market and indicating for each country which presentations are marketed and the launch date
- Chronological list of all post-authorisation submission since granting the MA or since the last renewal: a list of all approved or pending Type IA/IB and Type II variations, Extensions, Art 61(3)

Notifications, USRs, and PSURs, giving the procedure number (where applicable), date of submission, date of approval (if approved) and brief description of the change.

- Chronological list of conditions and Specific Obligations submitted since the granting of marketing authorisation or the last renewal indicating scope, status, date of submission and date the condition/ obligation was fulfilled (where applicable)
- Revised list of all remaining conditions and Specific Obligations (where applicable)
- A statement, or when available, a certificate of GMP compliance, not more than three years old, for the manufacturer(s) of the medicinal product listed in the application issued by an EEA competent authority or MRA partner authority. A reference to the Union EudraGMP database, if available will suffice.
- For manufacturing sites of the medicinal product not located in the EEA or in the territory of an MRA partner, a list of the most recent GMP inspections carried out indicating the date, the inspection team(s) and outcome of the inspection(s)
- In accordance with Article 46(f) of Directive 2001/83/EC manufacturing authorisation holders are required to use as starting materials only active substances which have been manufactured in accordance with the detailed guidelines on good manufacturing practice for starting materials as adopted by the Union.

The following declarations are required:

- A declaration by the Qualified Person (QP) of each of the manufacturing authorisation holders (i.e. located in the EEA) listed in the application form where the active substance is used as a starting material.
- A declaration by the Qualified Person (QP) of the manufacturing authorisation holder(s) listed in the application as responsible for batch release.
- These declarations should state that all the active substance manufacturer(s) referred to in the application form operate in compliance with the detailed guidelines on good manufacturing practice for starting materials.

### **1.3.1 Summary of Product Characteristics, Labelling and Package Leaflet**

- If no changes to the PI (SmPC, Annex II, outer/ inner labelling and Package Leaflet) are proposed by the MAH, a 'clean' version of the latest PI in English has to be provided (in Word format). This document is needed for the QRD review of the Product Information.
- If changes to the PI are proposed as part of the Renewal dossier, a version of the PI in English, highlighting the changes proposed by the MAH should be provided in Word format. In addition, a 'clean' version of the PI should be provided in the eCDT and Word.
- **Note:** All other language versions are only to be submitted after adoption of the opinion (See also "When do I have to submit revised product information? In all languages?").

## **1.4 Information about the Experts**

**1.4.1** Information about the Expert – Quality (incl. Signature + CV)

**1.4.2** Information about the Expert – Non-Clinical (incl. Signature + CV) – if applicable

**1.4.3** Information about the Expert – Clinical (incl. Signature + CV)

### **1.8.2 Risk Management Plan:**

An RMP is not systematically required as part of the renewal application. Three scenarios are possible:

- Where the MAH considers that no update to the RMP needs to be implemented, no RMP should be included in section 1.8.2 of the Renewal dossier. In this case, the MAH should specify this in the cover letter and provide a declaration in the clinical overview, confirming that the current approved RMP remains unchanged and applicable. Alternatively, if applicable, the MAH can state that an RMP update is being assessed in a procedure ongoing in parallel RMP changes are considered warranted.
- If an update of the RMP is proposed by the MAH with the Renewal application, section 1.8.2 should contain the updated RMP ('clean' version). In this case, in addition, a version of the RMP, highlighting the changes proposed by the MAH should be provided in Word format.
- Where there is no RMP for the medicinal product, this should be stated in the cover letter.

### **Module 2:**

#### **2.3 Addendum to Quality Overall Summary**

The Addendum should include a declaration of compliance with Article 16(1) of Regulation (EC) No 726/2004, which obliges the MAH "...to take account of technical and scientific progress and introduce any changes that may be required to enable the medicinal product to be manufactured and checked by means of generally accepted scientific methods".

The Addendum to the Quality Overall Summary should also include:

- Confirmation that all changes relating to the quality of the product has been made following applications for variations and that the product conforms to current CHMP Quality guidelines.
- Currently authorised specifications for the active substance and the finished product (with date of latest approval and procedure number)
- Qualitative and quantitative composition in terms of the active substance(s) and the excipient(s) (with date of latest approval and procedure number)

#### **2.4 Addendum to Non-clinical Overview**

An Addendum to the non-clinical Overview is not systematically required as part of the renewal application.

When new data are submitted in the non-clinical Addendum, a critical discussion must be submitted as part of the renewal application supporting the risk-benefit balance re-evaluation for the product taking into account any new non-clinical data accumulated since the initial MA or the last renewal, or any relevant new information in the public domain.

In case no new non-clinical data have been gathered since the initial MAA or since the last renewal, this should be stated in the Addendum to the Clinical Overview.

#### **2.5 Addendum to Clinical Overview**

A critical discussion should be provided within the Addendum to the Clinical Overview. It should address the benefit/risk balance for the product at the time of the Renewal, on the basis of the Periodic Safety Update Reports (PSUR) submitted and safety/efficacy data accumulated since the granting of the MA or since the last renewal, making reference to relevant new information in the public domain.

The discussion should clearly reflect the data previously included in the PSURs and the new data that have emerged since the DLP of the last PSUR up to the DLP of the renewal. The DLP of the renewal should not exceed 90 days prior to the renewal submission.

**Note:** MAHs are advised to consider the Good Vigilance Practice Module VII on PSUR as guidance for the preparation of the sections of the clinical overview described below.

The Addendum to the Clinical Overview should contain the following information:

- History of pharmacovigilance system inspections (date, inspecting authority, site inspected, type of inspection and if the inspection is product specific, the list of products concerned) and an analysis of the impact of the findings overall on the benefit/risk balance of the medicinal product.
- Worldwide MA status: overview of number of countries where the product has been approved and marketed worldwide.
- Actions taken for safety reasons during the period covered since the initial MA or since the last renewal until to the DLP of the renewal: description of all significant actions related to safety that had a potential influence on the benefit/risk balance of the approved medicinal product (e.g. suspension, withdrawal, temporary halt or premature ending of clinical trial for safety reasons, issue requiring communication to healthcare professionals...). Actions taken from the DLP of the last PSUR up to the DLP of the renewal should be clearly identified and highlighted.
- Significant changes made to the Reference Information (RI) during the period covered since the initial MA or since the last renewal. In this section, new changes made from the DLP of the last PSUR up to the DLP of the renewal should be clearly highlighted.
- Estimated exposure and used patterns: data on cumulative exposure of subjects in clinical trials as well as of patients from marketing exposure for EU and non-EU regions. If the MAH becomes aware of a pattern of use of the medicinal product considered relevant for the implementation of the safety data, a brief description should be provided; such patterns may include in particular off-label use.
- Data in summary tabulations: Summary tabulations of serious adverse events from clinical trials as well as summary tabulations of adverse reactions from post-marketing data sources reported during the period covered since the initial MA or since the last renewal until to the DLP of the renewal.
- Summaries of significant safety and efficacy findings from clinical trials and non-interventional studies during the period covered by the renewal: description of any significant safety findings that had an impact on the conduct of clinical trials or non-interventional studies. It should also address whether milestones from post-authorisation safety studies, post-authorisation efficacy studies, studies included in the pharmacovigilance plan of the RMP and studies conducted as condition or specific obligations of the MA, have been reached in accordance with agreed timeframes. New data since the DLP of the last PSUR up to the DLP of the renewal should be highlighted.
- Overview of signals: High level overview of signals for which evaluation was completed during the period covered by the renewal and any action taken or planned; and high-level overview of ongoing signals (i.e. that are undergoing evaluation at the DLP of the renewal application) should be provided. The information should be provided in tabular format.
- Signal and risk evaluation: the MAH should summarise signals for which evaluation was completed during the reporting period of the renewal. For signals that became important identified or



potential risks or are related to a known risk, a characterisation of the risk should be provided. Evaluation of signals completed from the DLP of the last PSUR to the DLP of the renewal should be clearly highlighted. The MAH should discuss whether any changes are considered necessary to the existing safety concerns and whether any additional risk minimisation activities for the product are warranted, considering the data collected during the period covered by the renewal.

- Relevant information on patterns of medication errors and potential medication errors (even when not associated with adverse outcomes) during the period covered by the renewal. Such information may be relevant to the interpretation of safety data or the overall benefit/risk balance evaluation.
- Literature: review of important literature references published during the period covered since the initial MA or since the last renewal until the DLP of the renewal that had a potential impact on the benefit/risk balance of the medicinal product.
- Benefit evaluation: the MAH should summarise important efficacy and effectiveness information (including information on lack of efficacy) for the period covered since the initial MA or since the last renewal until the DLP of the renewal.
- Benefit/risk balance: a discussion on the benefit/risk balance for the approved indication should be presented, based on the above information.
- Late-breaking information: The MAH should summarise the potentially important safety, efficacy and effectiveness findings that arise after the DLP of the renewal but during the period of preparation of the addendum to the clinical overview.

The Clinical Expert Statement should:

- Confirm that no new clinical data are available which change or result in a new benefit-risk balance evaluation.
- Confirm that the product can be safely renewed at the end of a 5-year period for an unlimited period, or any action recommended or initiated should be specified and justified.
- Confirm that the authorities have been kept informed of any additional data significant for the assessment of the benefit/risk balance of the product concerned.
- Confirm that the product information is up to date with the current scientific knowledge including the conclusions of the assessments and recommendations made publicly available on the European medicines web-portal.

It should be noted that the responsibility for the quality of the submitted documentation lies with the MAH and is crucial to the overall process. For queries relating to the application, please contact the Product Lead responsible for the product.

In order to ensure that renewal applications are complete and correct before submitting them to the Agency, it is strongly recommended using the pre-submission checklist for 5-year renewal applications.

## References

- Guideline on the processing of renewals in the centralised procedure (EMA/CPMP/2990/00 Rev. 5)
- Electronic Renewal application form

#### **11.4. How and to whom shall I submit my renewal application? Rev. Feb 2019**

**How:** The requirements for the submission of applications related to the centralised procedure are provided on the EMA website. Information is available on 'Submitting a post-authorisation application'.

**To whom:** To the EMA, CHMP, PRAC and CAT (when involved) members, submissions via the Common Repository only.

#### **11.5. How shall my renewal application be handled (timetable)? Rev. Aug 2016**

The MAH must apply for a renewal no later than 9 months before the expiry date of the MA. The recommended submission dates published on the EMA website will apply in order to determine the start of the procedure.

The Agency will acknowledge receipt of a valid renewal application and shall start the procedure in accordance with the recommended starting dates published on the EMA website. The MAH will be informed of the adopted timetable at the start of the procedure.

The timetable for the scientific evaluation by the PRAC and the CHMP will be set in order to allow the Commission Decision to be adopted before the expiry date of the MA. Please refer to Annex 1 of the Guideline on the processing of renewals in the centralised procedure (EMA/CPMP/2990/00 Rev. 5).

Full procedural detailed timetables are published as a generic calendar on the EMA website (see: submission deadlines and full procedural timetables).

The published timetables identify the start and finish dates of the procedures as well as other interim dates/milestones that occur during the procedure.

The renewal procedure will involve the CHMP Rapporteur and the PRAC Rapporteur appointed for the medicinal product.

Day 1	Start of procedure (see published dates on EMA website)
Day 60	Receipt of Joint CHMP Rapporteur / PRAC Rapporteur AR. Circulation to EMA, CHMP, PRAC members and MAH, highlighting major issues if any.
Day 66	Deadline for comments from CHMP, PRAC members on the Joint AR.
Day 73-76	When applicable, discussion at PRAC Meeting.
Day 76	Endorsement of the Joint Assessment Report (PRAC outcome)
Day 90	Discussion at the CHMP (if applicable): - If no outstanding issues: adoption of opinion. - If outstanding issues: adoption of List of Outstanding Issues
Day 91	MAH provides answers to list of outstanding issues to CHMP /PRAC Rapporteur, CHMP, PRAC members and EMA.

Day 96	Revised AR from CHMP and PRAC Rapporteurs. Circulated to CHMP and PRAC members and MAH
Day 98	Comments from CHMP and PRAC members on the Joint Assessment Report.
Day 103-106	When applicable, discussion at PRAC meeting.
Day 120	Discussion at CHMP (if applicable) - Adoption of CHMP opinion

For ATMP, the CAT Rapporteur will assess the renewal application together with the PRAC Rapporteur and will prepare a draft opinion for the CHMP as the basis for the CHMP's final opinion. Further information with regards to the CAT involvement is provided in the Procedural advice on the evaluation of advanced therapy medicinal product.

### **Re-examination**

Article 9(2) of Regulation (EC) No 726/2004 applies to CHMP Opinions adopted for renewal applications. The MAH may therefore notify the EMA/CHMP of their intention to request a re-examination of the opinion within 15 days of receipt of the opinion; if such a request is not made within these 15 days, the opinion becomes final.

The detailed grounds for the request must be forwarded to the EMA within 60 days of receipt of the opinion. If the MAH wishes to appear before the CHMP for an oral explanation, the request should also be sent at this stage.

A new CHMP Rapporteur, CAT Rapporteur as applicable, and a new PRAC Rapporteur, different from those for the initial opinion will be appointed to co-ordinate the re-examination procedure, accompanied, if necessary, by additional experts.

### **References**

- Guideline on the processing of renewals in the centralised procedure (EMA/CPMP/2990/00 Rev 5)

## **11.6. What fee do I have to pay for a renewal? *Rev. Dec 2015***

For information about fees and fee payment in the Centralised Procedure, please refer to the Explanatory note on fees payable to the European Medicines Agency.

In case an inspection is required, please note that in addition to the renewal fee, an inspection fee will be requested (see also Inspections website).

### **References**

- Fees payable to the European Medicines Agency

## **11.7. Can other non-renewal specific changes be included in the renewal application? *Rev. Dec 2015***

None of the changes introduced at renewal should substitute for the MAH's obligation to update the MA throughout the life of the product as data emerge.

Besides, major changes to the product, such as the introduction of a new indication and quality changes such as an extension of shelf life, should not be modified as part of the renewal procedure but have to be submitted and assessed through the appropriate variation procedure.

Where there are adequate and objective reasons not to renew the MA in its existing terms and changes are necessary to the SmPC, labelling and package leaflet arising from the renewal evaluation, the MAH may submit additional information and/or change the product information as part of the renewal process to address the concerns raised. Such changes will not initiate a separate variation procedure.

Other issues arising from assessment and changes due to the revision of the SmPC guideline, other relevant guidelines impacting on the product information, or EMA/QRD Product Information Templates should be considered within the renewal procedure.

The section "present/proposed" in the application form should clearly list any changes introduced to the product information (including any minor linguistic amendment introduced for each language). Alternatively, such listing may be provided as a separate document attached to the application form. Any changes not listed will not be considered as part of the renewal application.

## References

- Guideline on the processing of renewals in the centralised procedure (EMA/CPMP/2990/00 Rev. 5)

### ***11.8. How to handle other ongoing variation applications during the renewal procedure and what impact may ongoing procedures have on the renewal procedure? Rev. Dec 2015***

MAHs are advised to plan, when possible, the submission of variation applications outside the period of the submission of the renewal application and the renewal assessment procedure. However, where the need for a variation of the MA has been identified, in particular in the context of safety concerns, the MAH is advised to contact the Agency in advance of the submission of the variation application to agree on the procedural aspects for handling these parallel applications.

In case an ongoing variation (Type IA/IB or Type II) affecting the product information is not yet finalised at the time of the submission of the renewal application, the last product information adopted/accepted by the EC/CHMP/EMA should be used for the submission of the renewal application.

If a variation procedure is finalised before or upon finalisation of the renewal procedure, the accepted/adopted variation changes should be reflected in the product information adopted with the CHMP Renewal opinion.

In cases where any ongoing procedure may affect the product information, the MAH is advised to contact the Agency in advance of the submission or finalisation of the procedure(s) concerned.

### ***11.9. Do I have to submit mock-ups and specimens? Rev. Aug 2017***

The MAHs are reminded of the requirement to submit specimens at the time of the 5-year renewal application. These are to be submitted by post to the Agency.

For further information concerning submission of mock-ups and specimens in the framework of post-authorisation procedures, please refer to the document 'Checking process of mock-ups and specimens

of outer/immediate labelling and package leaflet of human medicinal products in the centralised procedure.

## References

- The checking process of mock-Ups and specimens of outer/immediate labelling and package leaflets of human medicinal products in the centralised procedure (EMA/305821/2006)

### **11.10. When do I have to submit revised product information? In all languages? Rev. Apr 2021**

Where no amendments to the product information are proposed by the MAH, only a copy of the latest approved product information (full set of Annexes, 'clean') in English must be submitted to the Agency in Word format.

In case the renewal application includes proposals for changes to the SmPC, Annex II, labelling and/or package leaflet, the product information must be submitted as follows:

#### **At submission**

English language (only): complete set of Annexes within the eCTD sequence and in Word format (both clean and highlighted showing the changes proposed as part of the Renewal).

If changes are approved as part of the Renewal, the following steps will apply:

#### **After CXMP Opinion (Day +5)**

All EU languages (incl. EN, NO and IS): complete set of annexes in Word format (highlighted)

#### **After Linguistic check (Day +25)**

All EU languages (incl. EN, NO and IS): complete set of annexes in Word format (highlighted) and in PDF (clean)

Translations of the adopted product information in all EU languages (incl. EN, NO and IS) are to be provided electronically (in one Eudralink package) to the Member States Contact Points for Translations by Day +5 with a copy to the EMA Procedure Assistant and to the EMA Product Shared Mailbox.

The 'full set of Annexes' consists of Annex I, II, IIIA, IIIB and, if applicable, IV and 127a as appropriate.

Annexes must be presented sequentially (i.e. Annex I, II, IIIA, IIIB, and if applicable, IV) as one Word document for each official EU language. Annex 127a (when applicable) must be presented as a separate PDF document with "127a" removed from the title page together with the Word files highlighted with tracked changes. All translations should be numbered as ONE document, starting with "1" (bottom, centre) on the title page of Annex I and Annex (127a) when applicable. The 'QRD Convention' published on the EMA website defines format and layout of the PI. The PDF user guide should also be followed as it provides guidance on how to correctly prepare the PDF versions. When submitting the full set of Annexes in PDF format, this should be accompanied by the completed Day +25 Checklist. Highlighted changes should be indicated via 'Tools – Track changes'. Clean versions should have all changes 'accepted'.

The revised Annex A, where applicable, is to be provided to the Agency as a separate Word document in all EU languages (see point 1.12 below) and in PDF (clean).

The Annexes provided should only reflect the changes introduced by the Renewal. However, in exceptional cases where MAHs take the opportunity to introduce minor linguistic amendments to the texts (e.g. further to a specimen check), this should be clearly mentioned in the cover letter.

In addition, the section “present/proposed” in the application form should clearly list the minor linguistic amendments introduced for each language.

Alternatively, such listing may be provided as a separate document attached to the application form. Any changes not listed will not be considered as part of the renewal application.

Please be reminded that in accordance with Union data protection requirements, no personal data should be included in the annotated product information annexes. This applies to the English version submitted at the time of opinion, the draft translations submitted at Day+5 and the final translations submitted at Day+25. Please submit annotated product information annexes in an anonymised format (i.e. names of the reviewers removed from the track-changes). If you do not wish to do so, please ensure that the individuals whose data is included consented to its sharing with EMA and its further sharing by EMA with third parties such as other marketing authorisation applicants, marketing authorisation holders and National Competent Authorities, as relevant. EMA expressly disclaims any liability or accountability for the presence of unnecessary personal data in the annotated product information annexes submitted by the marketing authorisation holder.

## References

- Guideline on the processing of renewals in the centralised procedure (EMEA/CPMP/2990/00 Rev. 5)
- The new Linguistic Review Process of Product Information in the Centralised Procedure (EMEA/5542/02 Rev. 5)

### **11.11. When will the linguistic checking of the product information take place? Rev. Apr 2021**

During the scientific renewal assessment, a detailed pre-opinion review of the English (EN) version of the product information will be performed by the Agency, the QRD (Quality Review Document) members and representatives of Patients’ and Consumers’ Organisations. Technical Labelling Review comments will be sent to the MAH by day 75. When providing a revised EN version for adoption of the opinion, applicants should inform the Agency if and why certain Technical Labelling Review comments are not taken into account.

Translations of the adopted product information in all other EU languages (including IS and NO) are to be provided electronically (in one Eudralink package) to the Member States Contact Points for Translations ( by Day +5 with a copy to the EMA Procedure Assistant and to the EMA Product Shared Mailbox.

The following **checks post-opinion** will apply:

Who	When	Scope
QRD/ ‘Member State’	Day +5 to +19	Detailed review of (highlighted changes in) all translations

EMA	Day +25 to +27	Review of implementation of Member States comments
-----	----------------	--

Comments will be sent directly by the Member States to the MAH at the latest by Day +19, with a copy to the EMA Product Shared Mailbox.

The MAH will send the final translations with tracked changes, incorporating the Member States' comments in Word format, as well as in PDF format (clean), electronically (in one Eudralink package) to the EMA Procedure Assistant with a copy to the EMA Product Shared Mailbox by Day +25. The Eudralink package should be presented in compliance with the Day +25 Checklist.

The Agency will check if all Member States' comments have been implemented before sending the final translations to the Commission. In order to facilitate and accelerate the check of the implementation of the Member States' comments, the applicant should indicate in QRD Form 2 for each language if all comments have been implemented or not. In the latter case, a justification as why certain comments are not reflected in the final texts should be provided for the appropriate language(s). Such justification(s) and/or alternative proposals should be discussed and agreed with the relevant Member State(s) **before** submitting final translations to the Agency.

In case the Renewal affects only the Annex II, no or a shorter post-opinion translation timetable may be considered by the Agency on a case-by-case basis.

Following receipt of the final translations from the EMA, the Commission will start the 22-day Standing Committee consultation, addressing only legal and public health matters (which means in principle no further linguistic review).

The Commission Decision on the renewal will be issued after consultation of the Standing Committee, by Day +67.

Please be reminded that in accordance with Union data protection requirements, no personal data should be included in the annotated product information annexes. This applies to the English version submitted at the time of opinion, the draft translations submitted at Day+5 and the final translations submitted at Day+25. Please submit annotated product information annexes in an anonymised format (i.e. names of the reviewers removed from the track-changes). If you do not wish to do so, please ensure that the individuals whose data is included consented to its sharing with EMA and its further sharing by EMA with third parties such as other marketing authorisation applicants, marketing authorisation holders and National Competent Authorities, as relevant. EMA expressly disclaims any liability or accountability for the presence of unnecessary personal data in the annotated product information annexes submitted by the marketing authorisation holder.

## References

- The new Linguistic Review Process of Product Information in the Centralised Procedure (EMA/5542/02 Rev. 5)
- SOP/EMA/0046: PIQ/QRD Pre-opinion Review of Product Information for Renewal Procedures
- Procedure for review of information on medicinal products by Patient's/Consumers Organisations (PCOs) (EMA/174255/2010 Rev. 2)
- SOP/EMA/0048: QRD Post-opinion Review of Product Information for post-authorisation procedures affecting the annexes, excluding Annex II applications.

### **11.12. What do I need to do if I do not want to renew the Marketing Authorisation of certain product presentations or the entire product? Rev. Feb 2019**

MAHs should only complete the renewal application form for those presentations which they would like to renew. In cases where the MAH does not wish to renew certain product presentations (e.g. a certain pharmaceutical form, strength or pack-size) this should be clearly indicated in the cover letter (see also "How shall I present my renewal application").

In case the MAH does not wish to renew the entire MA (i.e. all authorised presentations) a letter to this effect should be addressed to the rapporteur, Product Lead, EMA product shared mailbox and the contact point at the European Commission, at the latest 9 months prior to the expiry of the concerned MA, clearly stating the reasons for not requesting the renewal of the MA.

This is without prejudice of the MAH obligation to notify such action to the Agency according to the provisions set out in Article 14 (b) of Regulation (EU) No 726/2004. Please refer to the EMA questions and answers on Withdrawn product notification.

#### **References**

- Article 14(b) of Regulation (EC) No 726/2004
- Directive 2001/83/EC

### **11.13. Will there be any publication on the outcome of my renewal application? Rev. Dec 2015**

The EPAR (published on the EMA website) will be revised to implement the CHMP conclusions in relation to the renewal procedure.

Besides, the CHMP meeting highlights following each CHMP meeting give information in its Annex on opinions in relation to renewal applications. This information includes the invented name of the product, its INN and the name of the MAH.

In case of an unfavourable opinion, recommending the suspension or the non-renewal of the MA, a Question and Answer (Q&A) document will be published by the Agency. This will include information and reasons for such opinion. The information will be provided in lay language, so that it can be understandable for the general public.

#### **References**

- CHMP meeting highlights
- EPARs



**11.14. Who should I contact if I have a question when preparing my application and during the procedure? *Rev. Feb 2019***

If you cannot find the answer to your question in the Q&A when preparing your application or during the procedure, please contact the Product Lead responsible for your product.

## 12. Annual renewal of conditional marketing authorisations

### **12.1. How long is my conditional marketing authorisation valid? Rev. Feb 2019**

In accordance with Article 14-a of Regulation (EC) No 726/2004, a conditional marketing authorisation (MA) is valid for one year from the date of notification of the Commission Decision to the marketing authorisation holder (MAH), and is renewable, annually, upon application by the MAH.

The conditional MA validity period is expressed in Commission Decisions, as follows:

- Initial MA: by reference to the date of notification of the Commission Decision to the MAH. Notification dates of the Commission Decision are published in the Official Journal and can also be found for each product in the Union Register published by the European Commission.
- Renewal: By reference to the previous MA expiry date.

In order for a conditional marketing authorisation to remain valid, a renewal application has to be made annually (irrespective of whether the marketing authorisation is suspended).

The renewal decision will usually refer to the expiry date of the preceding marketing authorisation so that the renewed authorisation will be valid from the date of the previous expiry.

For further information on the 'conditional' marketing authorisations, see Q&A of the pre-submission procedural guidance question 'Could my application qualify for a conditional marketing authorisation?'

#### **References**

- Article 14-a of Regulation (EC) No 726/2004
- Commission Regulation (EC) No 507/2006

### **12.2. When shall I submit my annual renewal application? Rev. Mar 2016**

According to the legislation, MAHs must apply for an annual renewal at least six months before the expiry date of the conditional MA.

In case a MAH does not submit a renewal application, the conditional MA will expire automatically.

Once a renewal application has been submitted within this deadline, the conditional marketing authorisation shall remain valid until a decision is adopted by the Commission in accordance with Article 10 of Regulation (EC) No 726/2004.

In order to ensure that the Commission Decision on the renewal application can be issued ideally before expiry of the conditional MA, MAHs should take into account the following principles when planning for their renewal submission:

- The annual renewal application must be submitted at least 6 months before the MA expiry date. A submission of the annual renewal application more than 1 month in advance of the submission due date will not be accepted by the Agency.
- The start of the evaluation process will be the nearest possible starting date, as published by the EMA in the "Human Medicines – Procedural Timetables / Submission dates").

- The CHMP assessment process can take up to 90 days.
- The Decision-Making Process (incl. Standing Committee consultation) for renewal procedures is 67 days.

In addition, as the quality of the annual renewal application will be key to ensure a timely start and finalisation of the annual renewal procedure, a pre-submission dialogue between MAHs and the Agency may be considered, approximately nine months in advance of MA expiry.

## References

- Article 6 of Commission Regulation (EC) No 507/2006
- Union Register of medicinal product: website of the European Commission

### **12.3. How shall I present my annual renewal application? *Rev. May 2020***

In order to allow the CHMP to confirm the benefit-risk balance of the medicinal product and to review the specific obligations and their timeframes for completion, annual renewal applications should be presented as indicated below, in accordance with the appropriate headings and numbering of the EU-eCTD format.

In order to ensure that annual renewal applications are complete and correct before submitting them to the Agency, it is strongly recommended to use the pre-submission checklist for annual renewal of conditional marketing authorisation applications.

## Module 1

### **1.0 Cover letter<sup>3</sup> with the following documents attached**

- List of all authorised product presentations for which renewal is sought in tabular format (following the template for Annex A to CHMP Opinion)

**Note:** In cases where the MAH does not wish to renew certain product presentations (e.g. a certain pharmaceutical form, strength or pack-size), this should be clearly indicated in the cover letter and they should not be included in the appended list.

- Chronological summary table of the Specific obligations (SOBs) and other conditions to the MA stating the following for each: description (scope), reference number (preferably SIAMED number), due date indicated in Annex II of the Product Information, date of submission and procedure within which the SOB was submitted (if appropriate), date when the obligation or condition has been resolved (if applicable), and the current status.
- A present/proposed table listing any changes introduced to the product information (incl. any minor linguistic amendment introduced for each language), if applicable
- Advice provided by the Pre-submission query service and or Product Lead, if applicable

---

<sup>3</sup> Please note that there is no application form available for annual renewals and that the application form for standard 5-year renewals available on the eSubmission website is not applicable to annual renewals of conditional marketing authorisations and therefore cannot be used

The submission should also contain a duly completed eSubmission delivery file in order to facilitate registration of the submission.

**Note:** The Cover Letter should be signed by the person designated as MAH contact with the EMA. The Annual Renewal application is not an opportunity to notify the Agency of changes in contact person, which should be notified separately. More information is available on 'Contacting EMA: post-authorisation'.

### **1.3 Product Information (PI)**

#### **1.3.1 Summary of Product Characteristics, Labelling and Package Leaflet**

- If no changes to the PI (SmPC, Annex II, outer/ inner labelling and Package Leaflet) are proposed by the MAH clear reference to it should be made in the cover letter. In addition, a 'clean' version of the latest PI in English has to be provided in Word format.
- If changes to the PI are proposed as part of the Annual Renewal dossier, a version of the PI in English, highlighting the changes proposed by the MAH should be provided in the eCTD and in Word format. In addition, a 'clean' version of the PI should be provided as Word format.

**Note:** All other language versions are only to be submitted after adoption of the opinion (See also "When do I have to submit revised product information? In all languages?").

The Annexes submitted should only reflect the changes introduced by the Annual Renewal data. Any updates to the product information not resulting from data submitted as part of the Annual Renewal should be submitted by use of the appropriate procedure (see question 1.7). However, minor linguistic amendments to the texts could be accepted in addition to changes introduced based on the annual renewal data, but this should be clearly mentioned in the cover letter and list of such changes provided as an attachment to the cover letter.

### **1.4 Information about the Expert**

**1.4.1** Information about the Expert – Quality (incl. signature + CV) – if applicable

**1.4.2** Information about the Expert – Non-Clinical (incl. signature + CV) – if applicable

**1.4.3** Information about the Expert – Clinical (incl. Signature + CV)

#### **1.8.2 Risk Management Plan**

An RMP is not systematically required as part of the Annual renewal application. Two scenarios are possible:

- Where no update to the RMP is to be implemented, an RMP update should not be included in the annual renewal submission. In this case, the MAH should specify this in the cover letter and declare in the clinical overview that the current approved RMP does not require changes. Alternatively, if applicable, the MAH can state that an RMP update is being assessed in a procedure ongoing in parallel and no additional RMP changes are considered warranted.
- If an update of the RMP is proposed by the MAH with the annual renewal application, section 1.8.2 should contain the updated RMP ('clean' version). In this case, a version of the RMP, highlighting the changes proposed by the MAH should be provided in Word format.

## **Module 2**

### **2.3 Addendum to Quality Overall Summary**

An Addendum to the Quality Overview is not systematically required as part of the annual renewal application. It should be provided only in case important new pharmaceutical data are available.

#### **2.4 Addendum to Non-Clinical Overview**

An Addendum to the Non-clinical Overview is not systematically required as part of the annual renewal application. It should be provided only in case important new non-clinical data are available.

#### **2.5 Addendum to Clinical Overview**

A critical discussion should be provided within the Addendum to the Clinical Overview. It should address the current benefit/risk balance for the product on the basis of the data generated in SOBs and taking into account any other safety/efficacy data (including PSUR data) accumulated since the granting of the MA.

An **Interim Report** on the specific obligations should be included in a separate section in the clinical overview addendum, reflecting the situation as close as possible to the submission date. The interim report on the fulfilment of the specific obligations should include details for each specific obligation. The aim of this report is to inform about the status of fulfilment of specific obligations and the impact of data generated on the benefit risk-balance of the product. If data from a specific obligation is due at the time of annual renewal submission and have not been yet submitted, it can be included in the annual renewal submission dossier. Final reporting of clinical trials should follow the conventional format of study reports (see ICH Topic E3 Note for guidance on structure and content of clinical study reports, CHMP/ICH/137/95). Clinical Summaries and Clinical Study Reports should not be included in section 2.5, but in the respective dedicated eCTD Sections, see below. One single report should be submitted for the product including all remaining specific obligations. The structure and contents of the interim report will vary depending on the type of study and available data. For further guidance on the contents of interim report on the specific obligations, please refer to the CHMP Guideline on the scientific application and the practical arrangements necessary to implement Commission Regulation (EC) No 507/2006 on the conditional marketing authorisation for medicinal products for human use falling within the scope of Regulation (EC) No 726/2004.

#### **2.7 Clinical Summaries**

Clinical summaries will generally need to be updated, as appropriate, when new clinical study reports are submitted.

### **Module 5**

**5.3.5 Reports of Efficacy and Safety Studies (as appropriate)** submitted to fulfil SOBs:

5.3.5.1 Study Reports of Controlled Clinical Studies Pertinent to the Claimed Indication

5.3.5.2 Study Reports of Uncontrolled Clinical Studies

5.3.5.3 Reports of Analyses of Data from More Than One Study

5.3.5.4 Other Clinical Study Reports

#### **12.4. How and to whom shall I submit my annual renewal application? Rev. Feb 2019**

**How:** The requirements for the submission of applications related to the centralised procedure are provided on the EMA website. Information is available on 'Submitting a post-authorisation application'.

**To whom:** To the EMA, CHMP, PRAC and CAT (when involved) members, submissions via the Common Repository only.

#### **12.5. How shall my annual renewal application be handled (timetable)? Rev. Mar 2016**

The MAH should submit the annual renewal application by the recommended submission dates published on the EMA website and, in any case, no later than 6 months before the MA ceases to be valid.

The Agency will acknowledge receipt of a valid annual renewal application and shall start the procedure in accordance with the recommended starting dates published on the EMA website. The MAH will be informed of the adopted timetable at the start of the procedure.

The timetable for the scientific evaluation by the CHMP will be set in order to ideally allow the Commission Decision to be adopted before the expiry date of the marketing authorisation.

Full procedural detailed timetables are published as a generic calendar on the EMA website (see: submission deadlines and full procedural timetables).

The published timetables identify the start and finish dates of the procedures as well as other interim dates/milestones that occur during the procedure.

The renewal procedure will involve the CHMP Rapporteur as well as the PRAC Rapporteur who have been appointed for the medicinal product. In case of an advanced therapy medicinal product additional steps will be included to accommodate the lead assessment by Committee for Advanced Therapies.

DAY	ACTION
D 1	Start of procedure
D 30	CHMP and PRAC Rapporteurs' joint assessment report
D 35	Comments from PRAC and CHMP members
D 39	Updated CHMP and PRAC Rapporteurs' joint assessment report
D 46	PRAC outcome
D 60	Adoption of CHMP opinion and CHMP assessment report (or request for supplementary information without a clock stop)
D 66	Submission of responses to request for supplementary information
D 75	CHMP and PRAC Rapporteurs' joint assessment report
D 76	PRAC outcome

DAY	ACTION
D 80	Comments from CHMP members
D 83	Updated CHMP and PRAC Rapporteurs' joint assessment report
D 90	Adoption of the CHMP Opinion

### **12.6. What fee do I have to pay for a renewal? *NEW Mar 2013***

There is no fee payable for the annual renewal of a conditional marketing authorisation.

#### **References**

- Fees payable to the European Medicines Agency

### **12.7. Can other non-renewal specific changes be included in the annual renewal application? *Rev. Mar 2016***

None of the changes introduced at renewal should substitute for the MAH's obligation to update the marketing authorisation throughout the life of the product as data emerge.

In particular major changes to the product, such as the introduction of a new indication and quality changes such as an extension of shelf life, should not be modified through the annual renewal procedure but have to be submitted and assessed through the appropriate variation procedure.

Where there are adequate and objective reasons not to renew the marketing authorisation in its existing terms and changes are necessary to the SmPC, labelling and package leaflet arising from the renewal evaluation, the Marketing Authorisation Holder may submit additional information and/or change the product information as part of the annual renewal process to address the concerns raised. Such changes will not require a separate variation procedure.

Other issues arising from assessment of data required for the annual renewal and changes due to the revision of the product information in line with SmPC guideline, other relevant guidelines, or EMA/QRD Product Information Templates can be considered within the annual renewal procedure.

A present/proposed table clearly listing any changes introduced to the product information (incl. any minor linguistic amendment introduced for each language) should be attached to the cover letter.

### **12.8. How to handle other ongoing variation applications during the renewal procedure and what impact may ongoing procedures have on the renewal procedure? *Rev. Mar 2016***

Although MAHs are advised to avoid other procedures at the time of annual renewal, such situations cannot be excluded.

In case that an ongoing variation (Type IA/IB or Type II) affects the product information and is not yet finalised at the time of the submission of the annual renewal application, the last product information

adopted/accepted by the EC/CHMP/EMA should be used in the submission of the annual renewal application.

If the variation procedure is finalised before or upon finalisation of the annual renewal procedure, the accepted/adopted variation changes should be reflected in the annual renewal product information.

In cases where any other ongoing procedure may affect the product information, the MAH is advised to contact the Agency in advance of the submission or finalisation of the procedure(s) concerned.

### **12.9. Do I have to submit mock-ups and specimens? Rev. Mar 2016**

No mock-ups or specimens are required for the annual renewal of a conditional marketing authorisation. For details of when to submit mock-ups and specimens in the post-authorisation phase of your medicinal product, please refer to the revised checking process of mock-up and specimens information on the EMA web.

#### **References**

- Checking process of mock-ups and specimens of outer/immediate labelling and package leaflet of human medicinal products in the centralised procedure (EMA/305821/2006/Rev. 2).

### **12.10. When do I have to submit revised product information? In all languages? Rev. Apr 2021**

In case the renewal application affects SmPC, Annex II, labelling and/or package leaflet, the revised product information Annexes must be submitted as follows:

#### **At submission**

Language	
EN (only)	- As part of the eCTD - Word format (highlighted and clean)

English language (only): complete set of Annexes within the eCTD sequence and in Word format (clean and highlighted showing the changes proposed as part of the Annual Renewal).

Where no amendments to the product information are proposed by the MAH, only an electronic copy of the latest approved product information (full set of Annexes, 'clean') in English must be submitted to the Agency in Word format.

If changes are approved as part of the Annual Renewal, the following steps will apply:

#### **After CHMP Opinion (Day +5)**

In case the annual renewal results in changes to the SmPC, Annex II, labelling and/or package leaflet, the revised complete set of Annexes must be submitted as follows:



Language	
All EU languages (incl. EN, NO and IS)	Via Eudralink - Word format (highlighted)

All EU languages (incl. EN, NO and IS): complete set of Annexes in Word format (highlighted)

### After Linguistic check (Day +25)

In case the annual renewal results in changes to the SmPC, Annex II, labelling and/or package leaflet, the revised complete set of Annexes must be submitted as follows:

Language	
All EU languages (incl. EN, NO and IS)	Via Eudralink - Word format (highlighted) - PDF format (clean)

All EU languages (incl. EN, NO and IS): complete set of Annexes in Word format (highlighted) and in PDF (clean)

Translations of the adopted product information in all EU languages (including English, Icelandic and Norwegian) are to be provided electronically (in one Eudralink package) to the Member States Contact Points for Translations by Day +5 with a copy to the EMA Product Shared Mailbox.

The revised Annex A, where applicable, is to be provided to the Agency as a separate word document in all EU languages (see point 1.12 below) and in pdf (clean).

Please be reminded that in accordance with Union data protection requirements, no personal data should be included in the annotated product information annexes. This applies to the English version submitted at the time of opinion, the draft translations submitted at Day +5 and the final translations submitted at Day +25. Please submit annotated product information annexes in an anonymised format (i.e. names of the reviewers removed from the track-changes). If you do not wish to do so, please ensure that the individuals whose data is included consented to its sharing with EMA and its further sharing by EMA with third parties such as other marketing authorisation applicants, marketing authorisation holders and National Competent Authorities, as relevant. EMA expressly disclaims any liability or accountability for the presence of unnecessary personal data in the annotated product information annexes submitted by the marketing authorisation holder.

### References

- Guideline on the processing of renewals in the centralised procedure (EMEA/CPMP/2990/00 Rev. 4)
- The new Linguistic Review Process of Product Information in the Centralised Procedure (EMEA/5542/02 Rev. 4.2)

### **12.11. When will the linguistic checking of the product information take place? Rev. Apr 2021**

Translations of the adopted product information in all other EU languages (Including Icelandic and Norwegian) are to be provided electronically (in one Eudralink package) to the Member States Contact

Points for Translations (list of members states contact points for translation) by Day +5 and copied to the EMA Procedure Assistant.

The following **checks post-opinion** will apply:

Check by	When	Who	Scope
QRD/ 'Member State'	Day +5 to +19	Member States	Detailed review of (highlighted changes in) all translations
PIQ	Day +25 to +27	EMA	Review of implementation of Member States comments

Comments will be sent directly by the Member States to the MAH at the latest by Day +19, with a copy to the EMA Procedure Assistant.

The MAH will send the final translations with tracked changes, incorporating the Member States' comments, electronically to the Product Lead secretary by Day +25.

The Agency will check if all Member States' comments have been implemented before sending the final translations to the Commission. In order to facilitate and accelerate the check of the implementation of the Member States' comments, the applicant should indicate in QRD Form 2 for each language if all comments have been implemented or not. In the latter case, a justification should be provided for the appropriate language(s) stating why certain comments are not reflected in the final texts.

In case the Renewal affects only the Annex II, no or a shorter post-opinion translation timetable may be considered by the Agency on a case-by-case basis.

Following receipt of the final translations from the EMA, the Commission will start the 22-day Standing Committee consultation, addressing only legal and public health matters (which means in principle no further linguistic review).

The Commission Decision on the renewal will be issued after consultation of the Standing Committee, by Day +67.

Please be reminded that in accordance with Union data protection requirements, no personal data should be included in the annotated product information annexes. This applies to the English version submitted at the time of opinion, the draft translations submitted at Day +5 and the final translations submitted at Day +25. Please submit annotated product information annexes in an anonymised format (i.e. names of the reviewers removed from the track-changes). If you do not wish to do so, please ensure that the individuals whose data is included consented to its sharing with EMA and its further sharing by EMA with third parties such as other marketing authorisation applicants, marketing authorisation holders and National Competent Authorities, as relevant. EMA expressly disclaims any liability or accountability for the presence of unnecessary personal data in the annotated product information annexes submitted by the marketing authorisation holder.

## References

- The new Linguistic Review Process of Product Information in the Centralised Procedure (EMA/5542/02 Rev. 4.2)
- SOP/EMA/0046: PIQ/QRD Pre-opinion Review of Product Information for Renewal Procedures

- Procedure for review of information on medicinal products by Patient's/Consumers Organisations (PCOs) (EMA/174255/2010 Rev. 2)
- SOP/EMEA/0048: QRD Post-opinion Review of Product Information for Renewal Applications, Annual Reassessments, Type II Variations (60/90 Days) and Referrals

**12.12. What do I need to do if I do not want to renew the Marketing authorisation of certain product presentations or the entire product? Rev. Mar 2016**

In cases where the MAH does not wish to renew certain product presentations (e.g. a certain pharmaceutical form, strength or pack-size) this should be clearly indicated in the cover letter (See also "How shall I present my renewal application").

In case the MAH does not wish to renew the entire Marketing Authorisation (i.e. all presentations) a letter to this effect should be addressed to the Agency and the European Commission at the latest 6 months prior to the expiry of the concerned Marketing Authorisation, clearly and in detail stating if the marketing authorisation is surrendered for any reasons beyond purely commercial ones.

This is without prejudice of the MAH obligation to notify such action to the Agency according to the provisions set out in Article 14 (b) of Regulation (EU) No 726/2004. Please refer to the EMA questions and answers on Withdrawn product notification.

**References**

- Article 14(b) of Regulation (EC) No 726/2004
- Directive 2001/83/EC

**12.13. What do I need to do if all Specific Obligations have been completed? Rev. Feb 2019**

Once the specific obligations have been fulfilled, the Committee may, following an application by the marketing authorisation holder, at any time adopt a recommendation for the granting of a marketing authorisation no longer subject to specific obligations and valid for five years. MAHs who consider that all Specific Obligations have been fulfilled should indicate this in the cover letter of the submission, in which final data from the last outstanding specific obligation is being submitted. This could be either within an annual renewal application or a variation, whichever is appropriate.

**References**

- Article 14-a(8) of Regulation (EC) No 726/2004
- Article 7 of Commission Regulation (EC) No 507/2006

### **12.14. Will there be any publication on the outcome of my annual renewal application? *Rev. Mar 2016***

The EPAR (published on the EMA website) will be revised to implement the CHMP conclusions in relation to the renewal procedure.

Besides, the CHMP meeting highlights following each CHMP meeting gives information in its Annex on opinions in relation to renewal applications.

In case of an unfavourable opinion, recommending suspension or non-renewal of the MA, a Question and Answer (Q&A) document will be published by the Agency. This will include information and reasons for such an opinion. The information will be provided in lay language, so that it can be understandable for the general public.

#### **References**

- CHMP meeting highlights
- EPARs

### **12.15. Who should I contact if I have a question when preparing my application? *Rev. Feb 2019***

If you cannot find the answer to your question in the Q&A when preparing your application or during the procedure, please contact the Product Lead responsible for your product.

## 13. Post Authorisation Safety Study (PASS)

### 13.1. What is a non-interventional imposed PASS? **NEW Jul 2017**

A post-authorisation safety study (PASS) is defined in Article 1(15) of Directive 2001/83/EC as “any study relating to an authorised medicinal product conducted with the aim of identifying, characterising or quantifying a safety hazard, confirming the safety profile of the medicinal product, or of measuring the effectiveness of risk management measures”.

A PASS is non-interventional if:

- the medicine is prescribed in the usual way in accordance with the terms of the marketing authorisation;
- deciding how to treat the patient is based on current practice and not a trial protocol;
- the prescription of the medicine is clearly separated from the decision to include the patient in the study;
- patients do not undergo additional diagnostic or monitoring procedures;
- data analysis uses epidemiological methods<sup>4</sup>.

An EU competent authority may impose a non-interventional PASS, either as a condition of marketing authorisation (category 1) at the moment of granting the marketing authorisation or in the post-authorisation phase, or as a specific obligation in a conditional marketing authorisation or a marketing authorisation under exceptional circumstances (category 2). For more information, please refer to the good pharmacovigilance practices (GVP) Module VIII- Post-authorisation Safety Studies.

#### References

- Directive 2001/83/EC
- Regulation (EC) No 726/2004
- GVP Module VIII - Post-authorisation safety studies

### 13.2. Under which procedure should I submit my non-interventional imposed PASS? **Rev. Apr 2021**

The rules governing non-interventional imposed PASS are set in Articles 107n-q of Directive 2001/83/EC.

Non-interventional imposed PASS will be assessed by the Pharmacovigilance Risk Assessment Committee (PRAC), except for studies to be conducted in only one Member State requesting the study according to Article 22a of Directive 2001/83/EC. Such studies should be submitted to the National Competent Authority (NCA) of the Member State in which the study is conducted, who will perform the assessment nationally.

---

<sup>4</sup> Systematic reviews and meta-analyses of safety data should be considered as non-interventional PASS.

The requirements for submission and assessment of protocols and final study reports for non-interventional imposed PASS:

### **13.2.1. Draft Protocols – Article 107n procedure**

Before a non-interventional imposed PASS is conducted, the marketing authorisation holder(s) (MAH(s)) have to submit a draft protocol for review and endorsement by PRAC.

### **13.2.2. Substantial amendments of an agreed protocol – Article 107o procedure**

After a study has commenced, the MAH has to submit any substantial amendment to the protocol, before its implementation, for review and endorsement by PRAC.

Amendments are considered substantial when the changes proposed are likely to have an impact on the safety, physical or mental well-being of the study participants or that may affect the study results and their interpretation, such as changes to the primary or secondary objectives of the study, the study population, the sample size, the study design, the data sources, the method of data collection, the definitions of the main exposure, outcome and confounding variables or the statistical analytical plan as described in the study protocol.

Changes in the milestones affecting the timelines for the submission of the final study reports should be considered as substantial amendments to the protocol and should consequently be submitted for assessment to the PRAC as an Article 107o procedure. Following the assessment and conclusion of the procedure, outcomes endorsing changes to the timelines on the submission of such final study results will be made public on the dedicated EMA webpage on PASS outcomes.

For centrally authorised medicinal products (CAPs) the change of the due date of the corresponding condition to the marketing authorisation (MA) will require a change to Annex II of the marketing authorisation via a variation application.

### **13.2.3. Final study results – Article 107q procedure**

Upon completion of the study, the MAH has to submit a final study report within 12 months of the end of data collection to the PRAC (Article 107p of Directive 2001/83/EC).

Based on the results of the study and after consultation with the MAH(s), the PRAC may make recommendations concerning the marketing authorisation.

Importantly, only study reports that are considered final by the MAH(s) should be submitted to the Agency. For this purpose, the definitions included in Article 37(2) of Commission Implementing Regulation (EC) No 520/2012 ("*End of data collection means the date from which the analytical dataset is completely available*") and GVP Module VIII ("*Analytical dataset: the minimum set of data required to perform the statistical analyses leading to the results for the primary objective(s) of the study*" – Section VIII.A.1. Terminology) should be applied.

In cases where the analytical dataset is not complete and/or further data are still being collected by the MAH(s), the Agency should be contacted prior to submitting the final study report.

Interim results and/or feasibility studies of non-interventional imposed PASS do not fall under the provisions in Articles 107n-q of Directive 2001/83/EC. When those are requested to be submitted, appropriate procedures should be followed (i.e. submission to NCA for nationally authorised products

or to EMA for centrally authorised products refer to question on 'When and how should study progress reports and interim results be submitted?').

#### References

- Directive 2001/83/EC
- Regulation (EC) No 726/2004
- Commission Implementing Regulation (EC) No 520/2012
- GVP Module VIII - Post-authorisation safety studies

### **13.3. What if the results of a non-interventional imposed PASS make a variation necessary? *NEW Jul 2017***

The results of non-interventional imposed PASS should be evaluated by the MAH(s), who should consider whether the results have an impact on the marketing authorisation. If the MAH(s) concludes that this is indeed the case, the MAH(s) should submit the results directly as an application for variation to the relevant competent authority.

Independently of the MAH(s) evaluation of the need for a variation, and following the assessment of the final study report, the PRAC may issue a recommendation to the Committee for Medicinal Products for Human Use (CHMP) for any regulatory action that is deemed to be appropriate.

#### References

- Directive 2001/83/EC
- Regulation (EC) No 726/2004

### **13.4. How shall I present my non-interventional imposed PASS and in which format? *Rev. May 2020***

The format of non-interventional imposed PASS protocols and final study reports (Articles 107n-q of Directive 2001/83/EC) is provided in Annex III of Commission Implementing Regulation (EC) No 520/2012.

Further guidance is provided in GVP Module VIII and in the EMA Guidance for the format and content of the protocols and the final study reports of non-interventional post-authorisation safety studies.

#### **13.4.1. Protocols and protocol amendments (Articles 107n-o)**

Draft protocols of non-interventional imposed PASS should be submitted as a separate document in module 1.8.2 of the common technical document (CTD). They should only be included as an annex to the risk management plan (RMP), once they are endorsed by PRAC, at the next regulatory opportunity.

In case national variants of a study protocol are necessary to ensure the appropriate implementation of the study requirements to the specificities of national law, they should be submitted in the form of a regional appendix to the main protocol.

### 13.4.2. Final study results (Article 107q)

Imposed non-interventional PASS final study reports should be submitted in module 5.3.6 of the CTD.

Proposed changes to the product information as a result of the data within the PASS final study report can be submitted as part of the Article 107q procedure. The revised product information of the product(s) concerned should be presented in English language in module 1.3.

Where the proposed changes are not based on the data submitted within the final study report, these will not be considered and a variation will have to be submitted as appropriate to the relevant national competent authority.

A RMP update can also be submitted with a final PASS study report for single centrally authorised medicinal product or a mixture of CAPs belonging to the same global marketing authorisation (GMA) when the changes to the RMP are a direct result of data presented in the study report. In this case no stand-alone RMP variation is necessary. If the above does not apply, the updated RMP should be submitted as a stand-alone variation.

The submission should include a cover letter and in order to facilitate the registration of the submission, the eSubmission delivery file should be duly completed as required for the procedure. For joint studies, the contact point of the marketing authorisation holders or consortium may be contacted for financial purposes.

#### References

- Directive 2001/83/EC
- Commission Implementing Regulation (EC) No 520/2012
- GVP Module VIII - Post-authorisation safety studies
- Guidance for the format and content of the protocol of non-interventional post-authorisation safety studies
- Guidance for the format and content of the final study result of non-interventional post-authorisation safety studies

### **13.5. To whom should I submit my imposed non-interventional PASS? *Rev. May 2020***

The following requirements are related to the non-interventional imposed PASS protocols and final study report which are supervised by the PRAC.

- for CAPs and NAPs: to be submitted to EMA in eCTD format only via the eSubmission Gateway or eSubmission Web Client (as per Dossier requirements for centrally authorised products (CAPs) and Dossier requirements for NAPs (referral, PASS107, worksharing, signal detection procedures and ancillary medicinal substances in medical devices).

All submission for CAPs and NAPs sent to EMA via eSubmission Gateway/Web Client will be considered delivered to the PRAC Rapporteur and all members of the PRAC.



Any additional copies should not be submitted directly to the NCAs on CD/DVD or via CESP as this might lead to validation issues and cause delays. All centralised procedure submissions should be made via EMA eSubmission Gateway/Web Client only.

Any response to a request for supplementary information must be sent to EMA, the PRAC Rapporteur and all PRAC members as per above requirements.

All submissions should contain a cover letter and a duly completed eSubmission delivery file.

More information is available on 'Submitting a post-authorisation application'.

## References

- Dossier requirements for centrally authorised products (CAPs)
- Dossier requirements for referral, ASMF and NAP submissions (PASS107, workshare, signal detection procedures) and ancillary medicinal substances in a medical device.
- eSubmission website
- Harmonised guidance for eCTD submissions in the EU

### **13.6. How do I submit a joint PASS? Rev. May 2020**

If the same safety concerns apply to more than one medicinal product, the relevant competent authority shall, following consultation with the PRAC, encourage the MAHs concerned to conduct a joint PASS (Article 10a(1)(a) of Regulation (EC) No 726/2004, Article 22a(1)(a) of Directive 2001/83/EC).

At the time of imposition of the study by the PRAC, EMA will support interactions between the MAHs concerned by sharing contact details among those that wish to participate in a joint study. A dedicated meeting with the PRAC Rapporteurs may be organised to support interactions between the MAHs and to provide suggestions for the joint study proposal.

Submissions of joint PASS follow the same requirements as single studies. A single contact person for the submission should be appointed amongst all MAHs concerned and specified in the cover letter. This person will be the primary contact point on all interactions with EMA and will receive the documentation relevant for the procedure. The responsibility to communicate with the rest of the participants in the joint study lies with the appointed contact person as per the specific contractual arrangements among MAHs.

For joint studies it is of particular importance to accurately reflect in the cover letter the full list of medicinal products and MAHs concerned by the joint study (the eSubmission delivery file should list all the concerned medicinal products), as this will define the scope of the procedure, directly affecting the calculation of fees payable to EMA.

## References

- Directive 2001/83/EC
- Regulation (EC) No 726/2004
- GVP Module VIII - Post-authorisation safety studies

## ***13.7. How will my non-interventional imposed PASS protocol be handled?*** **Rev. Feb 2019**

### **13.7.1. Submission**

Upon receipt of a technically valid application, the Risk Management Specialist (RMS) will perform the validation of the initial application (including format of the protocol). Supplementary information may be requested by the RMS in order to finalise the validation. The procedure will commence at the next available start date after all validation issues have been resolved. The Agency will inform the MAH of the outcome of the validation, the procedure number and procedural timetable.

For NAPs, a PRAC Rapporteur will be appointed upon receipt of a PASS protocol. The name of the appointed PRAC Rapporteur will be communicated to the marketing authorisation holder by EMA at the start of procedure. For CAPs, the PRAC Rapporteur will be the one already appointed for the product.

### **13.7.2. Assessment**

The assessment under a 107n procedure is as follows, regardless whether it refers to one or more centrally authorised medicinal products, a mix of centrally authorised medicinal products and nationally authorised products, or nationally authorised products only.

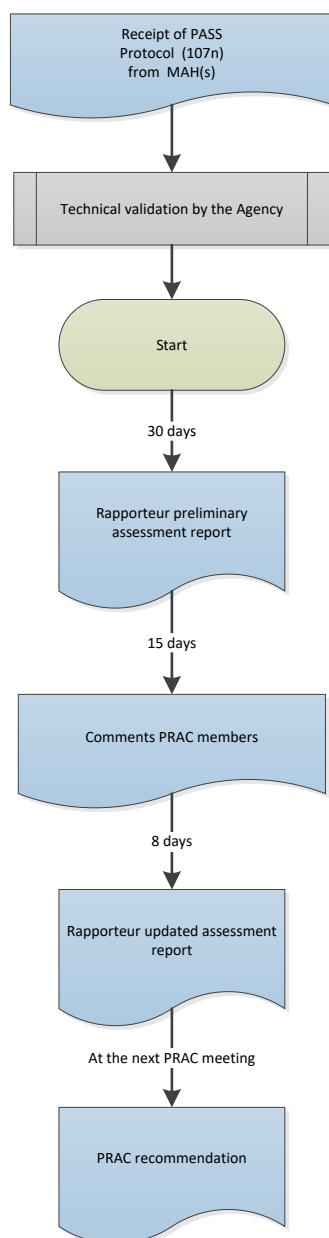

The assessment of a non-interventional imposed PASS protocol is performed by the PRAC. The timelines for assessment are 60 days, the following timetable shall apply:

Day	Action
Day 0	Start of the procedure according to the published timetable
Day 30	PRAC Rapporteur's preliminary assessment report
Day 45	PRAC members' comments
Day 53	PRAC Rapporteur's updated assessment report (if necessary)

The outcome is a legally binding PRAC letter to the MAH(s) with the following options:

- a letter notifying the MAH that the study is a clinical trial falling under the scope of Directive 2001/20/EC;
- a letter of objection specifying the grounds of objection and the timelines for resubmission and reassessment of the protocol;
- a letter of endorsement of the draft protocol.

In the instances when PRAC adopts a letter of objection, submission of an amended protocol will be required usually within 60 days (which could be shortened or extended depending on the revisions). The revised protocol can then follow subsequent 60-day assessment procedures as per the timelines above until it is fully endorsed by the PRAC.

### References

- Directive 2001/83/EC
- Regulation (EC) No 726/2004
- Commission Implementing Regulation (EC) No 520/2012
- GVP Module VIII - Post-authorisation safety studies
- Timetables for non-interventional imposed PASS protocols and results

## **13.8. How will my imposed non-interventional PASS final study report be handled? *Rev. Feb 2019***

### **13.8.1. Submission**

Upon receipt of a technically valid application, The Risk Management Specialist (RMS) will perform the validation of the application content. Supplementary information may be requested by the RMS in order to finalise the validation. The procedure will commence at the next available start date after all validation issues have been resolved. The Agency will inform the MAH of the outcome of the validation and procedural timetable.

For NAPs, a PRAC Rapporteur will be appointed upon receipt of a PASS final study report. The name of the appointed PRAC Rapporteur will be communicated to the marketing authorisation holder by EMA at the start of procedure. For CAPs, the PRAC Rapporteur will be the one already appointed for the product.

### **13.8.2. Assessment**

The assessment under a 107q procedure is as follows, regardless whether it refers to one or more centrally authorised medicinal products, a mix of centrally authorised medicinal products and nationally authorised products, or nationally authorised products only.

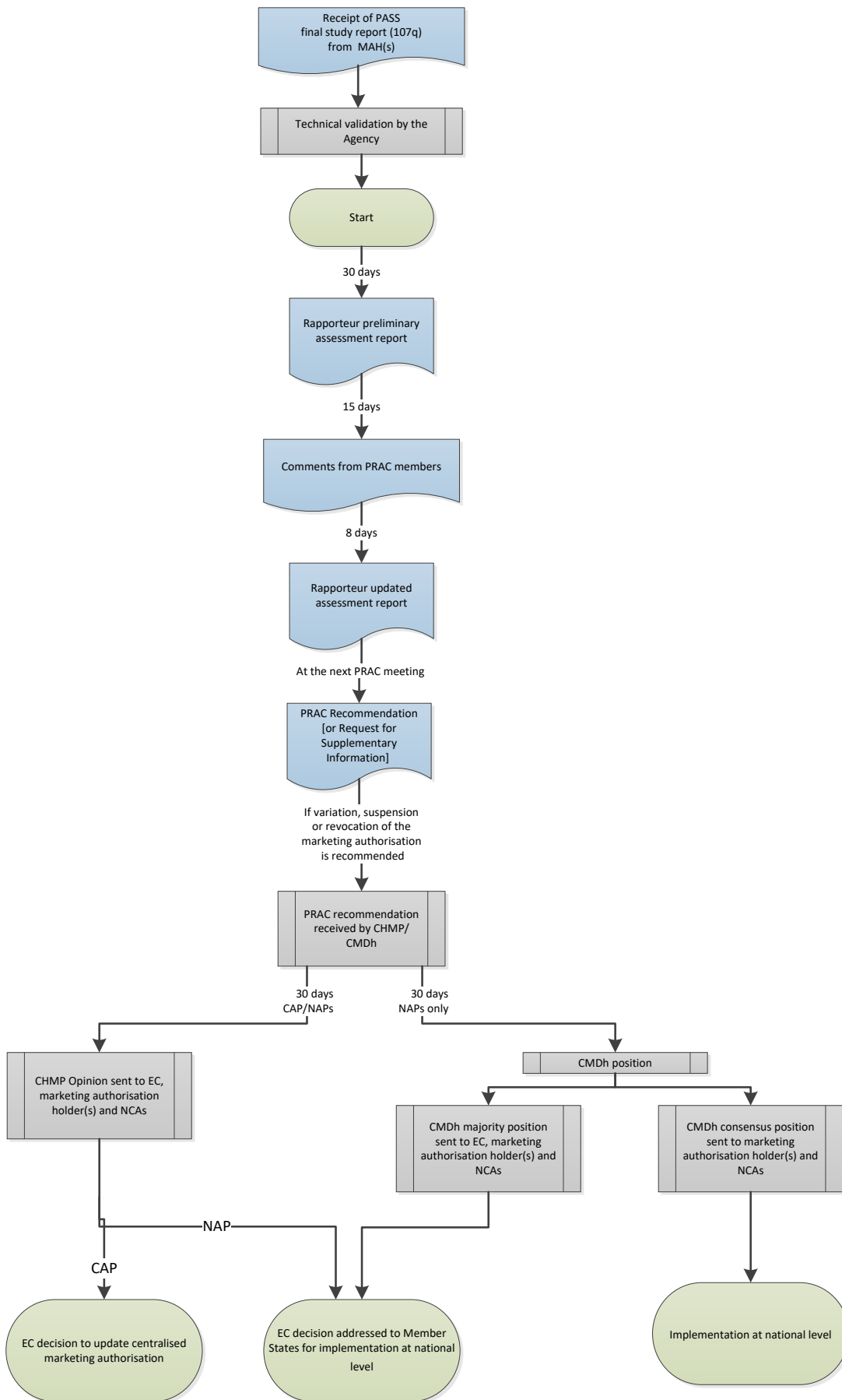

The assessment of a non-interventional imposed PASS final study report is performed by the PRAC. The timelines for assessment are for up to 74 days followed by 67 days of European Commission (EC) decision making process (if applicable).

<b>Day</b>	<b>Action</b>
Day 0	Start of the procedure according to the published timetable
Day 30	PRAC Rapporteur's preliminary assessment report
Day 45	PRAC members' comments
Day 53	PRAC Rapporteur's updated assessment report (if necessary)
Day 60	PRAC Recommendation [or Request for Supplementary Information]
Day 74	CHMP opinion / CMDh position (in case PRAC recommends a variation, suspension or revocation of the MA)

If issues which prevent the adoption of a recommendation are identified, the PRAC will adopt a request for supplementary information together with a deadline for submission of the requested data by the MAH and a timetable for the assessment of the MAH's responses. The MAH will receive the adopted timetable together with the request for supplementary information. The clock will be stopped until the receipt of the requested supplementary information.

In case of major disagreement with the PRAC Rapporteur's proposed recommendation as stated in the updated assessment report, the MAH should contact the Risk Management Specialist no later than two working days following receipt of the report and indicate whether they would wish to make use of the opportunity of an oral explanation to defend their position before the PRAC. In the absence of a reply within two days, EMA will assume that no oral explanation is requested.

The MAH(s) should submit a clean and a tracked version of the agreed amended product information prior to the adoption of the PRAC recommendation.

In case the PRAC recommends any regulatory action, i.e. variation, suspension or revocation of the marketing authorisation, the PRAC recommendation will be transmitted to the CHMP if it includes at least one CAP or to the CMDh if it includes only NAPs. At its next meeting following the PRAC recommendation, the CHMP or the CMDh, as applicable, will adopt an opinion or a position, respectively. Subsequently, where the procedure includes at least one CAP, the EC will adopt a decision to the MAHs for the centrally authorised products and, as applicable, to the competent authorities of the Member States for nationally authorised products.

Where the procedure includes only NAPs, the procedure ends with the CMDh position in case of consensus and in case of a majority vote, the CMDh position will be followed by a EC decision to the Member States, which will have to be implemented according to the timetable indicated in the CMDh position or within 30 days of the CD receipt by the Member States.

Amendments to the summary of product characteristics (SmPC), labelling and package leaflet (PL) as a result of the PASS final study report assessment are directly implemented through the EC decision for centrally authorised products and through the appropriate variation at national level for nationally authorised products (including those authorised through the mutual recognition and decentralised procedures).

## References

- Directive 2001/83/EC
- Regulation (EC) No 726/2004
- Commission Implementing Regulation (EC) No 520/2012
- Guideline on good pharmacovigilance practices (GVP) Module VIII - Post-authorisation safety studies
- Guidance to applicants /marketing authorisation holders (MAHs) on oral explanations at EMA
- Timetables for non-interventional imposed PASS protocols and results

### **13.9. How is the CHMP opinion / CMDh position structured and which annexes need to be translated? *NEW Jul 2017***

The Annexes of both the CHMP opinion as well as the CMDh position will be translated into all EU languages following an agreed timetable. In addition, a linguistic review by Member States of these Annexes in all EU languages is performed after adoption of the CHMP opinion and CMDh position.

#### **Procedures that contain only centrally authorised products (CAP(s))**

- Annex B: Annexes I, II, IIIA, IIIB, IV<sup>1</sup> (scientific conclusions and grounds for the variation of the marketing authorisation) and 127a (conditions addressed to Member States)

#### **Procedures that contain a mix of centrally authorised products (CAP(s)) and nationally authorised products (NAP(s))**

For the CAP(s):

- Annex B: Annexes I, II, IIIA, IIIB, IV<sup>1</sup>(scientific conclusions and grounds for the variation of the marketing authorisation) and 127a (conditions addressed to Member States)

For the NAP(s):

- Annex C:
  - Annex I (scientific conclusions and grounds for variation to the terms of the marketing authorisations);
  - Annex II (amendments to the product information of the nationally authorised medicinal products);
  - Annex III (conditions to the marketing authorisations), as applicable.

#### **Procedures that only contain nationally authorised products (NAP(s))**

- Annex C:

- Annex I (scientific conclusions and grounds for variation to the terms of the marketing authorisations);
- Annex II (amendments to the product information of the nationally authorised medicinal products);
- Annex III (conditions to the marketing authorisations), as applicable;
- Annex III or IV (timetable for implementation<sup>2</sup>), as applicable.

## **The preparation of the translation process**

In view of the short timeframe for finalisation of the translations and in order to optimise the quality of the translations, the MAHs are strongly advised to prepare for the translation process well in advance in the pre-opinion / position stage, i.e. just following adoption of the PRAC recommendation for variation.

In case of a procedure where several MAHs are involved, EMA will coordinate the translation process by approaching the MAHs individually and provide the timelines accordingly. MAHs should translate for their products all relevant Annexes.

## **During the translation process**

Depending on the type of outcome and whether a EC Decision is required (CHMP opinion or CMDh position by majority), the timelines for the translation process vary depending on the need for a linguistic review as illustrated below:



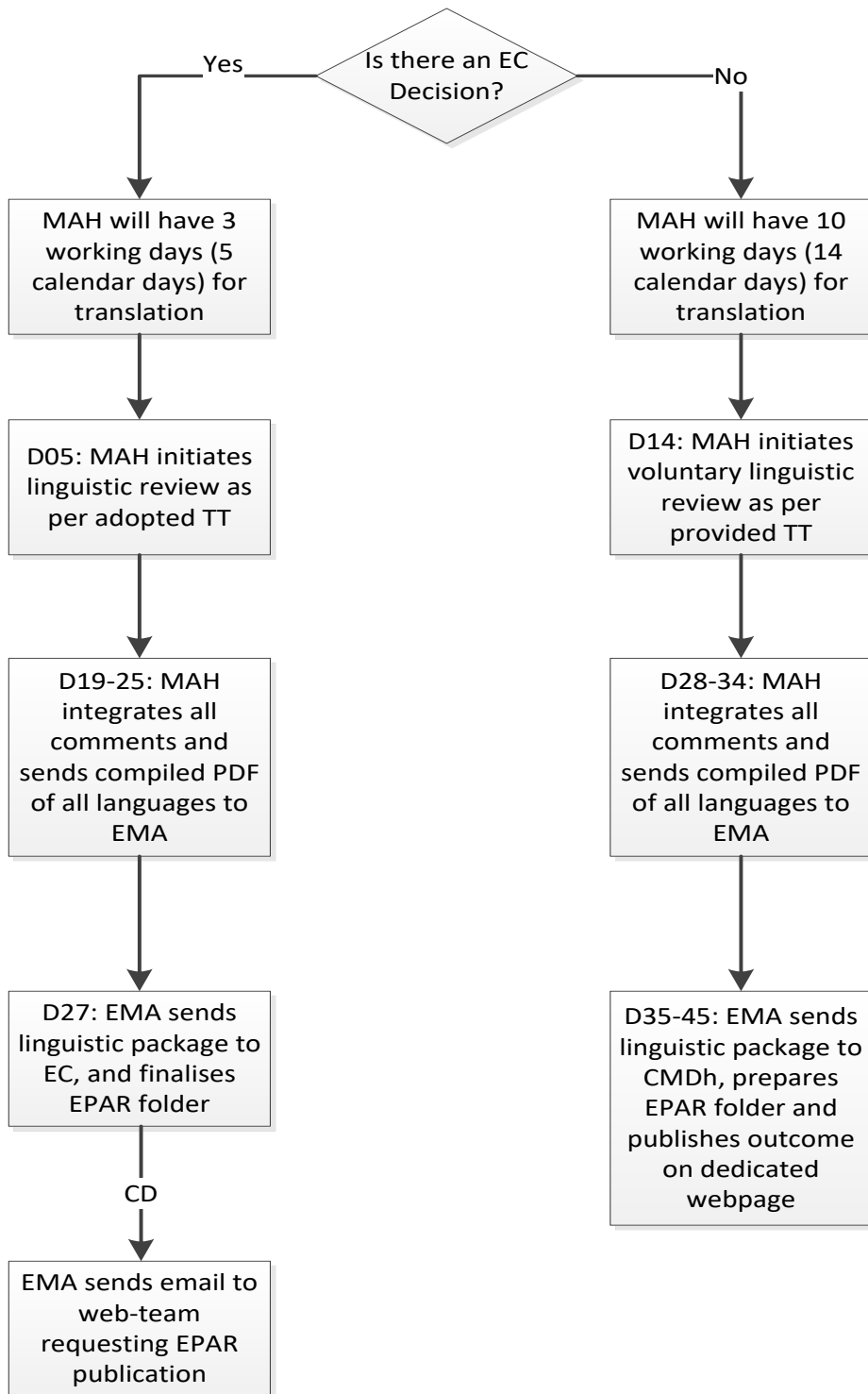

- a. In case of CHMP opinion or CMDh position by majority i.e. followed a EC Decision, the MAH has to provide the translations of the adopted Annexes in all EU languages (and in Icelandic and Norwegian – if applicable, as detailed below) according to the following timelines:

Day 5 (5 days after opinion/ position)

Translations of the adopted Annexes in EN and in all other EU languages (and in Icelandic and Norwegian) are to be provided electronically (in one Eudralink package if applicable) to the Member States (MS)

	Contact Points for Translations and to the EMA procedure assistant.
Day 19 (19 days after opinion/ position)	Member States will send linguistic comments on the Annexes to the MAH by e-mail with a copy to the Mailbox.
Day 25 (25 days after opinion / position)	<p>The MAH(s) will implement the required changes, compile the translations and send it back to the EMA.</p> <p>In case of disagreement between a Member State and the MAH, EMA will not interfere in the translation process. Disagreements should be solved directly with the concerned Member State.</p> <p>In order to facilitate and accelerate the check of the implementation of the comments, the MAH should indicate in "QRD Form 2" for each language if all comments have been implemented or not. In the latter case, a justification should be provided for the appropriate language(s) stating why certain comments are not reflected in the final texts.</p>

- b. In a case of CMDh position by consensus, Member States may perform a voluntary linguistic review in the translation process, therefore the following timelines apply:

Day 1 – 14 (1 to 14 days after position):	MAH translates the adopted Annexes in <b>all</b> other EU languages based on the EN provided version. MAHs with marketing authorisations in Iceland and/or Norway will provide translations in these languages as well.
Day 15 (15 days after the position):	Translations of the adopted Annexes in EN and all other EU languages (and in Icelandic and Norwegian, if applicable) are to be provided electronically (in one Eudralink package if applicable) to the Member States (MS) contact Points for Translations and to the EMA procedure assistant for voluntary linguistic check.
Day 28-34 (28-34 days after position)	<p>The MAH(s) will implement the required changes.</p> <p>Translation of the adopted Annexes in EN and in all other EU languages (and in Icelandic and Norwegian) are to be compiled and provided electronically (in one Eudralink package if applicable) to the EMA procedure assistant.</p>
Day 35-45 (35-45 days after position)	EMA will send the package to the CMDh and prepare the translations for publication.

## After the translation process

Once the translations are received from the MAH, the Agency will check if the comments received from Member States' have been implemented.

- a) In case of a CHMP opinion or a CMDh majority position the Agency will compile the Annexes in all languages and send the final copies to the EC, members of the Standing Committee and the MAH(s) at Day 27 (27 days after opinion).  
Following receipt of the final compiled translations, the EC will start the 22-day Standing Committee consultation, addressing only legal and public health matters (which means in principle no further linguistic review).
- b) In case of a CMDh position by consensus, the Agency will compile the Annexes in all languages, send the final copies to the Member States and, where applicable, the full set of Annexes will be published on the EMA website.

## Standards of translation of Annexes

- The structure of the English Annexes has to be strictly followed and should be exactly translated as per the adopted English version (i.e. full product information or only amendments to the relevant sections of the product information).
- For translations of Annexes QRD templates for each language should be used
- The title pages should be adjusted and all brackets (i.e. <>) are taken out in the title.
- Sections should not be left out, and Annex III should not be updated, e.g. the sections [to be completed on a national level] simply to be translated as 'to be completed on a national level'.
- Good quality of the translations and compliance with the Member States' comments are required to facilitate the process.

If a translation is considered not to be of an acceptable quality, the Member State concerned will inform the MAH and the Agency within 3 days of receipt of the translation. The Agency will inform the MAH of the insufficient quality of the translations and the transmission to the EC will be delayed until receipt of the amended translation (which would be expected within 1 week). A revised timetable will then be prepared.

The MAHs are also strongly advised to liaise directly with the Member States in case of disagreement with any of the comments made or in case further clarification on some comments is required, and to reflect the outcome in "QRD Form 2".

In addition, the MAHs are reminded that in case the complete product information is part of Annex III, it should be presented in strict compliance with the QRD Convention (e.g. format, layout and margins).

The Agency will monitor the quality of the translations, the review by the Member States and MAHs' compliance with the Member States' comments as part of the Performance Indicators.

## References

- QRD Convention
- Product Information Templates
- Product Information: Reference documents and guidelines

- List of Member States contact points for translations (with guidance on the sending of product information to Member States)
- User guide on the preparation of PDF versions of the product information
- EC Guideline on the operation of the procedures laid down in Chapters II, III and IV of Commission Regulation (EC) No 1234/2008 of 24 November 2008

**13.10. How shall I implement the outcome of a non-interventional imposed PASS final study report procedure? *NEW Jul 2017***

Depending on the type of outcome and whether an EC Decision is required (i.e. CHMP opinion or CMDh position by majority/ consensus), the implementation of the outcome of a non-interventional imposed PASS results vary as illustrated in the table below. For NAPs, further guidance on implementing variation can also be found on the CMDh website (Question & Answers, Pharmacovigilance legislation).

Of note, products that are not involved directly in the procedure (i.e. products not listed in the Annex to the CHMP opinion or CMDh position) might be affected by the outcome and should implement accordingly when the adopted changes are applicable to their MA.

	CAP products		NAP products	
Product involved in procedure	Yes	No	Yes	No
Implementing variation needed, type and classification	Not applicable; implemented through EC decision to MAH	Yes (if changes applicable) IB C.1.3.z	Yes - IA <sub>IN</sub> C.1.3.a (harmonised national translations available) - IB C.1.3.z (adaptation of wording needed) - II (new data submitted; classification dependent on proposed changes)	Yes (if changes applicable) - IA <sub>IN</sub> C.1.3.a (harmonised national translations available) - IB C.1.3.z (adaptation of wording needed) - II (new data submitted; classification dependent on proposed changes)

<b>Timeframe for submission of variation</b>	Not applicable	MAHs to submit variations within two months after receipt of the EMA communication encompassing the safety updates referred to in the relevant procedure	For CMDh position by consensus (no EC decision adopted): As per the date indicated in the translation timetable i.e. 105 <sup>5</sup> calendar days after adoption of the CMDh position (see Question 10).	
			For CMDh position by majority vote or CHMP opinion (EC decision adopted): <b>10 days</b> after publication <sup>6</sup> of EC decision on EC website.	For CMDh position by majority vote or CHMP opinion (EC decision adopted): <b>60 days</b> after publication of EC decision on EC website.

### **13.11. When should I register my studies in the EU PAS Register? *NEW Jul 2017***

According to Article 26(1)(h) of Regulation (EC) No 726/2004, protocols and public abstracts of results of non-interventional PASS imposed in accordance with Article 10 or 10a of Regulation (EC) No 726/2004 or with Articles 21a or 22a of Directive 2001/83/EC shall be made public by the Agency. In addition, Annex III of Commission Implementing Regulation (EC) No 520/2012 specifies that the final study report of imposed non-interventional PASS must provide the date of registration in the EU PAS Register.

MAH(s) should enter in the European Union electronic Register of Post-Authorisation Studies (EU PAS Register) protocols and public abstracts of results of non-interventional imposed PASS conducted in accordance with Articles 107n-q of Directive 2001/83/EC within one month after the relevant PRAC recommendation.

After this deadline, the Agency will contact MAH(s) to make sure the information is available in the register and, unless alternative timelines are agreed, will enter the information on its own initiative in order to fulfil its legal obligations under Article 26(1)(h) of Regulation (EC) No 726/2004.

<sup>5</sup> 45 calendar days for translation publication + 60 calendar days from publication of translations

<sup>6</sup> See also Q 3.3 of the Q/A-LIST FOR THE SUBMISSION OF VARIATIONS ACCORDING TO COMMISSION REGULATION (EC) 1234/2008

In addition, EMA strongly encourages MAHs to upload the final study results in the EU PAS register in order to support transparency on non-interventional PASS and to facilitate exchange of pharmacovigilance information between the EMA, NCAs and MAHs.

More information on how to provide documents to the EU PAS Register for PASS studies can be found here: [EU PAS Register](#)

## References

- Directive 2001/83/EC
- Regulation (EC) No 726/2004
- Commission Implementing Regulation (EC) No 520/2012
- Guideline on good pharmacovigilance practices (GVP) Module VIII - Post-authorisation safety studies

### **13.12. Are outcomes of non-interventional imposed PASS published? *NEW Jul 2017***

Protocols and public abstracts of results of imposed non-interventional PASS are publicly available in the EU PAS Register on the European Network of Centres in Pharmacoepidemiology and Pharmacovigilance (ENCePP) website.

The outcomes of imposed non-interventional PASS final study results assessments for active substances found only in centrally authorised medicines are published as part of each medicine's European public assessment report (EPAR).

The outcome for nationally authorised medicinal products included in 'mixed' procedures where centrally authorised products were also involved can be found on the Union register maintained by the EC.

EMA publishes the outcomes of final study results of non-interventional imposed post-authorisation safety studies (PASS) for NAPs on the EMA website.

## References

- The European Union electronic Register of Post-Authorisation Studies (EU PAS Register)
- European public assessment reports
- Union register
- Outcomes of imposed non-interventional post-authorisation safety studies

### **13.13. What fee do I have to pay? *NEW Jul 2017***

As per Part II of the Annex to the Regulation EC No 658/2014, the fee for the assessment of PASS shall be paid in two instalments:

- first instalment (40%) for the assessment of the draft protocol (Article 107n of Directive 2001/83/EC);
- second instalment (60%) for the assessment of the final study report by the PRAC (Article 107q of Directive 2001/83/EC).

The Agency does not levy a fee for the assessment of significant protocol amendments as defined in Article 107o of Directive 2001/83/EC.

In case of a joint PASS (i.e. several marketing authorisation holders working together to conduct the PASS), the total amount of the fee will be divided equally among all the marketing authorisation holders concerned.

EMA has published further guidance on how the fees are calculated and collected.

For any remaining question, the dedicated EMA fees query form can be completed and submitted.

### References

- Regulation (EC) No 658/2014
- Pharmacovigilance fees payable to the European Medicines Agency
- Pharmacovigilance fees: questions and answers

### **13.14. Who should I contact if I have questions regarding my submission? Rev. Feb 2019**

For centrally authorised products, if you cannot find the answer to your question in this Q&A when preparing your application, please contact the Risk Management Specialist (RMS) assigned to your product.

PASS protocols and final study results for NAPs will be handled by the RMS. You will be able to contact this RMS throughout the procedure.

For pre-submission queries that are not covered by this guidance please submit your query using the following web form.

In the web form you will be asked to provide your name, the name of your employer or organisation, contact details and the subject of your enquiry. You should type the full details of your query in the appropriate space. The use of key words in the subject line will help the Agency allocate your query to the correct person.

Please give as much detail as possible when completing your request and be sure to include your correct and complete contact details. If the contact details you provide are incomplete or inaccurate this may prevent the Agency from communicating with you. In case of incomplete or incorrect data in the web form, the request may not be processed.

For questions related to fees, please use the dedicated EMA fees query form instead (refer to Q.14).

For technical queries related to the submission please contact us through the EMA Service Desk portal.

### **13.15. Scientific advice for safety studies *Rev. May 2017***

The Agency encourages scientific advice on safety studies to further develop an integrated lifecycle approach in the advice on medicines across safety, quality, efficacy pre- and post-authorisation, and to support proactive pharmacovigilance planning, which is elaborated through the Scientific Advice Working Party (SAWP) with the Pharmacovigilance Risk Assessment Committee (PRAC) endorsing the scientific advice letters in the case of PASS protocols.

Scientific advice on safety studies is a voluntary procedure for Marketing Authorisation Holders (MAH) or Applicants, and complementary to existing ones.

#### **13.15.1. Why should I consider seeking scientific advice on PASS?**

By engaging in scientific advice on PASS, Applicants or Marketing Authorisation Holders (MAH) can benefit from

- a strengthened PRAC-SAWP interaction
- a lifecycle approach to medicines advice with integrated advice on all aspects of medicines development from involved Committees
- support for proactive pharmacovigilance planning
- advice at an early or late stage of the protocol development
- targeted advice on key issues
- a well-defined procedural timetable
- a pre-submission interaction with Agency secretariat to consider suitability and validity of the dossier
- a face to face meeting with involved regulators during the procedure
- engagement with patient representatives
- options to include other stakeholders such as HTAs or FDA further supporting optimised evidence generation
- the possibility of seeking follow up advice.

#### **13.15.2. Which post-authorisation safety studies could benefit from scientific advice? *NEW May 2017***

Applicants/MAHs are encouraged to request scientific advice (SA) from the Agency on specific aspects of PASS protocols, especially for complex or controversial issues or for innovative approaches or methodologies. Following experience gained from the scientific advice PASS pilot phase, scientific advice is encouraged to be sought for non-imposed PASS i.e. the category III PASS.

Applicants/MAHs wishing to request scientific advice on specific aspects of PASS protocols /or joint protocols by a consortium of MAH for PASS imposed as conditions to the marketing authorisation (i.e category I and II PASS), can also submit a SA request. This is without prejudice to the provisions laid down in Article 107n of Directive 2001/83/EC for protocols of non-interventional imposed PASS to be assessed and endorsed by the PRAC.



### **13.15.3. Does EMA expect all PASS studies to go through scientific advice?**

Scientific advice is a voluntarily procedure and it is the choice of the MAHs or Applicants to submit scientific questions related to PASS / PASS draft protocol for scientific advice.

### **13.15.4. Could requests for 'mixed' advice be submitted e.g. questions on pre-marketing and post-marketing phases, or questions on PASS and pivotal phase III studies, or questions on interventional and non-interventional studies?**

Yes, such mixed advices are possible.

### **13.15.5. Can a draft PASS protocol be submitted for scientific advice although the marketing authorisation application is still under assessment?**

Early submissions of PASS protocols for scientific advice are possible. However, Applicants should duly consider the best timing for their request for scientific advice, i.e. whether at the moment of the submission there are sufficient certainties about the status and the objectives of the study.

### **13.15.6. Can scientific advice be sought for nationally as well as centrally authorised products?**

Yes, scientific advice can be sought for nationally as well as centrally authorised products.

### **13.15.7. Can a follow up advice be requested?**

Yes. Follow up procedures are possible.

### **13.15.8. Who will assess the PASS protocols for SAWP?**

As per existing scientific advice procedures, the assessment is led by SAWP delegates acting as SAWP coordinators. Two SAWP members/alternates are appointed as coordinators for each scientific advice procedure. A further PRAC peer-reviewer is appointed to provide additional product specific PRAC input.

### **13.15.9. How will the PRAC Rapporteur for a product be involved in the scientific advice?**

The PRAC Rapporteur for a specific product is involved through either the SAWP coordinators (i.e. assessment team from the same member state) or appointed as the PRAC peer-reviewer for a specific scientific advice procedure.

### **13.15.10. Is the necessary expertise available in SAWP to evaluate PASS protocols?**

Expertise in pharmacoepidemiology needed to evaluate PASS protocols, is available through the extension of the SAWP currently to 2 joint SAWP - PRAC delegates who can also act as SAWP coordinators for a specific scientific advice product procedure.

### **13.15.11. What is the role of the PRAC within the scientific advice procedure for PASS protocols?**

Scientific advice procedures for PASS will involve PRAC systematically at all the stages of the procedure. All scientific advice documents will be available to the PRAC during the procedure. The PRAC will endorse the advice relating to PASS, and a Final Advice Letter will be issued.

Each procedure will have a named PRAC peer-reviewer appointed to provide product specific PRAC input. The PRAC Rapporteur for a product will be systematically involved either through the SAWP coordinatorship or as PRAC peer-reviewer roles to ensure continuity across procedures through the lifecycle of the products.

### **13.15.12. For non-imposed PASS (category III), is it mandatory for companies to submit the study protocols to PRAC?**

For category III studies, there is no legal obligation for companies to submit the protocol to the PRAC. However, the PRAC may request to review the protocol of some of these category III studies which are of interest for the committee and for which such submission of protocol is reflected as a milestone in the Risk Management Plan.

Please note that the advice provided within this pilot is without prejudice to any national requirement regarding the PASS protocols that might be in place in some Member states.

### **13.15.13. What about non-imposed PASS protocols required to be submitted by the PRAC that have not been through an EMA scientific advice procedure?**

The final protocols for non-imposed PASS required by the PRAC can continue to be submitted to the PRAC as a Post-authorisation measure (PAM).

### **13.15.14. How do I apply for scientific advice on a PASS protocol?**

A letter of intent for scientific advice should be submitted to the Agency at the mailbox [scientificadvice@ema.europa.eu](mailto:scientificadvice@ema.europa.eu) together with a briefing document in accordance with published EMA scientific advice guidance and timelines. See [link here](#).

### **13.15.15. What is the format of the briefing document?**

The MAH or Applicant provides questions and an accompanying justification of the approach taken with the relevant introduction, background, annexes and references. Please see the published scientific advice template.

### **13.15.16. What kinds of annexes are required?**

Protocols or synopses, SmPCs, Risk Management Plans and assessment reports pertinent to the topic should be annexed as appropriate. Ready availability of relevant documents and references facilitates assessment.

### **13.15.17. What type of question is expected to be raised for the concerned study protocols?**

In general, any question pertaining to the draft protocol can be posed in the draft briefing document. Feedback on whether the MAH or Applicant's draft questions can be validated as posed or reworded will be given at the validation stage.

### **13.15.18. Could questions be asked about the choice of the adverse reactions of interest?**

In general, any question pertaining to the draft protocol can be posed in the draft briefing document. Feedback on whether questions can be validated as posed or reworded will be given at the validation stage. Specifically, scientific advice can be sought for the selection of adverse reactions of interest.

### **13.15.19. How will scientific advice procedures for safety studies be run?**

In summary, scientific advice will follow the same procedure as other scientific advice with the exception of involvement of PRAC, the appointment of PRAC peer-reviewer, and endorsement of the letter by PRAC.

The EMA Secretariat should be formally notified of the intent to submit a scientific advice or protocol assistance request via a Letter of Intent. A Letter of Intent should be sent by email to [scientificadvice@ema.europa.eu](mailto:scientificadvice@ema.europa.eu) in advance of the anticipated start of the procedure. The latest PDF letter of Intent form provided on the EMA scientific advice website should be used.

The draft package should be presented in line with published template for scientific advice. A pre-submission meeting with Agency staff will be arranged to consider the suitability and validity of the submission. Following the pre-submission meeting and validation, an amended electronic final package is submitted and circulated to the appointed coordinators and experts in line with agreed timelines.

The SAWP Coordinators will then draft preliminary reports in response to the scientific advice or protocol assistance requests taking into account the timetable for evaluation of such requests. In addition to the SAWP coordinators and the joint PRAC SAWP delegate, a PRAC peer-reviewer is appointed to follow the procedure. The preliminary reports are discussed in the scientific advice plenary meeting and are made available to the involved Working Parties, Committees, and experts as appropriate. A list of issues for discussion at the Discussion meeting is sent to the MAH/Applicant (See figure 1 below SAWP 2). A face to face discussion meeting with the MAH/Applicant and members of the SAWP is held the following month (See figure 1 below SAWP 3).

Following the discussion meeting with the MAH/Applicant, and further to the SAWP plenary discussion, the SAWP Coordinators issue a draft joint report for comments by the involved participants.

All submission documents and reports are available to all PRAC members throughout the procedure. The final advice letter is endorsed by the PRAC and adopted by the CHMP through a written procedure before sending to the MAH/Applicant. SAWP will report to PRAC at each phase of the procedure.



Figure 1: Overview of scientific advice procedure on PASS.

Further details on routine scientific advice procedure are available.

### **13.15.20. Is a pre-submission meeting always expected or can the MAH/Applicant choose not to have one?**

The experience from the pilot phase showed an added value of pre-submission meetings and therefore it is proposed that all procedures would have such meetings to discuss the briefing document. However, the MAH/Applicant can choose not to request one.

### **13.15.21. Is a discussion meeting with the MAH/Applicant during the procedure always expected?**

The need for a discussion meeting is decided following the discussion of preliminary reports at SAWP plenary and it might not be considered necessary in some cases.

### **13.15.22. What is the nature of the discussion meeting?**

Information regarding the discussion meeting is provided in the FAQ 21 "How do I prepare for a Discussion meeting?" in the published scientific advice guidance.

### **13.15.23. Can additional data or amended protocols be submitted during the procedure?**

Additional data or amended protocols can be submitted at a specific point during the scientific advice procedure further to the SAWP list of issues. The MAH/Applicant may also propose in writing to the Agency additional points for discussion that are not part of the adopted list of issues and submit these in writing ahead of the Discussion meeting. Any amendment/change to the development programme should be notified to the Agency /SAWP ahead of the discussion meeting.

### **13.15.24. Will the EMA support for these protocols be different from any other scientific advice?**

Procedures for PASS protocols will not be handled any differently than for existing scientific advice procedures except the extension to and inclusion of PRAC interactions and relevant Agency staff, such as the Risk Management Specialist.

### **13.15.25. Will fees be levied for scientific advice provided for PASS protocols?**

Yes, in accordance with the Agency's Fee Regulation<sup>7</sup> and its corresponding Implementing Rules<sup>8</sup>, fees will be levied on MAH/Applicants seeking scientific advice on PASS protocols.

In this context, two different types of scientific advice fees are applied depending on whether the request is an 'initial request' or a 'follow-up'. For further details on fees and fee incentives/reductions please consult the Explanatory Note on fees payable to the EMA and the section on fees on the Agency's website.

### **13.15.26. Where can I find further information about scientific advice?**

Please see the published EMA scientific advice guidance for many FAQs.

#### **Reference**

- Pharmacovigilance fees payable to the European Medicines Agency

### **13.16. When and how should study progress reports and interim results be submitted? *Rev. Apr 2021***

The timelines of the progress reports for a given study should be pre-specified and indicated in the protocol. These progress reports may include available interim results, but there is in general no obligation or recommendation to include interim results in RMPs unless required as part of an agreed pharmacovigilance plan. This is without prejudice that a variation as appropriate should be submitted should these interim results lead to product information changes or RMP changes.

For centrally authorised products, progress reports and interim results, when requested, should be submitted as post-authorisation measure (PAM) and should follow the timetable of PAMs assessed by PRAC.

---

<sup>7</sup> Council Regulation (EC) No 297/95 on fees payable to the European Medicines Agency

<sup>8</sup> Rules for the implementation of Council Regulation (EC) No 297/95 on fees payable to the European Medicines Agency and other measures EMA/MB/530034/2014

## 14. Post-authorisation efficacy study (PAES)

### **14.1. What is a PAES imposed in accordance with the Commission Delegated Regulation?**

PAES imposed in accordance with the Commission Delegated Regulation (EU) No 357/2014 it is meant an efficacy study which is requested by a Competent Authority pursuant to at least one of the situations set out in this said regulation. The data resulting from such a PAES conducted within an authorised therapeutic indication are required to be submitted as they are considered important for complementing available efficacy data in the light of well-reasoned scientific uncertainties on aspects of the evidence of benefits that is to be, or can only be, addressed post-authorisation. The results of the PAES have the potential to impact on the benefit-risk of the medicinal product or product information.

Such efficacy study conducted post-authorisation can be imposed either:

- at the time of granting the initial marketing authorisation (MA) where concerns relating to some aspects of the efficacy of the medicinal product are identified and can be resolved only after the medicinal product has been marketed; or
- after granting of a MA where the understanding of the disease or the clinical methodology or the use of the medicinal product under real-life conditions indicate that previous efficacy evaluations might have to be revised significantly.

It is also possible to impose the conduct of post-authorisation efficacy studies in the specific situations of a conditional MA, a MA granted in exceptional circumstances, a MA granted to an advanced therapy medicinal product, the paediatric use of a medicinal product, a referral procedure initiated under Article 31 or Article 107i of Directive 2001/83/EC or Article 20 of Regulation (EC) No 726/2004, however these fall outside the scope of the Delegated Regulation.

#### **References**

- Regulation (EC) No 726/2004
- Directive 2001/83/EC
- Commission Delegated Regulation (EU) No 357/2014
- Draft scientific guidance on post-authorisation efficacy studies

### **14.2. How and where the PAES imposed in accordance with the Commission Delegated Regulation will be reflected in the marketing authorisation? *Rev. Jan 2021***

For centrally authorised medicinal products ("CAPs"), a PAES imposed as a condition to the MA is reflected in Annex II under section D "Obligation to conduct post-authorisation measures".

The study objective and the deadline for the submission of the final study results are specified in the Annex II. At the beginning of the description of the study, such efficacy study imposed in accordance with the Delegated Regulation is explicitly named 'Post-Authorisation Efficacy Study (PAES)'.

The imposition of such PAES shall meet one of the criteria set out in the Delegated Regulation. A justification will be provided in the CHMP assessment report.

If the MAH has to submit the protocol for endorsement by the European Medicines Agency, this will be reflected in Annex II in the wording of the condition (e.g. “according to an agreed protocol”).

Any post-approval amendments to the conditions in Annex II (objective and/or due date) should be duly justified and submitted as a variation, type IB C.I.11.z) for change in the due date or type II C.I.11.b) for changes other than the due date.

As for any imposed post-authorisation efficacy studies, those imposed in accordance with the Delegated Regulation should also be reflected in the risk management plan (“RMP”), part IV ‘Plans for post-authorisation efficacy studies’.

#### **References**

- Commission Delegated Regulation (EU) No 357/2014
- GVP module on RMP

### **14.3. Following which procedure will my imposed PAES protocol be assessed?**

If the review of the imposed PAES protocol has been reflected in the Annex II, the MAH will have to submit a draft protocol to the European Medicines Agency as a post-authorisation measure (“PAM”). Otherwise, the review of the protocol is not deemed necessary.

The MAH is generally advised to consider seeking scientific advice on the study design irrespective of whether the submission of the protocol has been requested, in order to discuss the design of the study and ensure that it meets the intended objectives.

In case the PAES is a clinical trial, it falls under the scope of Directive 2001/20/EC (to be superseded by the Clinical Trial Regulation (EU) No 536/2014) and is subject to the national clinical trial authorisations.

#### **References**

- Scientific advice procedure
- EMA post-authorisation procedural advice for users of the centralised procedure (PAG) – Post-authorisation measures (PAMs)
- Directive 2001/20/EC
- Regulation (EU) No 536/2014 on clinical trials for medicinal products for human use

### **14.4. When should I submit my imposed PAES protocol? *Rev. Feb 2019***

If the submission of the protocol has been requested in the Annex II, the MAH should submit the protocol in accordance with the timeframe specified in the RMP, part IV as timelines for protocol submission are not specified in the Annex II.

At time of imposition, the MAH is asked to propose appropriate dates for the submission of the protocol and the post-authorisation data that are proportionate to the uncertainty to be addressed. The proposed dates for submission are subject to agreement with the Agency’s Committee(s).

If the MAH would be unable to provide the protocol by the specified deadline, the MAH must inform the Agency and the Rapporteur in writing as early as possible in advance of the submission due time. The delay must be duly justified and a new submission date should be proposed. Such request should be sent to your Product Lead and will be subject to agreement by the Committee(s).

If the submission date of the final study results mentioned in the Annex II is impacted, this requires the submission of a type IB variation C.I.11.z).

#### ***14.5. In which timeframe will my imposed PAES protocol be evaluated (timetable)?***

The evaluation of the PAES protocol will be led by the CHMP with consultation of other committees where foreseen. The evaluation will be handled as a 60-day PAM procedure, which follows the timetables available on the Agency's website.

The protocol assessment will start in accordance with the published timetable for PAMs which is available on the following webpage.

#### ***14.6. What are the possible outcomes of the evaluation of an imposed PAES protocol?***

The CHMP, taking into account advice of other committees where provided, will conclude the assessment of the protocol according to the following options:

- endorsement of the protocol;
- objection to the protocol;

In case of endorsement, the assessment report may still include recommendations for amendments to the protocol. These recommendations are for consideration by the MAH and do not require resubmission of the protocol.

In case of objection, resubmission of an amended protocol for reassessment will be required.

#### ***14.7. Do I have to submit interim results?***

There is no obligation to submit interim results, unless it has been requested by the Committee(s).

However, when requested, interim results should be submitted as a PAM (see: Under which procedure should I submit my PAM?) unless there is an impact on the product information. In such case a variation should be submitted.



#### **14.8. Do I have to submit the final results of my imposed PAES? Rev. Jun 2016**

Upon completion of the study, a final study report shall be submitted by the deadline specified in Annex II via the appropriate variation procedure irrespective of changes to the product information.

The MAH should consider whether the final results have an impact on the marketing authorisation. If the MAH concludes that this is the case, the MAH should submit the results together with the proposed changes to the product information.

The classification of the variation will depend on whether there are proposed changes to the product information.

With the application submitted, the MAH should indicate in the table of the cover letter of the application which post-authorisation measure is being addressed and the full description of the relevant measure.

The CHMP will lead on the assessment of the study results and will conclude, taking into account advice of other Committees where provided.

In addition, it is reminded that the MAH should provide in the PSUR, as usual, a summary of the clinically important efficacy and safety findings obtained from the study during the reporting interval.

#### **14.9. Do I have to pay fees for the protocol and final study results submission?**

There is no fee payable for the protocol submission as a PAM procedure.

For the final study results submission, there are fees applicable to the related variation procedure.

#### **14.10. How is a PAES enforced?**

The Agency will keep a record of the post-authorisation measure and its due date in its database.

In case of overdue condition or a MAH being found non-compliant in satisfying such condition, the competent authorities will consider the need for appropriate actions to be taken.

In such situations, the Rapporteur (or a lead Rapporteur nominated by the Committee in case of more than one affected product) may draft an assessment report on the impact of the lack of data on the benefit/risk balance of the affected medicinal product(s). Based on the outcome of such assessment and/or discussion, one or more of the following actions may be taken:

- Letter to the MAH by the Chair of the Committee
- Oral Explanation by the MAH to the Committee
- Initiation of a referral procedure with a view to vary/suspend/revoke the MA
- Inspection to be performed upon request of the Committee(s)

Such regulatory action in regards to non-compliance of the MAH may be made public on the Agency website, e.g. in the EPAR(s) of the affected medicinal product(s).

## References

- Directive 2001/83/EC
- Regulation (EC) No 726/2004

### **14.11. Will there be any publication on the outcome of my PAES protocol and final study results assessment?**

Outcome of protocol assessment are not published on the EMA Website. However, in case of a clinical trial the protocol and summary will be available in the clinical trials database, as per usual procedure.

Outcome of final study results will be published in the EPAR under 'Procedural steps taken and scientific information after the authorisation'. Relevant results of the study will be included in the SmPC.

To support transparency on PAES that are outside the scope of Directive 2001/20/EC, study information (including for studies conducted outside the EU) should be made available in the EU electronic register of post-authorisation studies (EU PAS Register) maintained by the Agency.<sup>9</sup>

## References

- EPARs

### **14.12. Who should I contact if I have a question when preparing my application and during the procedure? *Rev. Feb 2019***

If you cannot find the answer to your question in this Q&A when preparing your application or during the procedure, please contact the Product Lead responsible for your product.

---

<sup>9</sup> [http://www.encepp.eu/encepp\\_studies/indexRegister.shtml](http://www.encepp.eu/encepp_studies/indexRegister.shtml)

## 15. Post-Authorisation Measures (PAMs)

### 15.1. What are PAMs? *Rev. Apr 2015*

At the time of finalising a procedure or in follow-up of a signal evaluation, the Agency’s Committee(s) may agree that the applicant/MAH should provide additional data post-authorisation, as it is necessary from a public health perspective to complement the available data with additional data about the safety and, in certain cases, the efficacy or quality of authorised medicinal products. Such post-authorisation measures (PAMs) may be aimed at collecting or providing data to enable the assessment of the safety or efficacy of medicinal products in the post-approval setting.

The existence of such a system of PAMs does not aim at promoting premature approvals of marketing authorisations or post-authorisation procedures. The background and rationale for requesting PAMs will be described in the relevant assessment, which will present the context and nature of the PAM. Based on the assessment of the committee(s), PAMs are classified into their appropriate legal framework under which they will be enforced.

The following diagram explains how PAMs are categorised; in addition, each PAM category is explained in the following sections:

**Fig.: Schematic overview of decision tree for the classification of PAMs**

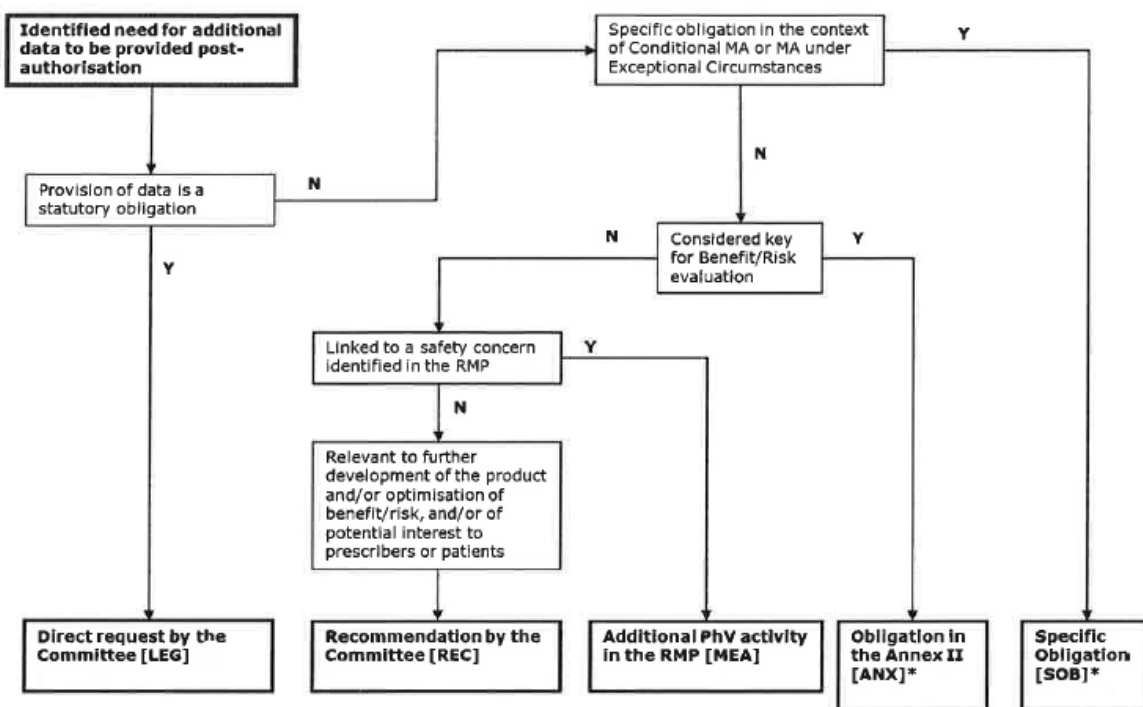

\* plus potentially also additional PhV activity in the RMP [MEA] if linked to a safety concern identified in the RMP

Consequently, PAMs fall within one of the following categories [EMA codes<sup>10</sup>]:

- specific obligation [SOB]
- annex II condition [ANX]
- additional pharmacovigilance activity in the risk-management plan (RMP) [MEA] (e.g. interim results of imposed/non-imposed interventional/non-interventional clinical or nonclinical studies)
- legally binding measure [LEG] (e.g. cumulative review following a request originating from a PSUR or a signal evaluation [SDA], Corrective Action/Preventive Action (CAPA), paediatric [P46] submissions, MAH's justification for not submitting a requested variation)
- recommendation [REC] e.g. quality improvement

Only certain medicinal products can be subject to specific obligations (see also '*What is a Specific Obligation?*'). PAMs other than specific obligations can be required for any type of authorisation and will be included in the opinion of an initial marketing authorisation or further to the committees' assessment during post-authorisation.

The wording of the PAM will describe the issue under investigation that has led to the request together with a clear outline of the studies or activities expected to address it and the deadline for its submission. Compliance with these measures is defined by both the submission of the requested data and adherence to the agreed timeframe.

## References

- Directive 2001/83/EC
- Regulation (EC) No 726/2004

## **15.2. What is a specific obligation ['SOB']? Rev. Dec 2017**

Specific obligations can only be imposed on marketing authorisations granted under exceptional circumstances or on conditional marketing authorisations (see also questions on 'Is my medicinal product eligible for approval under exceptional circumstances?' and 'Could my application qualify for a conditional marketing authorisation?' of the Agency's pre-submission guidance). These are conditions to the marketing authorisation included in annex II.E of the Commission decision and form the basis of the annual re-assessment or the annual renewal. These may also be additional Pharmacovigilance activity and will be included as well in the RMP (category 2 studies).

Continuation of a marketing authorisation under exceptional circumstances or the renewal of a conditional marketing authorisation will be determined by the MAH's compliance with the specific obligations, which are checked annually as part of either the annual reassessment or the annual renewal procedures.

As specific obligations are binding conditions to the marketing authorisation, any modification proposal by the MAH with regards to their **description or due date** (as described in Annex II of the product

---

<sup>10</sup> These codes relate to the Agency's product and procedures tracking database called SIAMED and will be used, together with a numbering system, to identify each PAM of a medicinal product both in the database and in any correspondence of the Agency with the MAH

information) has to be submitted within an appropriate procedure, i.e. either within the annual re-assessment, the annual renewal or a variation application.

**Interim results** not impacting on the product information or on the description of the specific obligation can be submitted as a PAM as described below, if they are not part of the annual reassessment or annual renewal. (see: *How and to whom shall I submit my PAM data?*).

In case of interim results impacting on the product information, a variation should be submitted without waiting for the annual re-assessment or annual renewal.

**Final results** leading to the **fulfilment of the specific obligation** should be submitted within an appropriate procedure, i.e. either within the annual re-assessment, the annual renewal or a variation application.

Where a specific obligation falls within the definition of a non-interventional post-authorisation safety study (PASS) imposed after 2 July 2012, the MAH will have to follow the procedure for review of imposed PASS protocols and results as described in the Agency's post-authorisation procedural advice on PASS and in the corresponding guideline on good pharmacovigilance practices (GVP): Module VIII - PASS.

## References

- Directive 2001/83/EC
- Regulation (EC) No 726/2004
- Commission Regulation (EC) No 507/2006 on conditional marketing authorisation
- EMA post-authorisation procedural advice on PASS
- Guideline on good pharmacovigilance practices (GVP) Module VIII – Post-authorisation safety studies

### **15.3. What is an annex-II condition ['ANX']? Rev. Jun 2016**

The European Commission can impose on the marketing authorisation holder (MAH) the obligation to conduct post-authorisation measures. These obligations can be imposed at the time of the granting of the marketing authorisation or later, as conditions to the marketing authorisation. These are conditions to the marketing authorisation included in Annex II.D of the marketing authorisation. These may also be additional Pharmacovigilance activity and will be included in the RMP (category 1 studies).

Annex-II conditions are post-authorisation measures which, whilst not precluding the approval of a marketing authorisation or other post-authorisation procedures, are considered to be key to the benefit / risk balance of the product. These can consist of post-authorisation safety or efficacy study.

As annex-II obligations are binding conditions to the marketing authorisation, any **modification** proposal by the MAH with regards to their **description or due date** has to be submitted as a variation application.

**Interim results** not impacting on the product information or on the condition as stated in the Annex II can be submitted as a PAM as described in question *How and to whom shall I submit my PAM data?*.

Final results leading to the fulfilment of the Annex II condition should be submitted as a variation application.

Where an annex-II condition falls within the definition of a non-interventional PASS imposed after 2 July 2012, the MAH will have to follow the procedure for review of imposed PASS protocol and results as described in the Agency's post-authorisation procedural advice on PASS and in the corresponding guideline on good pharmacovigilance practice (GVP): Module VIII - PASS.

#### References

- Directive 2001/83/EC
- Regulation (EC) No 726/2004
- EMA post-authorisation procedural advice on PASS
- Guideline on good pharmacovigilance practices (GVP) Module VIII – Post-authorisation safety studies

#### **15.4. What is an additional pharmacovigilance activity in the risk-management plan ['MEA']? *Rev. Aug 2020***

Additional pharmacovigilance activities in the RMP (category 3 studies) may be non-clinical studies, clinical trials or non-interventional studies which are required to investigate a safety concern of a medicinal product. These studies are listed in the pharmacovigilance plan of the risk-management plan (RMP) and are either aimed at identifying and characterising risks, or at assessing the effectiveness of risk-minimisation activities.

All relevant milestones, together with their due dates should be included in the summary table of additional PhV activities in the RMP. The MAH has the obligation to provide the requested data within the stated timeframes.

Once additional pharmacovigilance activities have been agreed within the RMP, changes to these measures (e.g. proposals for adjusting due dates of agreed milestones, proposals to change the scope of agreed study or its duration, etc.) should be submitted via the appropriate variation procedure to amend the RMP.

Information not impacting on the product information or description/due date of the measure itself, (e.g. interim results) , can be submitted as a self-standing PAM as described in question *How and to whom shall I submit my PAM data?*.

Submissions of final study reports leading to the fulfilment of a MEA should be addressed via the appropriate variation procedure. (see also: Under which procedure should I submit my PAM?).

#### References

- Directive 2001/83/EC
- Regulation (EC) No 726/2004
- EMA pre-submission procedural advice on RMP
- Guideline on good pharmacovigilance practices (GVP) Module V – Risk management systems

## **15.5. What is a legally binding measure ['LEG']? Rev. May 2020**

Some post-authorisation measures (PAMs) are already defined as statutory obligations in the pharmaceutical legislation. As such, they have to be fulfilled by the MAH upon request of the Agency and its committees. Examples for such directly binding legal measures evaluated as PAMs are:

- Requests for provision of data as a stand-alone submission (e.g. cumulative review following a PSUR assessment).
- Requests for supplementary information to evaluate a signal (see EMA's Questions and answers on signal management)
- Requests for update of the product information
- Obligations to submit any data requested in relation to CAPA corrective action or preventive action (CAPA) in the context of inspections
- Submission of final results of study involving paediatric patients submitted in fulfilment of Article 46 of the paediatric regulation.

Where requested, these are directly addressed to the MAH by the Agency, either within the assessment report of the committee(s) or within a letter informing about the Committee(s)'(s) conclusions and have to be responded to within the stated time frame.

Requests for updates of the product information should be addressed via a variation; a scientific justification for not submitting a requested variation should be submitted as a PAM.

When responding to these requests, the MAH should select "pam-leg" as submission type when filling in the eSubmission delivery file except for:

- Submission of final results of study involving paediatric patients submitted in fulfilment of Article 46 of the paediatric where the MAH should select the "pam-p46" when filling in the eSubmission delivery file.
- Provision of supplementary information to evaluate a signal or a scientific justification for not submitting a requested variation following a signal assessment, where the MAH should select "pam-sda" when filling in the eSubmission delivery file.

In accordance with the Paediatric legislation, MAHs should submit paediatric studies within six months of their completion and irrespective of whether it is part of a PIP (completed or not yet completed) or not, or whether it is intended for submission later on as part of a variation, extension or new stand-alone marketing-authorisation application.

### **References**

- Directive 2001/83/EC
- Regulation (EC) No 726/2004
- Questions and answers on signal management
- Submission of Article-46 paediatric studies: questions and answers
- Communication from the Commission — Guideline on the format and content of applications for agreement or modification of a PIP and requests for waivers or deferrals and concerning the operation of the compliance check and on criteria for assessing significant studies

### **15.6. What is a recommendation ['REC']? Rev. Apr 2015**

During the assessment of an application, the committee(s) may issue recommendations for further development of the medicinal product, e.g. either in terms of optimising some quality aspects or considerations for extending the patient population. Although these recommendations for further development are not binding to the marketing authorisation, they should be seen as important considerations in view of the potential future use of a medicinal product by the MAH.

This information can be submitted as a PAM however if data obtained in the framework of a recommendation has an impact on the authorised medicinal product and its product information, the MAH has the obligation to submit a variation application as appropriate (see: *How and to whom shall I submit my PAM data?*).

As such, the committee(s) will keep an overview of all recommendations made to a marketing authorisation and monitor whether, how and when the MAH has addressed them. Therefore, MAHs are encouraged to use the template for the cumulative letter of recommendations to acknowledge these recommendations.

MAHs should specify the following in their letter of recommendations:

- a clear and concise description of each post-approval recommendation;
- the procedure number where the recommendation was given.

No deadline needs to be mentioned.

When data in relation to a recommendation is provided to the Agency, an updated Letter of Recommendation should be provided, in which the MAH should indicate the date of submission and its format (e.g. as self-standing data, within a variation, within a renewal etc.).

#### **References**

- Directive 2001/83/EC
- Regulation (EC) No 726/2004

### **15.7. Can the classification of my PAM change during its lifecycle? Rev. Apr 2015**

New data or information regarding the medicinal product becoming available can result in the committee(s) considering that a PAM should be reclassified. Such reclassification will be performed within the procedure discussing the impact of the new information that has become available and will be justified in the assessment report where the measure is, as a consequence, up- or downgraded.

### **15.8. When shall I submit my PAM? Rev. Aug 2018**

The MAH shall submit the PAM data according to the timeframe specified by the Agency's committee(s) as specified either in the annex II, the RMP or the respective committee assessment. When requested, the MAHs should propose due dates for the submission of the post-authorisation data that are realistic and proportionate to the uncertainty to be addressed which are then subject to agreement with the Agency's committees.



Data submitted as PAM should be submitted as per the deadline specified by the Committee(s) and will start in accordance with the published submission dates for PAMs (see also Human Medicines - Procedural timetables / Submission dates). Assessment of PAM data submitted after the recommended submission date will start in accordance with the start date of the following month.

If the MAH is unable to provide the required data by the specified deadline, he must inform the Agency and the rapporteur in writing as early as possible in advance of the due time of submission. The reason for the delay must be justified and a new submission date proposed and is subject to agreement by the Committee(s). These submissions should be done as follows:

- Changes to the due date for a SOB, Annex II condition or category 3 study in the RMP should be submitted as type IB variation category C.I.11.z, include the updated RMP and/or product information as applicable.
- Changes to category 4 studies listed in the RMP can be updated in the context of any other RMP update.
- Proposals for changes to directly legally binding measures (LEG including SDA) have to be notified in writing, together with an appropriate justification, and have to be agreed as well by the Agency's Committee(s).
- In the case of a non-justifiable delay, the Agency's committees will consider taking regulatory action (see also next question).

#### References

- Directive 2001/83/EC
- Regulation (EC) No 726/2004
- Guidelines on the details of the various categories of variations, on the operation of the procedures laid down in Chapters II, IIa, III and IV of Commission Regulation (EC) No 1234/2008 of 24 November 2008 concerning the examination of variations to the terms of marketing authorisations for medicinal products for human use and veterinary medicinal products and on the documentation to be submitted pursuant to those procedures (Guidelines on Variations)

### **15.9. Under which procedure should I submit my PAM? *Rev. Jul 2021***

The procedure under which the PAM should be submitted will depend on the content and type of information submitted as part of the PAM, as summarised in the table below:

PAM	Submission	Procedure/Type of application
Specific obligation (category 2) [SOB]	Non-interventional PASS	See Post Authorisation Safety Study
	<ul style="list-style-type: none"> <li>• Protocol and substantial amendments</li> </ul>	Article 107n-o
	<ul style="list-style-type: none"> <li>• Interim results</li> </ul>	SOB
	<ul style="list-style-type: none"> <li>• Final results</li> </ul>	Article 107p-q

	Annex II E Interventional Efficacy Studies	
	<ul style="list-style-type: none"> <li>Protocol (where requested to be submitted)</li> </ul>	<p>Stand-alone PAM [SOB]</p> <p><i>Where a protocol is not requested to be submitted by the Agency's Committee, the MAH should consider to seek scientific advice</i></p>
	<ul style="list-style-type: none"> <li>Interim results</li> </ul>	<p>Conditional renewal, annual re-assessment</p> <p><i>(Note: if submission of interim results is requested outside of the timelines of the renewal or annual re-assessment, these can be submitted as stand-alone PAM, if no changes to the PI are proposed), alternatively a type II would be required.</i></p>
	<ul style="list-style-type: none"> <li>Final results</li> </ul>	<p>Conditional renewal, annual re-assessment or type II variation, depending on the timelines.</p>
Annex II condition (category 1) [ANX]	Non-interventional PASS	See Post Authorisation Safety Study
	<ul style="list-style-type: none"> <li>Protocol and substantial amendments</li> </ul>	Article 107n-o
	<ul style="list-style-type: none"> <li>Interim results</li> </ul>	ANX
	<ul style="list-style-type: none"> <li>Final results</li> </ul>	Article 107p-q
	Others studies (including PAES)	
	<ul style="list-style-type: none"> <li>Protocol (where requested to be submitted)</li> </ul>	<p>Stand-alone PAM [ANX]</p> <p><i>Where a protocol is not requested to be submitted by the Agency's Committee, the MAH should consider seeking scientific advice</i></p>

	Interim results <ul style="list-style-type: none"> <li>No changes to PI</li> <li>Changes to PI</li> </ul>	Stand-alone PAM [ANX] Type II variation
	Other studies: Final results	Type II variation
Additional Pharmacovigilance activity in the RMP (category 3) [MEA]	Protocol (as requested by Committee and reflected as a milestone in the RMP)	Stand-alone PAM [MEA] <i>Where a protocol is not requested to be submitted by the Agency's Committee, the MAH should consider seeking scientific advice</i>
	Interim results <ul style="list-style-type: none"> <li>No changes to PI</li> <li>Changes to PI</li> </ul>	Stand-alone PAM [MEA] Type II variation
	Final results	Type II variation
Legally binding measure [LEG] (including [SDA] and [P46])	Provision of data requested by the Committee (e.g. cumulative review, CAPA, interim study results) <i>([SDA] when related to a signal assessment)</i>	
	<ul style="list-style-type: none"> <li>with no changes to the PI</li> </ul>	Stand-alone PAM [LEG]/[SDA]
	<ul style="list-style-type: none"> <li>with PI changes</li> </ul>	Type II variation
	Final study report	Type II variation
	Justification for not submitting a variation <i>([SDA] when related to a signal assessment, otherwise [LEG])</i>	Stand-alone PAM [LEG]/[SDA]
	Submission of final results of study involving paediatric patients in accordance with Article 46 of the paediatric regulation [P46]	
	<ul style="list-style-type: none"> <li>No changes to PI</li> </ul>	Stand-alone PAM [P46]
	<ul style="list-style-type: none"> <li>Changes to PI</li> </ul>	Type II variation
Recommendation [REC]	Interim results <ul style="list-style-type: none"> <li>No changes to PI</li> </ul>	Stand-alone PAM [REC]

	<ul style="list-style-type: none"> <li>Changes to PI</li> </ul>	Type II variation
	Final results	Type II variation
	ERA study results with no impact to PI	Type IB CI.z variation
Recommendation [REC] - Quality	No changes introduced to Module 3 (confirmatory data e.g. confirmatory stability data (without claiming a change in shelf-life/ in-use shelf-life or storage conditions))	Stand-alone PAM [REC]
	Changes introduced to Module 3	Respective variation as per the Variation Classification Guideline

Where the deliverable of a measure is submitted as part of another procedure, the structure of the submission package should follow the requirements of this procedure and the MAH should indicate in the cover letter of the application which PAM is being addressed, including the EMA reference number and the full description of the relevant PAM. The PAM submission form does not need to be included in the variation submission package. The MAH does not need to submit a separate 'stand-alone' submission of the PAM data.

#### References

- Directive 2001/83/EC
- Regulation (EC) No 726/2004
- EMA post-authorisation procedural advice - variations
- Guidelines on the details of the various categories of variations, on the operation of the procedures laid down in Chapters II, IIa, III and IV of Commission Regulation (EC) No 1234/2008 of 24 November 2008 concerning the examination of variations to the terms of marketing authorisations for medicinal products for human use and veterinary medicinal products and on the documentation to be submitted pursuant to those procedures (Guidelines on Variations)

#### **15.10. How shall I structure my PAM submission dossier? Rev. May 2020**

The Agency will check PAM submissions with respect to the Guidelines on Variations to ensure that it does not fall within one of the classifications. In this regard, the Agency will reject any PAM submission that should be filed as a variation application. In such cases, the eCTD submission of the variation application should provide a reference to the PAM eCTD submission for this sequence to be closed. Where the MAH is requested to resubmit as a variation application, the start of the variation procedure will be upon receipt of the complete application according to the next upcoming starting date as per published timetable for Type II.

'Stand-alone' PAM submission must include:

- a cover letter and a duly completed eSubmission delivery file to facilitate registration

- A completed PAM submission form with the full description and reference number of the PAM – as available. (The number to be quoted is the number attributed by the Agency at the time of adoption of the PAM including - for SDAs - the EPITT number). The description should mention the due date, including any agreed extension of it. This form will ensure the correct classification of the submission, involvement of designated Committees(s) and timetable to be applied.
- All supportive documentation relevant to the fulfilment of the PAM should be presented in accordance with the appropriate headings and numbering of the European Common Technical Document (EU-eCTD) format.
- Any scientific advice or protocol assistance obtained in relation to the fulfilment of PAMs concerned should be included.

## References

- PAM submission form
- EMA post-authorisation procedural advice - variations
- Regulatory and procedural guidance on dossier format

### **15.11. How and to whom shall I submit my PAM data? *Rev. Feb 2019***

Information is available on 'Submitting a post-authorisation application'.

### **15.12. How shall my submission of PAM be handled (timetable), and what could be the outcome of the evaluation? *Rev. Jul 2021***

This section only applies to submissions of PAM data as a 'stand-alone' submission.

Most PAMs will be evaluated by CHMP (and CAT if an advanced therapy medicinal product).

However, PRAC will lead the review of protocols or interim results of non-interventional safety studies and in any follow-up PAM to a procedure primarily assessed by PRAC (e.g: cumulative safety review requested further to the assessment of PSUR [LEG] or a signal [SDA]).

PAMs will be handled using one of the three timetables:

- CHMP led PAM assessment timetable
- PRAC led PAM assessment timetable
- Urgent PRAC led PAM assessment timetable, e.g. for urgent signal PAMs [SDA]

The submission deadlines and full procedural detailed timetables are published as a standard calendar on the EMA website (see: Human Medicines – Procedural Timetables / Submission dates).

The Agency will send to the MAH the final assessment report after CHMP adoption. The following outcome may be envisaged depending on the committee's conclusion:

- the PAM is fulfilled and no further action is required;

- the PAM is not yet fulfilled, as further clarifications or additional data are required. A request for supplementary information to be addressed by the MAH within a given timeframe will be issued and a follow-on PAM (such as MEA 00X. 1) created. The PAM will only be considered as fulfilled, once all requests for supplementary information have been addressed by the MAH to the Agency's committees' satisfaction;
- PAM is fulfilled but follow-up regulatory action is required, e.g. a request for variation and this will result in a new PAM being issued.

#### **References**

- Directive 2001/83/EC
- Regulation (EC) No 726/2004

### **15.13. Do I have to pay fees for the PAM data submission? *Rev. Apr 2015***

There is no fee payable for a PAM stand-alone submission.

### **15.14. How are PAMs enforced? *Rev. Feb 2019***

The Agency will keep a record of the post-authorisation measure and its due date in its database. In addition, the compliance with specific obligations is assessed annually, as part of the annual renewal (for conditional marketing authorisations) or annual reassessment (for marketing authorisations under exceptional circumstances).

In case of overdue measures or a MAH being found non-compliant in satisfying a post-authorisation measure, the responsible committee will consider the need for appropriate actions to be taken including involvement of the relevant committee(s).

In such situations, the rapporteur (or a lead rapporteur nominated by the committee in case of more than one affected product) may draft an assessment report on the impact of the lack of data on the benefit/risk balance of the affected product or other analysis to support a discussion on the next steps by the Agency's committee(s). Based on the outcome of such assessment and/or discussion, one or more of the following actions may be taken:

- letter to the MAH by the chair of the committee
- oral explanation by MAH to the committee
- initiation of a referral procedure with a view to vary/suspend/revoke the MA in light of art. 116 of Directive 2001/83/EC
- inspection to be performed upon request of the committee(s).

Furthermore, according to Article 20a of Regulation (EC) No 726/2004, a conditional marketing authorisation shall be varied, suspended or revoked if it is concluded that that the MAH has failed to comply with the obligations laid down in the conditional marketing authorisation.

Such regulatory action in regards to non-compliance of a MAH may be made public by the Agency on the Agency website e.g. in the EPAR(s) of the affected product(s).

Irrespective of the above regulatory actions, the Agency may take at any point in time a decision to take another enforcement action beyond those described here.

#### **References**

- Directive 2001/83/EC
- Regulation (EC) No 726/2004

#### ***15.15. Will there be any publication on the outcome of my PAM? Rev. Apr 2015***

Outcome of PAMs are not published in the EPAR 'Procedural steps taken and scientific information after the authorisation'. However, assessment reports for data submitted in accordance with Article 46 of the paediatric regulation and PRAC recommendations on signals are published on the Agency's website.

#### **Reference**

- EPARs

#### ***15.16. Who should I contact if I have a question when preparing my application? Rev. Apr 2019***

If you cannot find the answer to your procedural question in the post-authorisation measures: question and answers when preparing your application, please contact your Product Lead.

#### ***15.17. Who is my contact at the European Medicines Agency during post-authorisation procedures? Rev. Feb 2019***

Information is available on 'Submitting a post-authorisation application'.

## 16. Risk Management Plan

This page is intended to provide advice to Marketing Authorisation Holders of centrally authorised medicinal products about procedural and regulatory aspects to the Risk Management Plan (RMP) lifecycle during the post authorisation phase. It addresses the classification of changes to the RMP, submission requirements and aspects to be considered in the management of parallel procedures affecting RMP. Revised topics are marked 'New' or 'Rev.' upon publication.

A PDF version of the entire post-authorisation guidance is available: European Medicines Agency post-authorisation procedural advice for users of the centralised procedure.

It should be read in conjunction with the Guideline on good pharmacovigilance practices – Module V – Risk Management Systems (Rev 1) and the European Commission 'Variations Guidelines' 2013/C 223/01.

MAHs must in all cases comply with the requirements of Union legislation.

### **16.1. When should I submit a new/updated RMP? *Rev. Dec 2017***

A new RMP or an update of the RMP, as applicable, may need to be submitted at any time during a product's lifecycle.

Since July 2012, all new marketing authorisations (MAs) applications should include an RMP. However, as the provision of an RMP was not mandatory before that date, there are still MAs for some centrally authorised products without an RMP. It should be noted, however, that for these products without RMP there are situations (e.g. new safety concerns, significant changes to the MA) that may trigger the need to introduce an RMP.

For medicinal products with an RMP, whenever new data are provided as part of a regulatory application in the post-authorisation setting, the MAH should consider whether consequential significant changes to the RMP are needed. Should this be the case, a revised RMP should be included as part of the regulatory application as it is the responsibility of the MAH to update the RMP whenever new information is being received that have a significant impact on the content of the RMP.

An RMP update is expected to be submitted at any time when there is a change in the list of the safety concerns or when there is a new or a significant change in the existing additional pharmacovigilance or additional risk minimisation activities. For example, a change in study objectives, population, due date of final results, a due date for protocol submission for an imposed study, or addition of a new safety concern in the key messages of the educational materials would be expected to be reflected in an updated RMP with the procedure triggering those changes. The significant changes of the existing additional pharmacovigilance and risk minimisation activities may include removing such activities from the RMP.

An update of the RMP might also be considered when data submitted in the procedure results or is expected to result in changes of routine pharmacovigilance activities beyond adverse reaction reporting and signal detection activities, or of routine risk minimisation activities recommending specific clinical measures to address the risk. For example, an RMP update might be warranted with a significant change of the plans for annual enhanced safety surveillance (routine pharmacovigilance activity), or when monitoring of renal function is added as a recommendation in the *Special warnings and precautions for use* section 4.4 of the SmPC (routine risk minimisation activity). The need to update



the plans to evaluate the effectiveness of risk minimisation activities should also be considered with such updates.

When an emerging safety issue is still under assessment (as defined in GVP Module VI), in particular in the context of a signal or potential risk that could be an important identified risk, an RMP update may be required if the emerging safety issue is confirmed and the important identified or potential risk requires to be added to the list of safety concerns in the RMP.

The need for an update to the RMP or a new RMP, including procedural aspects, should be discussed with the Agency, as appropriate, well in advance of the submission of an application, and in particular when involving a significant change to an existing marketing authorisation and/or parallel procedures warranting an RMP update.

## **16.2. When is my RMP a stand-alone variation? Rev. Dec 2017**

It is expected that for RMP updates which are consequential to the data provided in a regulatory application, the updated RMP should be provided as part of the same application (see also Question 4 below). However, if an RMP needs to be updated outside any regulatory procedure, this RMP should be submitted as a stand-alone variation.

A stand-alone variation for updates of the RMP may be foreseen or requested by the Agency in particular in the following situations:

- In case of changes to the safety concerns outside another procedure; for instance, if interim results of a study assessed as a post-authorisation measure (PAM) lead to changes in the safety specifications (i.e. the need to add, delete or reclassify safety concerns);
- As a follow-up of a PSUR or signal procedure.

RMP updates cannot be accepted together with the PSURs of medicinal products (centrally and/or nationally authorised) subject to a PSUR EU single assessment (PSUSA), unless the PSUSA procedure includes only CAPs which are part of the same global MA (e.g. duplicate MAs). MAHs should update their RMP through another upcoming procedure affecting the RMP or alternatively, through a separate variation which can be submitted after finalisation of the PSUSA procedure;

- In case of proposed changes to already previously agreed category 3 studies in Part III.4.3 of the RMP. This applies also when the MAH has provided an updated / amended protocol that has been assessed via the PAM procedure and which has an impact on the description of the study in Part III.4.3.

## **16.3. What if my application does not include an updated RMP? Rev. Dec 2017**

If the MAH considers that no update of the RMP is warranted at the time of submission of a regulatory application following the assessment of the application, the PRAC/CHMP may or may not agree with the view that no RMP changes are warranted. If not agreed, the MAH will be requested to provide an updated RMP in response to a CHMP Request for Supplementary Information (RSI) during the procedure.

It is essential to always strive to conclude the RMP assessment during the procedure i.e. a final updated RMP version should be provided for agreement prior to the CHMP Opinion. However, if the PRAC/CHMP agrees that the requested update may not be possible during the procedure taking the procedural timelines into account, the RMP can instead be updated at the 'next regulatory opportunity', i.e. as part of the next application or as a stand-alone variation.

In this regards, if relatively minor RMP changes are requested by PRAC/CHMP for implementation at the 'next regulatory opportunity', the changes can be included as part of another appropriate regulatory procedure under a single scope (e.g. as part of a type IB variation or type II variation affecting the RMP without the need for an additional specific variation(s)) (see also Question 5 below). However, in the situation where additional data and significant further assessment is still necessary, this requires a separate type II variation regardless of whether it is submitted as a stand-alone variation application or part of a grouped application.

## **16.4. Which variation classification will apply for my RMP updates? *Rev. Aug 2020***

### **16.4.1. Consequential RMP updates**

All RMP changes are in principle considered as changes to the MA and therefore require the submission of a specific variation. However, when the RMP updates are *consequential* to the data provided in an application, the updated RMP should be included as part of the same application. The latter is frequent for type II variations submitted under categories C.I.4 or C.I.6 when the product information is affected, type II variations under category C.I.13 when a final study report is provided without any impact on the product information, for line extension applications, renewals of MA and for PSURs when the proposed update is related to the data submitted in the PSUR.

In addition, in case of changes to the Annex II conditions either proposed by the MAH or resulting from the assessment, e.g. safety study in Annex II D or E or additional risk minimisation measures in Annex II D, the MAH should also implement consequential changes to the RMP as part of the same application/procedure.

### **16.4.2. Variation classification categories for stand-alone RMP updates**

#### **Type II C.I.11.b**

- Introduction of a new RMP outside another regulatory procedure.
- Addition, modification or deletion of safety concerns (identified risks, potential risks, missing information) not previously assessed and agreed by the EMA (e.g. with signals, PSURs).
- Changes to agreed post-authorisation studies in the RMP, if there is an impact on the description of the study (objectives as given in the summary table of on-going and planned additional pharmacovigilance activities, excluding changes to due dates) and/or to risk minimisation measures in the RMP not previously assessed and agreed by the EMA;

e.g.:

- Study objective: e.g. no more hypothesis testing.

- Study population: type or number, if it may restrict the objective; e.g. considerable sample size reduction; decrease in centres or geographical spread.
- Study design: e.g. follow-up type; passive versus patient diary.

### **Type IB category C.I.11.z**

- Updates of RMPs not falling within the scope of type II variations (see above) are in principle type IB variations.
- Addition, modification or deletion of a safety concern (identified risks, potential risks, missing information) which has already been assessed and requested by the PRAC/CHMP in a previous procedure; i.e. the changes have already been formally assessed and agreed in principle as part of a previous procedure (e.g. assessment of signals, PSURs, variations, PAMs) by the PRAC/CHMP, although the agreement on the exact wording to be implemented in the RMP is still pending and further assessment is therefore required.

Note: In order for the implementation of pre-agreed RMP changes to be handled as a type IB variation, no additional data should be needed or submitted to support the proposed changes.

- Change to the final due date i.e. the date for the provision of the final study report for category 1, 2 or 3 studies in the RMP and/or the Annex II, as relevant.
- Changes of a due date for protocol submission for an imposed study.

Note: Because no specific changes are identified by the variations classification guideline as falling by default into the type IB variation category, the above changes lead to such variation only when they constitute the reason for submitting the updated RMP. In case the MAH takes the opportunity to propose such changes with an RMP update undertaken for another reason (e.g. as part of a type II variation), these changes are accepted as minor and do not trigger additional variation scopes (please refer to Question 5 below).

### **Type IA<sub>IN</sub> category C.I.11 a)**

- Implementation of changes to the conditions based on an exact wording agreed by PRAC/CHMP without any further changes, provided that no linguistic review of translations is required in case of simultaneous changes to the Annex II (i.e. deletion of information, changes to timelines are acceptable but not the implementation of new wording as such).
- Update of the RMP in response to a request following signal detection provided an exact wording agreed by PRAC/CHMP is implemented without further changes.
- Update of the RMP in response to a request following assessment of a protocol of a category 1,2 or 3 study provided an exact wording agreed by PRAC/CHMP is implemented without further changes.

Note: The changes to be implemented must already have been assessed by the Committee(s) in a previously concluded procedure; only the exact agreed wording is implemented, no additional changes are proposed and no further assessment is required.

However, it should be noted that it is rare that an exact wording is pre-agreed and therefore in most cases a type IB or type II variation will be required. Regardless, the MAH should always specify in the submission whether or not the proposed changes have already been assessed, and if so, as part of which procedure.

### **16.5. Which changes can be included in an RMP update without the need for an additional variation? Rev. Dec 2017**

It is in principle acceptable to take the opportunity of a regulatory application (e.g. a type IB or type II variation) which warrants an update of the RMP to implement also:

- minor administrative changes to the RMP;
- template-related updates (e.g. from RMP template rev. 1 or rev. 2);
- updates of clinical / post-marketing data (e.g. exposure data and data coming from important clinical trials without impact on key safety information or final due dates);
- changes to category 4 studies listed in table III.4.4 (stated additional pharmacovigilance activities, also known as 'REC'= Recommendation) (only from RMPs using rev. 1 of the RMP template);

as long as the proposed changes are not affecting the summary of the safety concerns, the summary table of additional pharmacovigilance activities, the routine risk minimisation activities recommending specific clinical measures to address the risk or additional risk minimisation activities.

Further, in the event that relatively minor RMP changes are requested by PRAC/CHMP for implementation at the 'next regulatory opportunity', i.e. as part of the next application resulting in more substantial changes to the RMP (e.g. type IB variation, type II variation, line extension, renewal), these changes can be included as part of the next upcoming RMP update under a single scope i.e. without any need for an additional specific variation, unless there is a defined timeframe by when the update is requested and there is no other planned major RMP update in the same timeframe.

### **16.6. Can I group my RMP updates? Rev. Dec 2017**

Each proposed 'major change' to the RMP triggers in principle its own type II variation scope. It should be noted that one specific type II variation is required for each scope even when submitted together with other major changes as part of a grouped variation application. The same rules apply to the grouping of major RMP changes as to the grouping of any other (non)clinical type II variations:

- changes meaningful to be reviewed simultaneously can be grouped;
- non-clinical and clinical safety changes are not accepted as part of the same grouping;
- and grouping should not delay the implementation of important changes (for instance a proposed extension of indication should not be grouped with safety variations).

With regard to multiple 'minor changes' which can be assessed as type IB variations if submitted on their own, these do not require a grouped application; instead it is acceptable to include these minor changes as part of one single type IB variation or type II variation without the triggering of additional type IB variation scopes i.e. any need for additional variations (see also Question 5 above).

The following cases are meant to illustrate how these rules would be applied for RMP updates:

#### *Example 1*

Addition of a new Adverse Drug Reaction and a relevant warning to the SmPC via a type II variation C.I.4 with consequential update of the list of important identified risks in the RMP and submission of a

final study report for a category 3 study in the RMP via a type II variation C.I.13 with consequential updates of the RMP (i.e. removal of the study from the Pharmacovigilance Plan). This can be submitted as a grouped application of 2 type II variations.

#### *Example 2*

Submission of a final study report for a category 3 study via a type II variation C.I.13 with consequential updates of the RMP, and:

- Deletion of the category 3 study in the RMP – no need for separate variation since related to the main application;
- Addition of a safety concern in the RMP following a request from PRAC as part of a PSUR assessment – 1 (grouped) Type II category C.I.11.b if additional data are submitted and/or further significant assessment is required; no need for a separate variation otherwise as the change is implemented as part of a type II variation affecting the RMP;
- Changes to the due date for the provision of the final study report for a category 3 study in the RMP – no need for a separate variation as the change is implemented as part of a type II variation affecting the RMP;
- Update of the RMP with significant changes of the clinical trial exposure – can be implemented within the variation without the need for an additional variation.

#### *Example 3*

Changes to the due date for the provision of the final study report for two category 3 studies in the RMP.

This can be submitted as a single type IB variation under category C.I.11.z.

On the other hand, a grouped application is generally not acceptable if it creates the risk of postponing the implementation of important safety information in the RMP:

#### *Example 4*

- In case a type II variation is submitted under category C.I.6 (Extension of Indication), the RMP version submitted as part of this application should include changes that are consequential to the new data provided and the new proposed indication, and it can also include changes that have been previously assessed and agreed. As the procedure for an extension of indication application may take some months to finalise, other non-related changes that require assessment should not be included and/or grouped with an extension of indication application (e.g. the implementation of safety information should not be delayed).

### **16.7. How should I handle parallel RMP submissions? Rev. Dec 2017**

There is only one approved RMP at any time for a medicinal product. Consequently, any time an updated RMP is approved as part of a procedure (e.g. variation, renewal, PSUR), this RMP becomes the approved RMP of the product, and any previous version becomes obsolete. Therefore, MAHs should carefully consider the planning of RMP submission, to make sure that the approved RMP always contains the most up-to-date information on the pharmacovigilance planning and risk minimisation measures.

Given the content-based requirements for RMP submission, it is expected that there will be only few procedures where an RMP update should be included. The MAH should consider whether an RMP is really required with the procedure that is in preparation for submission. Early discussion with the regulators should facilitate the submission, to avoid unnecessary RMP submissions and assessment; parallel procedures warranting RMP updates should be avoided as much as possible.

MAHs are strongly encouraged to streamline RMP amendments and submissions, in co-operation with the EMA for the centrally authorised products, in order to facilitate RMP assessments throughout the product lifecycle.

There are two alternative approaches to the handling of different RMP versions for which the assessment is over-lapping, and the MAH should choose the option that facilitates the assessment taking into account anticipated timelines for the finalisation of the procedures.

Whenever separate applications affecting the RMP are submitted in parallel, in order to facilitate the review, it is generally agreed that the MAH initially and whenever appropriate during the procedure submits one joint draft RMP file as a 'working document'. This single RMP document should include all data consequential to the concerned procedures running in parallel. To facilitate the assessment, the proposed RMP changes should be marked (e.g. with different colour code), to differentiate changes specific to each procedure (example: new safety concerns derived from an extension of indication in a new population should be marked differently from the changes in the Pharmacovigilance Plan consequential to (early) termination of a study and initiation of another one as a consequence of the limited safety data gathered in the ended study).

If the parallel applications reach the finalisation stage at the same time, the consolidated RMP version will be adopted by the relevant Committee and will become the approved version of the RMP.

If the applications do not reach the finalisation-stage at the same time, at the time of the first opinion for the parallel procedures, the MAH will need to provide for review and approval a final RMP version including only the agreed changes related to the scope of the variation application for which the CHMP is about to adopt an opinion. The joint RMP 'working document' will continue to be used in the context of the remaining ongoing procedure(s).

Example: A safety variation is triggered whilst an extension of indication procedure is ongoing, both requiring significant changes in the RMP (new safety concern in the new indication; another safety concern and a new imposed PASS in the safety variation). The RMP for the safety variation can be built upon the RMP document submitted with the extension of indication.

**Option A:** A joint RMP document including changes relevant to both procedures could be submitted with both the responses to the RSI in the extension procedure, and with the initial submission for the safety variation:

- If both procedures reach the Opinion stage at the same time, then the joint RMP will be adopted and become the approved RMP.
- If however the extension of indication requires a second RSI, and is most likely to be finalised after the parallel safety variation, the MAH will then have to submit before the opinion for the safety variation an RMP including only the safety concern and the new study related to the safety variation data. This version of the RMP will be checked for consistency and approved with the safety variation opinion. The updated joint RMP 'working document', including the changes consequential to the responses to the second RSI for the extension of indication will continue to be

assessed within the extension of indication procedure. This joint RMP will be considered the approved RMP once the extension of indication variation reaches opinion.

A graphical representation for option A is included below:

RMP initially included with the extension of indication



**New data related to the extension of indication**

Joint RMP included with the safety variation



**New data related to the safety variation**

If both variations reach opinion the same month:



**RMP approved with both procedures**

If safety variation reaches opinion first:



**RMP approved with safety variation**



**RMP approved with extension of indication**

*Option B:* Alternatively, it might be more appropriate when parallel procedures will follow very different assessment timetables to opt for an approach similar to the handling of parallel procedures with product information changes; the RMP submitted with each procedure should only include the changes related to that procedure:

- an updated version of the RMP is submitted as a type II variation to reflect the changes in the safety profile derived from post-marketing reporting. This RMP version should include only the changes related to the RMP update.
- subsequently or at the same time, another RMP update is submitted as part of a type II variation for the extension of indication. For this application, the RMP version only includes the changes that are consequential to the extension of indication (i.e. not the changes related to the safety variation).

If both procedures conclude at the same time, the MAH is expected to merge the two RMP documents for approval by the opinion time.

If the RMP update variation is approved before the extension of indication procedure, the RMP submitted will be adopted with the relevant changes and the MAH can submit a consolidated RMP version as part of the MAH's responses to an RSI for the extension of indication. This RMP version includes then the changes approved as part of the recently finalised safety variation (as clean text) as well as the changes related to the extension of indication (with track changes).

The option B can be illustrated as follows:

RMP included and approved with the type II variation if reaching opinion first (PM RMP update)



**Data submitted with the RMP update (Type II)**

RMP included with the extension of indication



**New data related to the extension of indication**

RMP approved when procedures reach opinion in the same month:



**RMP approved with both procedures finishing the same month**

After the PM RMP variation is approved, the RMP included in the responses to the extension of indication RSI (to be approved with the opinion for the extension of indication):

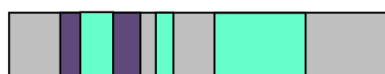

**RMP approved with extension of indication**

Regardless of the approach chosen, the MAH should always provide a clear description of the scope(s) of the submission in the cover letter and the changes implemented in the RMP including references to related (previous/parallel) regulatory procedure(s) (see also Question 8 below).

## **16.8. How shall I present my RMP update? Rev. Oct 2019**

Guidance on the format and content of the RMP as outlined in GVP module V and RMP template has been made available in the Pharmacovigilance section of the Agency's website. The submitted RMP should follow the RMP template and guidance.

The RMP should be provided in CTD section 1.8.2. RMP versions submitted for assessment should be version controlled and dated. All parts and modules of the RMP should be submitted in one single PDF-file so that a complete RMP is provided to the Agency.

Only clean versions of documents in PDF format should be managed within the eCTD lifecycle. However, due to the fact that additional formats are required to facilitate the assessment i.e. 'tracked changes' versions for SmPCs, RMPs or other documents as specified by the agency, these should be provided in Word format in the separate folder 'XXXX-working documents'. Further details in this regard can be found in section 2.9.9 of the Harmonised Guidance for eCTD Submissions in the EU. It is generally not necessary to include the annexes as part of the RMP 'working document' unless any of the annexes are actually revised. If no tracked changes version can be compiled (e.g. due to template transition when the tracked changes would be significant throughout the document), a 'clean' Word version file of the RMP should still be submitted in the 'XXXX-working documents' folder; this will facilitate the preparation of the RMP Summary to be published on the Agency website.

In general, any submitted version of the RMP should be based on the latest approved version (i.e. the latest version agreed by CHMP). However, sometimes it may be more appropriate to base the next version to be submitted on the latest RMP 'working document' version, especially when several procedures affecting the RMP are ongoing in parallel (see Question 7 above).

Regardless, the submitted RMP version should be seen as a draft, until approved. Details of the RMP approval status should be provided in the Module I of the document. The revised RMP should always



get a new version number every time an updated RMP version is submitted for assessment (see recommendations on document versioning in the *Guidance on the format of the risk management plan (RMP) in the EU – in integrated format*).

When relevant, a discussion of the proposed RMP changes should be included in the (non-) clinical overview (addendum). It should be noted that the provision of a (non-)clinical overview (addendum) is mandatory as part of a (non-)clinical type II variation application which includes a revised RMP regardless of the fact that there may be no impact on the product information. In this case the (non-) clinical overview (addendum) should discuss and justify the proposed RMP changes. On the other hand, a (non-) clinical overview (addendum) is never required as part of type IA and type IB variation applications.

In the EU application form (AF) and for (non-)clinical variations, the "Present/Proposed" table will in general only reflect proposed changes to the EN Annexes (SmPC, Annex II, labelling and Package Leaflet). It is not foreseen that the updates to the RMP are reflected in the AF in detail unless quite limited in scope. Instead, when comprehensive changes to the RMP are proposed, it is recommended to provide a comparative table of the RMP (latest agreed version vs. proposed version), summarising – for all individual RMP parts and modules – the main updates. For example, all changes linked to the implementation of a new template can be summarised as 'new RMP template'. Such comparative table should be provided as an annex to the AF.

### **16.9. Can I submit a version of the RMP after the Opinion to reflect the last minute changes made during the CHMP? Rev. Dec 2017**

As a matter of principle the day of the CHMP Opinion/EMA Notification is the last opportunity for the MAH to provide an updated version of the RMP (in word format) for agreement. The same RMP version with the same version number – without any additional changes - can thereafter be submitted as part of a formal eCTD closing sequence post-opinion. However, if additional changes to the RMP are identified post-opinion after receipt of the document, an updated RMP version with a new version number should be provided for review as part of a type IB variation under category C.I.11.z.

The same principles apply also in situations when there are different RMP versions undergoing assessment in parallel and concluding the same month (see also Question 7 above). MAHs are requested to provide the final consolidated RMP version (in word format) before the date of the CHMP Opinion/EMA Notification.

### **16.10. Is the PRAC Rapporteur involved in the assessment of RMP updates?**

The PRAC Rapporteur will be involved in the assessment of all variations that include an updated RMP. For type IB variation including RMP, PRAC Rapporteur will be in the lead of the assessment. For type II variations, the CHMP or PRAC may take the lead during the assessment depending on the composition of the data provided, and this will be decided on a case-by-case basis at the time of the EMA validation.

Similarly, on a case-by-case basis, the PRAC Rapporteur may also later become involved in the assessment of an application if requested by the CHMP during the procedure.

At the time of validation the Agency will inform the MAH of the involvement of the PRAC Rapporteur through the assessment timetable which will refer to the relevant assessment reports expected from the PRAC Rapporteur, as appropriate.

### **16.11. How long after the European Commission decision should Annex 1 of the RMP be submitted to EudraVigilance? *Rev. Jan 2021***

The maintenance of the Agency's database for RMP Annex I files ('Annex I tool') has been suspended as part of the Agency's Business Continuity Planning (BCP) caused by the COVID – 19 pandemic. Following this decision, as of 4<sup>th</sup> December 2020 the Marketing Authorisation Holders for centrally authorised products will no longer be required to create and submit RMP Annex I (.xml) files to the EMA.

Development and integration of a new database for structured electronic representation of the EU risk management plan to replace Annex I tool is pending BCP and the Agency's digitalisation strategy. Any announcements about the system replacing the RMP Annex I database, reinitiating the requirements for the submissions, or otherwise instructions about the submissions of RMP in a structured electronic format will be provided (i.e. via the Agency website or directly to MAHs) as appropriate, in due time.

### **16.12. How and to whom shall I submit my RMP application? *Rev. May 2020***

As explained in the hereby questions and answers on RMP, the RMP update can be submitted either as part of a procedure driven by another main change defining the procedure classification (e.g. extension of indication, new formulation, etc.) or as a stand-alone variation exclusively including the RMP. In the latter, the variation can be either a type II, type IB or type IA, see question 'Which variation classification will apply for my RMP updates?' for further guidance.

Irrespective whether the RMP update is consequential to another change or a stand-alone update, the RMP document follows the eCTD life-cycle management and should be provided in Module 1.8.2 of the eCTD structure. Submission of the RMP should be made according to the framework of the procedure to which it belongs to and should follow the requirements and technical process for this procedure. More information is available on 'Submitting a post-authorisation application'.

The use of the eSubmission Gateway or Web Client is mandatory for all electronic Common Technical Document (eCTD) submissions through the centralised procedure. The European Medicines Agency (EMA) no longer accepts submissions on CD or DVD. This applies to all applications for human medicines.

### **16.13. What templates should I use for the RMP submission? *NEW Dec 2017***

Depending on the application submission date, either the Revision 1 or the Revision 2 version of the Guidance on format of the risk-management plan in the European Union should be used including for generics. The Rev. 2 version is also applicable to generics as it includes specific guidance to generics. The transitional arrangements for the RMP submission are presented in the table below.

Acceptable template revisions to be used for RMP submissions:

<b>RMP submission with:</b>	<b>01.10.2017 – 30.03.2018</b>	<b>On and after 31.03.2018</b>
Any post-marketing procedure (initial submission or with responses to a RSI)	Rev.1 or Rev.2	Only Rev.2

RMPs submitted using Rev. 1 of the template instead of Rev.2 will not be rejected at validation of the submission, but will automatically trigger an additional step of assessment and an outstanding issue; applicants and MAHs will be required to update the RMP using the Rev.2 of the template and submit it with the responses to the RSI.

#### **16.14. When and how will the RMP Summary be published on the EMA website? *NEW Dec 2017***

All post-authorisation RMP updates using *Guidance on the format of the risk management plan (RMP) in the EU – in integrated format (Rev. 2)* leading to the RMP Summary update will trigger the publication of the RMP Summary.

The RMP Summary will be reviewed during the procedure under RMP Part VI and will be approved as part of the agreed RMP.

Post-opinion, the MAH will be asked to extract the RMP summary as a stand-alone PDF document and send it via EudraLink to the EMA. The PDF document should not contain meta-data, headers or footers related to the overall RMP document, nor excessive formatting.

The extracted PDF RMP Summary will be published on the EMA website at the time of the EPAR update, on the product's page (EPAR summary landing page).

#### **16.15. How should I compile the list of safety concerns in the RMP for generic products when the originator products have an RMP? *NEW Apr 2019***

When the MAH / Applicant for a generic medicinal product submits an RMP for assessment, the safety concerns should be aligned to those of the originator product that are available either from the originator's approved RMP or from the list of safety concerns of the substance published on the CMDh website. Any divergence introduced in the RMP of the generic product (e.g. new safety concerns) should be thoroughly justified based on either differences in products' characteristics (e.g. excipients), or on compelling data generated with this generic product that would warrant a difference in the list of safety concerns in the RMP (e.g. clinical trial or post-marketing epidemiological study data). This justification should be detailed in Module SVII of Part II of the RMP.

This guidance also applies on other types of marketing authorisations with similar RMP requirements: hybrid products and fixed combination products with no new active substance.

#### **References**

- Directive 2001/83/EC

- Regulation (EC) No 726/2004
- Commission implementing Regulation No 520/2012 of 19 June 2012 on the performance of pharmacovigilance activities
- Guideline on good pharmacovigilance practices – Module V – Risk Management Systems (Rev 1)
- RMP template
- European Commission Guidelines on the details of the various categories of variations, on the operation of the procedures laid down in Chapters II, IIa, III and IV of Commission Regulation (EC) No 1234/2008 of 24 November 2008 concerning the examination of variations to the terms of marketing authorisations for medicinal products for human use and veterinary medicinal products and on the documentation to be submitted pursuant to those procedures

## 17. Periodic Safety Update Reports (PSURs)

### 17.1. What is a Periodic Safety Update Report (PSUR)? *Rev. Sep 2014*

Periodic safety update reports are pharmacovigilance documents intended to provide a safety update resulting in an evaluation of the impact of the reports on the risk-benefit balance of a medicinal product. They shall be submitted by marketing authorisation holders at defined time points during the post-authorisation phase.

The legal requirements for submission of PSURs are established in the Regulation (EC) No 726/2004 and the Directive 2001/83/EC.

The format of PSURs shall follow the structure described in the Commission implementing Regulation (EU) No 520/2012.

Further details and guidance for the submission of PSURs in the EU, including the list of Union references dates and frequency of submission are provided in Module VII "Periodic safety update report" of the guideline on good pharmacovigilance practices (GVP) and in the following questions and answers.

#### References

- Regulation (EC) 726/2004
- Directive 2001/83/EC
- Commission implementing Regulation (EU) No 520/2012 on the performance of pharmacovigilance activities
- Guideline on good pharmacovigilance practices (GVP) – Module VII – Periodic safety update report
- European Commission Question and Answers on transitional arrangements concerning the entering into force of the new pharmacovigilance rules
- EMA - HMA Questions and answers on practical transitional measures for the implementation of the pharmacovigilance legislation
- ICH guideline E2C (R2) Periodic benefit-risk evaluation report (PBRER)
- Guideline on good pharmacovigilance practices, Annex I - Definitions

### 17.2. What is the scope of PSUR assessment under the EU single assessment? *Rev. Mar 2017*

The Pharmacovigilance Risk Assessment Committee (PRAC) is in charge of issuing recommendation on the PSUR assessment for a single centrally authorised product and of the EU PSUR single assessment.

The EU PSUR single assessment, referred also as PSUSA, is the assessment of PSURs for medicinal products subject to different marketing authorisations containing the same active substance or the same combination of active substances and for which the frequency and dates of submission of PSURs have been harmonised in the list of EU reference dates (referred also as EURD list). These PSURs will be jointly assessed by the PRAC or a Member State appointed by the CMDh and result in one single assessment report, which will be shared amongst all the marketing authorisation holders (MAHs)

whose medicinal product(s) are part of the PSUR single assessment procedure. It should be noted that the responsibility for the quality of the submitted documentation lies with the MAH(s) and is crucial to the overall assessment. The data presented in the submissions should be intended exclusively for the purposes of the concerned procedure. The information and data contained in the individual submissions will be assessed and reflected in the single assessment report. Such information and data will not be redacted from the single assessment report with respect to individual products prior to sharing them with all concerned MAHs. Indeed, PSUR related data presented in agreement with GVP module VII on PSURs as such are not considered to be commercially confidential. Of note, MAHs cannot use the information and data contained in the submissions for any other purposes than those related to the concerned procedure.

Overall, the PRAC will issue a recommendation for the assessment of the following PSURs:

- PSURs of centrally authorised product(s);
- PSURs of any mix of centrally authorised products and nationally authorised products (including through the mutual recognition and decentralised procedures);
- PSURs of nationally authorised products.

Please note that, for nationally authorised medicinal products which are marketed in only one Member State and whose active substance or combination of active substances is included in the EURD list, the MAH should submit a PSUR as part of PSUSA procedure. Note that a PSUSA is foreseen for each active substance or combination of active substances registered in the EURD list.

For purely nationally authorised medicinal products, containing substances or combination of actives substances not included in the EURD list, for which no PSUSA procedure has been established, the assessment of the PSURs will remain at national level.

Purely nationally authorised medicinal products are considered those which contain substances or a combination of actives substances which are only authorised in one Member State.

### ***17.3. How shall I present my PSUR and in which format? Rev. May 2020***

The format and content of the PSUR, is legally required according to Commission implementing Regulation (EU) No 520/2012 since January 2013 and is further described in the Guideline on good pharmacovigilance practices (GVP) Module VII – Periodic safety update report.

In addition, the required format and content of PSURs in the EU are based on those for the Periodic Benefit Risk Evaluation Report (PBRER) described in the ICH-E2C(R2) guideline (see Annex IV ICH-E2C(R2)). To keep the terminology consistent with the one used in the EU legislation, the new PBRER continues to be described as PSUR.

Unless otherwise requested by competent authorities, the marketing authorisation holder shall prepare a single PSUR for all its medicinal products containing the same active substance with information covering all the authorised indications, route of administration, dosage forms and dosing regimens, irrespective of whether authorised under different names and through separate procedures. Of note, the PSUR section "Worldwide marketing authorisation status" applies irrespective to centrally authorised products and nationally authorised products. Regarding centrally authorised products, the marketing status should also be provided as a stand-alone report through the relevant mailbox and

using the dedicated template as indicated in the EMA Post-authorisation Guidance on 'marketing and cessation notification' – *What is the reporting format to the agency and to whom to report.*

Even if a single PSUR is prepared for several products, please note that for medicinal products with documentation previously submitted in eCTD format, PSURs should be presented in a new eCTD sequence in the respective eCTD lifecycle of the concerned product. Where relevant, data relating to a particular indication, dosage form, and route of administration or dosing regimen, shall be presented in a separate section of the PSUR and any safety concerns shall be addressed accordingly.

Within the PSUR, the marketing authorisation holder is required to consider the impact of the data and evaluations presented within the report, on the marketing authorisation. Based on the evaluation of the cumulative safety data and the risk-benefit analysis, the marketing authorisation holder shall draw conclusions in the PSUR as to the need for changes to the product information of the products covered by the PSUR. For the purpose of analysing the impact of the PSUR data, the MAH can establish a so-called reference product information which should include "core safety" and "authorised indications" components, as explained in the GVP module VII on PSURs (section VII.B.4. 'Reference information'). The changes proposed to the labelling can be based on the reference product information. However, as the reference product information might be different for the various EU product information, it is essential that the MAH considers the proposed changes for the reference product information in the context of the different EU product information for the products covered by the submitted PSUR. This should be clearly discussed in both the conclusions and actions section of the body of the PSUR as well as in the EU regional appendix.

In the EU regional appendix, sub-section "Proposed product information" of the PSUR, the marketing authorisation holder should provide their proposal for product information (SmPC and package leaflet) changes based on the above-mentioned evaluation. These should take into account all EU authorised indications for products containing that active substance or combination of active substances. For marketing authorisation holders of nationally authorised products with a large number of marketing authorisations with different product information, the Agency will also accept that the core message of the proposed changes to the product information be included in the EU regional appendix as described below (see question "*How can I propose changes to the Product Information within the PSUR for NAPs which are part of an EU single assessment?*").

It is important that changes proposed to the product information which are based on the submitted PSUR data are not submitted in parallel via a separate variation procedure.

Additional clarification on the content of the PSUR can be found in the explanatory note to GVP Module VII and should be used by MAHs for the preparation of PSURs subject to single assessment. As it complements GVP Module VII, both documents should be consulted in conjunction. The explanatory note will form the basis of the upcoming revision of GVP VII; this update, once finalised, will therefore supersede this guidance document.

The explanatory note highlights and addresses challenges specific to the EU single assessment for nationally authorised products. Points highlighted in this document may nevertheless also apply to the assessment of centrally authorised products and hence it is recommended that all MAHs consult the document prior to finalisation of their PSUR.

In connection with the explanatory note to GVP Module VII, an assessors question and answer guidance document has also been developed.

The submission should include a cover letter and in order to facilitate the registration of the submission, marketing authorisation holders are required to fill in all the submission attributes through

the eSubmission delivery file UI. This delivery file should be completed in accordance with the published EURD list, where the procedure number is the combination of a unique ID and the applicable Data Lock Point (DLP) in YYYYMM format.

All the entries in the EURD list have been assigned a procedure number presented in the column "Procedure number of the PSUR single assessment".

In order to facilitate the identification of procedures containing centrally and/or nationally authorised substances, the extra columns "Centrally Authorised Product (CAP) and "Nationally authorised product (NAP)" have been added in the EURD list".

In line with article 57(2) of Regulation (EU) No 1235/2010 all holders of marketing authorisations for medicines in the European Union and the European Economic Area must submit information to the European Medicines Agency on authorised medicines and keep this information up to date. This is a legally binding requirement from the EU pharmaceutical legislation. The Agency uses this information to support the analysis of data, regulatory activities and communication. In relation to the submission of PSURs, this facilitates the processing of the submissions in the PSUR Repository.

Please see question "To whom should I submit my PSUR?" for further details on submission requirements.

#### **References**

- Directive 2001/83/EC
- Guideline on good pharmacovigilance practices (GVP) – Module VII –Periodic safety update report
- Commission implementing Regulation (EU) No 520/2012 on the performance of pharmacovigilance activities
- ICH guideline E2C (R2) Periodic benefit-risk evaluation report
- Explanatory Note to GVP Module VII
- Harmonised Guidance for eCTD Submissions in the EU

#### **17.4. What is the List of European Union reference dates (EURD list) and frequency of submission of PSURs? *Rev. Sep 2014***

The list of Union reference dates and frequency of submission of PSURs" (so-called the "EURD list") consists of active substances and combinations of active substances, for which PSURs shall be submitted in accordance with the EU reference dates and frequencies determined by the Committee for Medicinal Products for Human Use (CHMP) and the Coordination Group for Mutual Recognition and Decentralised Procedures - Human (CMDh) following consultation with the Pharmacovigilance and Risk Assessment Committee (PRAC).

The European Union reference date (EURD) corresponds to the date of the first or the earliest known date of the marketing authorisation in the EU of a medicinal product containing the active substance or combination of active substances.

In addition to the EU reference dates and frequencies of PSURs, the EURD list also provides the Data Lock Point (DLP) of the next PSUR submissions.



The EURD list facilitates the harmonisation of DLPs and frequency of submission of PSURs for medicinal products containing the same active substance or the same combination of active substances subject to different marketing authorisations, authorised in more than one Member State. This will, where appropriate, allow one single assessment of PSURs for products containing the same active substance.

The PSUR frequency as published on the EURD list for a given active substance or combination of active substances overrules the standard submission cycle (i.e. 6-monthly, yearly and thereafter 3-yearly) set out in the legislation and any condition related to the frequency of submission of PSURs included in the Marketing Authorisation. However, national competent authorities (NCAs) may still request the submission of a PSUR at any given time.

The EURD list is a living document, meaning that it can be amended whenever considered necessary by the PRAC, CHMP or CMDh in response to the emergence of relevant new safety information, newly authorised substances or requests from the marketing authorisation holders.

Full information on the EURD list is included in the GVP Module VII – Periodic safety update report and the introductory cover note to the EURD list.

For guidance on submission of requests for amendment of the EURD list, please refer to the question “*How can I request to amend the list of EU reference dates*”.

## References

- Directive 2001/83/EC
- Guideline on good pharmacovigilance practices – Module VII –Periodic safety update report
- List of European Union reference dates and frequency of submission of Periodic Safety Update Reports Introductory cover note

## **17.5. When do changes to the EURD list become legally binding? *Rev. Apr 2016***

The EURD list is updated on a monthly basis and any changes in the EURD list, such as the PSUR submission frequencies, the dates of submission and the PSUR submission requirement for medicinal products referred to in Articles 10(1), 10a, 14 or 16a of Directive 2001/83/EC come into force 6 months after its publication. This publication occurs after adoption of the EURD list by the CHMP and CMDh following consultation of the PRAC.

Whilst changes become binding 6 months after publication, there might exceptionally be situations where PSUR submissions are necessary prior to the new frequency taking effect and this will be indicated in the EURD list as well.

It is the responsibility of the marketing authorisation holder to check regularly the list of EU reference dates and frequency of submission published in the European medicines web-portal to ensure compliance with the PSUR reporting requirements for their medicinal products.

## Reference

- Directive 2001/83/EC

### **17.6. How can I request to amend the list of EU reference dates? Rev. Dec 2019**

Marketing authorisation holders can submit requests to the CHMP or the CMDh, as appropriate, to determine the Union reference dates or to change the frequency of submission of PSURs on one of the following grounds:

- for reasons relating to public health;
- in order to avoid a duplication of the assessment;
- in order to achieve international harmonisation.

The request and its grounds should be considered by the PRAC and the CHMP if it concerns at least one marketing authorisation granted in accordance with the centralised procedure or the CMDh otherwise, which will either approve or deny the request.

The list will then be amended accordingly when appropriate and published on the European medicines website.

For more details on how to submit amendments to the list, please refer to the EURD list cover note (section 4).

#### **Reference**

- Directive 2001/83/EC
- Guideline on good pharmacovigilance practices (GVP) Module VII – Periodic safety update report

### **17.7. Do I have to submit a PSUR if the active substance/combination of active substances of my medicinal product is not in the EURD list? Rev. Mar 2014**

If the active substance contained in the medicinal product is not included in the EURD list, the MAH should submit the PSUR directly to the PSUR repository, using the non-EU single assessment functionality, via the eSubmission Gateway. The PSUR will then be considered delivered to the relevant national competent authority (NCA) where the product is authorized. The frequency of submission shall be in accordance with the conditions specified in the marketing authorisation (MA), or otherwise according to the standard submission schedule of PSURs (i.e. 6-month intervals, yearly and thereafter 3 yearly). Marketing authorisation holders for certain medicinal products containing active substances not in the EURD list, such as medicinal products authorised under Article 10(1) or 10a of Directive 2001/83/EC, a homeopathic simplified registration or a traditional-use registration are not required to submit PSURs, unless there are specific requirements in the MA for the product. PSURs shall also be submitted upon request of NCA.

For more details on PSUR submissions for generics, products containing well-established substances, homeopathic or herbal medicinal products, please refer to the question *Do I have to submit a PSUR my medicinal product if it is a generic, a product containing a well-established substance, a homeopathic or herbal medicinal product?*

**17.8. Do I have to submit a PSUR if the combination of active substances of my product is not in the EURD list but one or more individual components are listed? *Rev. Mar 2013***

If the specific fixed dose combination is not listed in the EURD list, PSURs should not be submitted according to the EURD list entry of one or more individual components. However PSURs should be submitted as specified in the conditions of the marketing authorisation for the combination product (if any), or otherwise according to the standard submission cycle (i.e. 6-monthly, yearly and thereafter 3-yearly) unless the combination medicinal product falls within the categories of medicinal products exempted from the obligation to submit PSURs.

MAHs or national competent authorities can request the inclusion of the fixed combination in the EURD list for reasons related to public health, in order to avoid duplication of assessment or in order to achieve international harmonisation. Instructions on how to submit requests to amend the EURD list can be found on the EURD list webpage.

**17.9. Do I have to submit a PSUR if my medicinal product is not marketed? *Rev. Mar 2013***

MAHs are required to submit PSURs once a medicinal product is authorised in the EU, regardless of its marketing status.

**17.10. Do I have to submit a PSUR if the marketing authorization for my product has been granted on or after the data lock point (DLP) in the EURD list? *NEW Mar 2017***

The MAH is not obliged to submit a PSUR if the granting of the Marketing Authorisation (MA) was notified on or after the DLP. The first PSUR will either be due following the subsequent DLP in the EURD list or, depending on the newly approved MA, a first PSUR submission might be considered earlier than the next DLP. However, if the MA was granted before the DLP, the obligation to submit applies.

**17.11. My company holds a Parallel Import Authorisation; do we have to submit PSUR for these product(s)? If a PSUR is submitted will it be assessed? *NEW Mar 2017***

Only MAHs are required to submit PSURs as per the provisions of Article 107b of Directive 2001/83/EC and Article 28(2) of Regulation (EC) No 726/2004. Parallel importers do not qualify as MAHs, and therefore they are not subject to the obligation to submit PSURs.

If however a PSUR has been submitted by a company holding a parallel import authorisation, such PSUR might be taken into account by the Lead Member State/PRAC Rapporteur and assessed in terms of its impact on the risk-benefit balance of the medicinal product concerned. If the data contained in the PSUR contribute meaningfully to the scientific assessment, these data should be included in the scope of the PSUR procedure. However, the parallel importer will not become party to the PSUR

procedure and will not receive a copy of the assessment report and outcome documentation as a MAH would.

If a parallel importer receives a notification of an adverse drug reaction from a patient, a doctor or any other source, the parallel importer should inform this person that the adverse drug reactions should be reported directly to the MAH of the medicinal product concerned. The parallel importer should also inform the MAH immediately.

**17.12. Do I have to submit a PSUR for my medicinal product if it is a generic, a product containing a well-established substance, a homeopathic or herbal medicinal product? Rev. Mar 2017**

Medicinal products authorised under Articles 10(1), 10a, 14 or 16a of Directive 2001/83/EC are exempted from routine submission of PSURs unless otherwise specified in the marketing authorisation or required through the EURD list (see dedicated column "Are PSURs required for products referred to in Articles 10(1), 10a, 14, 16a of Directive 2001/83/EC as amended? Yes/No"). National competent authorities can also request PSUR for generic medicinal products at any time on the grounds detailed in Article 107c (2) of the Directive.

The MAHs of such medicinal products should use alternative mechanisms such as signal management and emerging safety issues channels to communicate relevant new safety information to regulatory authorities (see GVP Module VI and Module IX).

Additionally, product information should be kept up to date by the MAH by submitting the appropriate variations taking account of the latest scientific knowledge or conclusions of assessments and recommendations made public by means of the EMA and national competent authority websites.

Medicinal products which have been authorised through the equivalent legal basis as the current Articles 10(1) and 10a legal basis before the re-codification of the Directive 2001/83/EC i.e. respectively Article 4.8 a(iii), first paragraph (essential similarity) of Directive 65/65/EEC / 10 a(iii), first paragraph of Directive 2001/83/EC and Art 4.8 a(ii) (well established use) of Directive 65/65/EEC / 10.1 a(ii) of Directive 2001/83/EC are, by analogy, not required to submit PSUR unless there is a specific condition in the authorisation or there is an indication in the EURD list that PSUR submission is required, or in response to a specific request.

**17.13. Do I have to submit a PSUR for my hybrid medicinal product? Rev. Sep 2014**

Medicinal products authorised under Article 10(3) of Directive 2001/83/EC (hybrid application) are not exempted from the obligation to submit PSURs.

**17.14. Do I have to submit a PSUR if my medicinal product is authorised in accordance with Article 126(a) of Directive 2001/83/EC? *NEW Mar 2017***

Only MAHs are required to submit PSURs as per the provisions of Article 107b of Directive 2001/83/EC and Article 28(2) of Regulation (EC) No 726/2004. Holders of authorisation under Art 126a of Directive 2001/83/EC are not subject to the obligation to submit PSURs with regards to such authorisation.

**17.15. Will the withdrawal/non-renewal/revocation of the marketing authorisation of my product impact on the ongoing EU single PSUR assessment? *NEW Aug 2017***

In case of withdrawal, non-renewal or revocation of a marketing authorisation (MA) while the EU single PSUR assessment (PSUSA) procedure is ongoing, the impact on the ongoing procedure can be either that:

- the procedure will continue,
  - If the PSUSA procedure includes MAs remaining valid, or
  - If there are other medicinal products which contain the same active substance or combination of active substances (e.g. generics) as the medicinal product covered by the withdrawn/non-renewed/revoked MA,

OR

- the procedure will be stopped, if the withdrawn/non-renewed/revoked MA is the only MA covered by the ongoing PSUR assessment procedure, unless there are important safety concerns to consider the recall of any remaining medicinal products available on the market or the assessment could inform on public health concerns on long-term safety effects of the concerned product or evaluation of other medicinal products (e.g. same class of products) on the market regarding scientific and technical progress or future risk management or for other public health reasons.

For centrally authorised medicinal products, where the EU single PSUR AR will be completed, the information will be reflected in the EPAR of the concerned medicinal product.

**17.16. Will I have to submit PSUR after withdrawal/non-renewal/revocation/suspension of the marketing authorisation of my product? *Rev. Apr 2021***

Where a marketing authorisation is withdrawn, revoked or not renewed, the former marketing authorisation holder is encouraged to continue to collect spontaneous reports of suspected adverse reactions occurring in the EU (see GVP Module VI) to, for example, facilitate review of delayed onset adverse reactions or of retrospectively notified cases of adverse reactions.

Depending on the date of the EC decision on the revocation or withdrawal, or the date of expiry of the marketing authorization in case of non-renewal, marketing authorisation holders may still be required to submit a PSUR:

- If the date is after the submission deadline specified in the EURD list, submission is mandatory irrespective of whether the date is before or after the start of the procedure.

- If the date is prior to the submission date specified in the EURD list, submission is no longer required except for exceptional cases for centrally authorised medicinal products, whereby the former marketing authorisation holder may be requested to submit a final / ad-hoc periodic safety update report (PSUR). An agreement on the procedural details of the PSUR submission should be reached between the marketing authorisation holder and the Agency. Since such PSUR will not be subject to a single PSUR assessment, it should not be submitted to the PSUR repository.

In the case when the marketing authorisation of a medicinal product is suspended, this would not affect the requirement to submit a PSUR, since this situation corresponds to a temporary marketing cessation which could be lifted. The usual requirements in terms of submission apply. If the product has not been marketed during the whole reporting interval this should be specified in the PSUR.

### **17.17. Do PSURs need to contain case narratives and line listings? Rev. Sep 2014**

The PSUR should focus on summary information, scientific assessment and integrated benefit-risk evaluation.

Marketing authorisation holders are not required to systematically include listings of individual cases, including case narratives, in the PSUR. However, they shall provide case narratives in the relevant risk evaluation section of the PSUR where integral to the scientific analysis of a signal or safety concern in the relevant risk evaluation section.

In this context "case narrative" refers to clinical evaluations of individual cases rather than the CIOMS narratives included in the individual case safety report (ICSR).

During the assessment of the PSUR, line listings for adverse reactions of special interest may be requested by the PRAC.

#### **Reference**

- Guideline on good pharmacovigilance practices (GVP) Module VII – Periodic safety update report

### **17.18. How can I submit the proposed changes to the product information within the PSUR for the procedures which are part of an EU single assessment? Rev. Mar 2017**

According to the guidance set out in the GVP module VII on PSURs, proposed changes to the EU labels as a result of the PSUR data should be provided under Section VII.C.5.1. PSUR EU regional appendix, sub-section "Proposed product information" of the PSUR.

It should be presented as a tracked change version of each EU SmPCs and package leaflets of the products concerned and each product information should be translated into English language including the tracked changes proposed, in order to enable the EU single assessment.

This can result in having to submit a large number of sets of tracked change product information with the additional burden of providing translations. Hence MAHs can consider the option to focus on the proposed amendments to SmPC and package leaflet. In such case, only the amended parts of the

SmPC and package leaflet should be provided in track changes and in English language under the EU regional appendix.

Where the proposed changes are not based on the data submitted within the PSUR, these will not be considered, and a variation will have to be submitted as appropriate to the relevant national competent authority.

In case no changes to the product information are being proposed as part of the PSUR, the MAH should not include any product information within the EU regional appendix.

## Reference

- Guideline on good pharmacovigilance practices (GVP) – Module VII –Periodic safety update report

### **17.19. Can I submit a RMP update together with my PSUR? Rev. Dec 2018**

A risk management plan (RMP) update can be submitted with a PSUR for single centrally authorised medicinal product (CAP) or a mixture of CAPs belonging to the same global marketing authorisation (GMA) when the changes to the RMP are a direct result of data presented in the PSUR. In this case no stand-alone RMP variation is necessary.

If the above does not apply, the updated RMP should be submitted as a stand-alone variation.

A stand-alone variation should also be submitted for transitions to RMP Template Rev 2 when significant changes, not consequential to the PSUR data, are proposed in the RMP, i.e. safety specifications changes (reclassifications or removal of safety concerns) related to the implementation of GVP V “Risk Management Systems” Rev 2 principles. For the cases where there are also changes to the RMP consequential to the PSUR data, the stand-alone variation should be submitted in parallel to the PSUR procedure, to facilitate the assessment of the RMP update including both the changes related to the PSUR data and the other significant changes in the RMP to the safety specifications.

As an interim measure, submission of RMP updates cannot be accepted with PSURs subject to a PSUSA of:

- a mixture of CAPs pertaining to different GMAs;
- a mixture of centrally and nationally authorised medicinal products;
- a mixture of NAPs.

In these cases, MAHs should submit the updated RMPs as part of another procedure affecting the RMP, if one such procedure is foreseen. Alternatively, MAHs should submit a separate variation to update their RMP.

The EMA will check at the beginning of the procedure whether the submission of an RMP has been correctly performed in accordance to the above criteria. In order to facilitate this check, the MAH should confirm in the cover letter that the RMP update is a direct result of data in the PSUR. To further facilitate the check and assessment, the MAH should present clean and tracked changes Word versions of the RMP in the submission.

If an RMP is incorrectly submitted with a PSUR, this will be identified at the start of the procedure and both the MAH and PRAC Rapporteur will be made aware that the RMP will not be assessed and should be submitted through another appropriate procedure. If the RMP was submitted as an eCTD the MAH

will have to delete that version of the RMP in the next sequence to maintain the correct lifecycle of the product.

The assessment of a PSUR may result in a recommendation to update the content of the RMP through a subsequent variation.

For nationally authorised medicinal products (i.e. authorised through MRP, DCP or national procedures), any RMP update should be submitted via a variation procedure to the national competent authority for assessment, even if PSURs are part of a PSUSA.

### **17.20. Can I submit a clinical study report together with my PSUR? Rev. Aug 2020**

The PSUR should provide comprehensive information on the findings of all PASS, both interventional and non-interventional, in PSUR sections 7 and 8 respectively as an integrated summary.

Information regarding completed clinical trials provided in the PSUR section "Summaries of significant findings from clinical trials during the reporting interval" can be presented in the PSUR in either a narrative format or as a synopsis.

The PSUR is not the appropriate procedure for submitting final or interim study reports to the EU regulatory authorities. Final study reports should be submitted and assessed via the appropriate procedure in line with the guidelines on the details of the various categories of variations, on the operations of the procedures laid down in Chapters II, IIa, III and IV of Commission Regulation (EC) No 1234/2008. For centrally authorised products interim study reports not impacting on the product information or on the condition as stated in the Annex II of the marketing authorisation can be submitted as a post-authorisation measure (PAM) as described in question *How and to whom shall I submit my PAM data (see Post-authorisation measures: questions and answers)?*. For nationally authorised products, interim study reports, if requested, need to be submitted to the relevant competent authority unless specified otherwise.

However, in case a study report is able to further support either the discussion by the MAH or the PRAC/LMS' assessment of the PSUR sections dealing with data from clinical trials, findings from non-interventional studies, or other clinical trials and sources, the MAH may provide the study report (or relevant parts thereof) as an appendix to the PSUR. The inclusion as an appendix does not discharge the MAH from their obligation to submit procedure in line with the above-mentioned guidelines on the details of the various categories of variations.

Relevant interim and final study results should be included in the PSUR sections "Summaries of significant findings from clinical trials during the reporting interval" and "Findings from non-interventional studies", as applicable, in line with GVP VII.

### **17.21. What are the timelines for the submission of PSURs? Rev. Mar 2017**

Marketing authorisation holders should submit to the Agency PSURs as established in GVP Module VII as follows:

- within 70 calendar days of the data lock point (day 0) for PSURs covering intervals up to 12 months (including intervals of exactly 12 months); or



- within 90 calendar days of the data lock point (day 0) for PSURs covering intervals in excess of 12 months;
- the timeline for the submission of *ad hoc* PSURs requested by competent authorities will be normally specified in the request, otherwise the *ad hoc* PSURs should be submitted within 90 days of the data lock point.

The deadline for the submission of PSURs (Day 70 or Day 90 following the DLP) is published in the EURD list. This deadline is legally binding and must be adhered to. However, the PSUR repository allows for a submission window between the DLP and the submission deadline, there is therefore no technical restriction preventing MAHs to submit their PSUR in advance of the deadline.

The procedural start dates are published in the PSUR assessment timetable. It should be noted that the PSUSA cut-off date continues to apply to procedures containing nationally authorised medicinal products and indicates the next upcoming start date for relevant submission deadlines in the EURD list.

The timetables for the PSUR assessments are published on the EMA website.

#### References

- Guideline on good pharmacovigilance practices (GVP) Module VII – Periodic safety update report, Rev 1 (EMA/816292/2011, 09 December 2013)
- Timetable: Periodic Safety Updated Reports (PSUR)

### **17.22. What happens if I missed the submission deadline? *NEW Dec 2017***

It is the responsibility of MAHs to ensure that they submit the necessary PSUR by the submission deadline as stated in the EURD list and that they are not in breach of their legal obligations with respect to the submission of PSURs.

If you have missed the submission deadline due to technical issues with the PSUR Repository, please contact EMA as soon as possible via the Service Desk portal in order to request a late submission ID. Please note that late submissions can no longer be accepted once the procedure has started.

#### References

- User Guidance for Marketing Authorisation Holders (MAHs) for PSUR Repository

### **17.23. To whom should I submit my PSUR? *Rev. Mar 2017***

The use of the PSUR Repository is mandatory for all PSUR submissions. MAHs are required to submit PSURs directly to the PSUR repository using the eSubmission Gateway; the submission of PSURs directly to national competent authorities is no longer accepted. This affects all PSURs irrespective whether they are for centrally or nationally authorised medicinal products and whether they follow the EU single assessment or purely national PSUR procedure.

The obligation to submit to the PSUR Repository does not apply to products that have been given a positive CHMP scientific opinion under Article 58 of Regulation (EC) No 726/2004. For further information on how to submit PSURs for Article 58 products please refer to the guidance on Dossier requirements for Centrally Authorised Products (CAPs).

The use of the xml delivery file for submissions to the PSUR Repository is mandatory for all PSURs and any related submissions via the eSubmission Gateway and/or the Web Client. PSURs and any related submissions using the existing file naming conventions are no longer possible. The mandatory use of the PSUR xml delivery file is introduced to harmonise the submission mechanism for all PSURs and it applies to all types of PSURs and any related submissions. For further instructions on creation of the xml delivery file, please refer to the MAH PSUR Repository User Guidance document.

## References

- Dossier requirements for Centrally Authorised Products (CAPs)
- CMDh PSUR submission guidance document
- PSUR Repository MAH User Guidance document
- eSubmission website
- eSubmission Gateway / Web Client website
- Common Repository website
- PSUR Repository website
- Harmonised Guidance for eCTD Submissions in the EU

### **17.24. How to identify the official contact person for the PSUR? *NEW Mar 2017***

The official contact person for the PSUR procedure is the one provided in the xml delivery file. This person will be the sole recipient of any communication from EMA throughout this procedure, including the PRAC Recommendation, CHMP/CMDh output, and Commission Decision, as applicable. The contact information provided in the xml delivery file will always override any information provided in the cover letter.

### **17.25. What fee do I have to pay? *Rev. Apr 2021***

The EMA levies a fee for the assessment of PSUR(s) since 26 August 2014.

For the PSUR assessment involving only one marketing authorisation holder (MAH) the total amount of the fee will be levied on that MAH.

For the PSUR assessment under a PSUSA procedure involving more than one MAH, the total amount of the fee will be divided among all the MAHs concerned proportionately to the number of chargeable units.

The MAHs concerned will be established on the basis of the obligation to submit the PSUR(s) and not on the basis of the actual PSUR submission(s) received by the EMA.

The total of chargeable units in the procedure will be identified from the Art. 57 database. The share payable by each marketing authorisation will be calculated by the EMA. An advice note will be generated at the data lock point (DLP) date and sent accordingly to the relevant QPPVs in order to ensure the accurate identification of the chargeable units for the products involved in the procedure. At

start of the procedure, the invoice will be sent to each MAH with the relevant chargeable units calculation. The fee will be due to the EMA within 30 calendar days from the date of the invoice.

Applicants requiring a purchase order number or similar references on their invoice are encouraged to issue a standing (blanket) purchase order covering pharmacovigilance fees levied by the Agency for a given period and to provide such reference to the Agency's accounts receivable service at [accountsreceivable@ema.europa.eu](mailto:accountsreceivable@ema.europa.eu). The Agency does not accept stand-alone notifications of purchase order numbers or purchase order numbers associated with a dossier for this type of procedure only.

For MAHs already qualified as an SME (i.e. micro-, small- or medium-sized enterprise) by the EMA or for those that will send a SME declaration in advance of the start date or by the latest after 30 days of the invoice date, the fee will be reduced (small- or medium-sized enterprise) or waived (micro-sized enterprise).

The EMA has published further guidance on how the fees are calculated and collected.

### **References**

- Pharmacovigilance fees payable to the European Medicines Agency
- SME declaration
- Data submission for authorised medicines

### ***17.26. How will my PSUR submission be handled? Rev. Feb 2019***

The PSUR assessment under a PSUSA procedure is as follows, regardless whether it refers to one or more centrally authorised medicinal products, a mix of centrally authorised medicinal products and nationally authorised products, or nationally authorised products only.

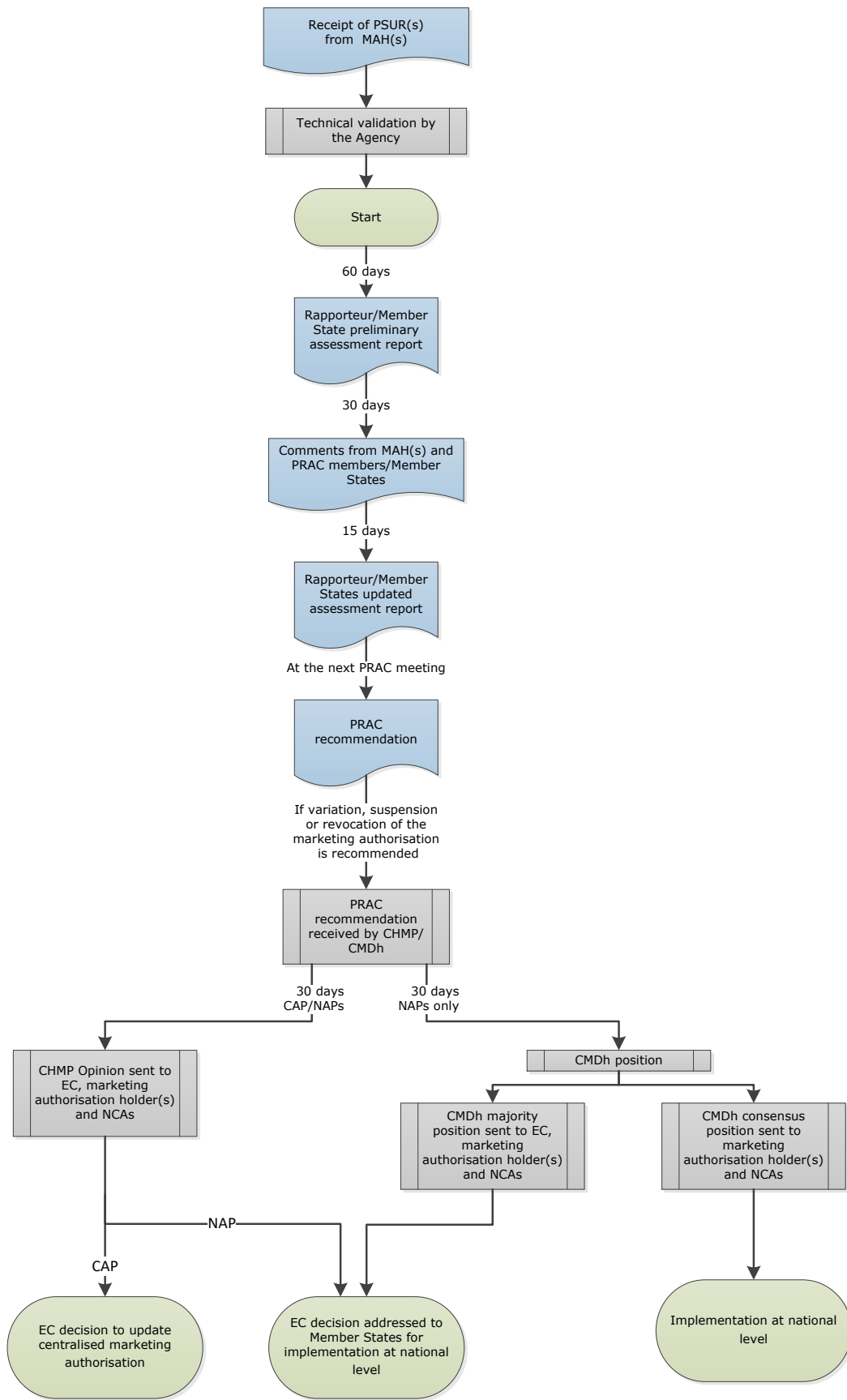

The assessment of a PSUR or several PSURs for the same active substance(s) is done by the PRAC or in case of nationally authorised products only by the appointed Lead Member State, respectively. The timelines for assessment are for up to 134 days followed by 67 days of Commission decision making process (if applicable). Upon technical\* validation by the EMA of the submitted PSUR(s), the following timetable shall apply:

Day	Action
Day 0	Start of the procedure according to the published timetable
Day 60	PRAC Rapporteur's / Lead Member State preliminary assessment report
Day 90	MAH and PRAC members' / Member States comments
Day 105	PRAC Rapporteur's / Lead Member State updated assessment report (if necessary)
Day 120	PRAC recommendation adoption with the PRAC assessment report
Day 134	CHMP opinion / CMDh position (in case PRAC recommends a variation, suspension or revocation of the MA)

\* There is no validation of the content of the PSUR.

The MAH is expected to provide, as applicable, by Day 90:

- responses to the "request for supplementary information" as outlined in the relevant section of the PRAC Rapporteur / Member State PSUR preliminary assessment report,
- comment on the proposed wording (in case the recommendation is a variation),
- propose a wording in case the recommendation is a variation but no exact wording is proposed by the PRAC Rapporteur / Lead Member State,
- provide a justification in case the MAH does not agree with the PRAC Rapporteur / Lead Member State recommendation to vary, suspend or revoke the MA; and/or
- include additional comments or clarification deemed necessary by the MAH

The MAH's comments should be submitted as per the PSUR dossier submission requirements detailed in the question "*How shall I submit the response to a request for supplementary information during a PSUSA procedure?*".

In case of major disagreement with the PRAC Rapporteur's/Lead Member State's proposed Recommendation as stated in the updated assessment report, the MAH should contact the Product Lead (for CAPs) or Risk Management Specialist (for NAPs only) no later than two working days following receipt of the report. In this communication the MAH should indicate whether they would wish to make use of the opportunity of an oral explanation to defend their position before the PRAC. In the absence of a reply within two days, the EMA will assume that no oral explanation is requested.

The MAH of centrally authorised medicinal products should submit a clean and a tracked version of the agreed amended product information prior to the adoption of the PRAC recommendation.

In case the PRAC adopts a recommendation on the maintenance of the marketing authorisation, such recommendation is not transmitted to the CHMP or CMDh and the procedure ends with the adoption of the PRAC recommendation.

In case the PRAC recommends any regulatory action i.e. variation, suspension or revocation of the marketing authorisation, the PRAC recommendation will be transmitted to the CHMP if it includes at least one CAP or to the CMDh if it includes only NAPs. At its next meeting following the PRAC recommendation, the CHMP or the CMDh, as applicable, will adopt an opinion or a position, respectively. Subsequently, where the procedure includes at least one CAP, the Commission will adopt a decision to the MAHs for the centrally authorised products and, as applicable, to the competent authorities of the Member States for nationally authorised products. Where the procedure includes only NAPs, the procedure ends with the CMDh position in case of consensus and in case of a majority vote, the CMDh position will be followed by a Commission decision (CD) to the Member States, which respectively have to be implemented according to the timetable indicated in the CMDh position or within 30 days of the CD receipt by the Member States. For further details on the procedural aspects of the EU PSUSA for NAPs only, please refer to the relevant CMDh SOP.

The outcome of the PSUR assessment results in a legally binding decision or CMDh position and any action to vary, suspend or revoke the marketing authorisations must be implemented in a harmonised and timely manner for all products within the scope of the procedure across the EU.

There may be times when MAHs are requested to take action on the basis of aspects which was not necessarily part of the PSUSA procedural scope e.g. product information of some generics not in line with that of the originator, or products which have not implemented the outcome of a previous regulatory procedure. In such cases this information will be included in the "Other considerations" section of the PRAC assessment report. Any information included in this section, will be discussed by the CMDh (for nationally authorised products) with the aim of agreeing on any necessary action, which will then be transmitted to MAHs either in the CMDh minutes or as a press release (dependent on the issue). Guidance on the content of the "Other considerations" section may be found in the published PRAC PSUR assessment report templates (Templates for assessors).

Amendments to the SmPC, labelling and package leaflet as a result of the PSUR assessment are implemented without subsequent variation submission for centrally authorised products and through the appropriate variation at national level for nationally authorised products (including those authorised through the mutual recognition and decentralised procedures).

## References

- Guideline on good pharmacovigilance practices (GVP) Module VII – Periodic safety update report
- CMDh SOP
- Guidance to applicants /marketing authorisation holders (MAHs) on oral explanations at EMA

**17.27. How shall I submit the response to a request for supplementary information during a PSUSA procedure? Rev. Oct 2019**

No specific template needs to be followed for the responses to the request for supplementary information (RSI).

The submission requirements for responses to requests for supplementary information are the same as those for the submission of the PSURs. For the submission of responses to the PSUR Repository, the xml delivery file is filled in the same way as the original PSUR submission apart from the selection of 'response' as a regulatory activity (submission unit). This xml delivery file should be attached to the relevant eCTD/NeeS sequence submitted via the eSubmission Gateway/Web Client. The regulatory activity 'PSUR' can only be used for the 'initial' PSUR submission due to the built-in business rules linking to the submission deadline.

Please refer to the e submission webpage and the PSUR Repository MAH user guide for more information on the creation of the delivery file.

**17.28. How is the CHMP opinion/CMDh position structured and which annexes need to be translated? Rev. Apr 2021**

This section presents the translation process of procedures of the below Annexes to the CHMP opinion / CMDh position. The Annexes of both the CHMP opinion as well as the CMDh position will be translated into all EU languages following an agreed timetable.

In addition, a linguistic review by Member States of these Annexes in all EU languages is performed after adoption of the CHMP opinion and CMDh position.

Please be reminded that in accordance with Union data protection requirements, no personal data should be included in the annotated product information annexes. This applies to the English version submitted at the time of opinion, the draft translations submitted at Day+5 and the final translations submitted at Day+25. Please submit annotated product information annexes in an anonymised format (i.e. names of the reviewers removed from the track-changes). If you do not wish to do so, please ensure that the individuals whose data is included consented to its sharing with EMA and its further sharing by EMA with third parties such as other marketing authorisation applicants, marketing authorisation holders and National Competent Authorities, as relevant. EMA expressly disclaims any liability or accountability for the presence of unnecessary personal data in the annotated product information annexes submitted by the marketing authorisation holder.

**Procedures that contain centrally authorised products (CAP(s))**

- Annex B: Annexes I, II, IIIA, IIIB, IV<sup>1</sup> (scientific conclusions and grounds for the variation of the marketing authorisation) and 127a (risk minimisation measures addressed to Member States)

**Procedures that contain a mix of centrally authorised products (CAP(s)) and nationally authorised products (NAP(s))**

For the CAP(s):

- Annex B: Annexes I, II, IIIA, IIIB, IV<sup>11</sup> (scientific conclusions and grounds for the variation of the marketing authorisation) and 127a (risk minimisation measures addressed to Member States)

For the NAP(s):

- Annex C:
  - Annex I (scientific conclusions and grounds for variation to the terms of the marketing authorisations)
  - Annex II (amendments to the product information of the nationally authorised medicinal products)
  - Annex III (conditions to the marketing authorisations), as applicable

**Procedures that contain nationally authorised products (NAP(s))**

- Annex C:
  - Annex I (scientific conclusions and grounds for variation to the terms of the marketing authorisations)
  - Annex II (amendments to the product information of the nationally authorised medicinal products)
  - Annex III (conditions to the marketing authorisations)
  - Annex III or IV (timetable for implementation<sup>12</sup>)

## **The preparation of the translation process**

In view of the short timeframe for finalisation of the translations and in order to optimise the quality of the translations, the MAHs are strongly advised to prepare for the translation process well in advance in the pre-opinion / position stage, i.e. just following adoption of the PRAC recommendation for variation.

In case of a PSUSA procedure where several MAHs are involved, the EMA will coordinate the translation process by approaching the MAHs individually and provide the timelines accordingly. MAHs should translate all relevant Annexes for each procedure.

## **During the translation process**

Depending on the type of outcome and whether a Commission Decision is required irrespective whether the procedure includes CAPs and/or NAPs, the timelines for the translation process vary depending on the need for a linguistic review as illustrated below:

---

<sup>11</sup> Annex IV are part of the next EPAR publication. However, they will not remain part of the EPAR and will become obsolete with the next following EPAR revision. They, however, remain part of the Commission Decision in the Union Registry on the Commission's webpage.

<sup>12</sup> This timetable is adopted in case a CMDh position reached by consensus and therefore not followed by a Commission Decision; in case of a majority position, the deadlines foreseen in the legislation for implementation after the Commission Decision apply



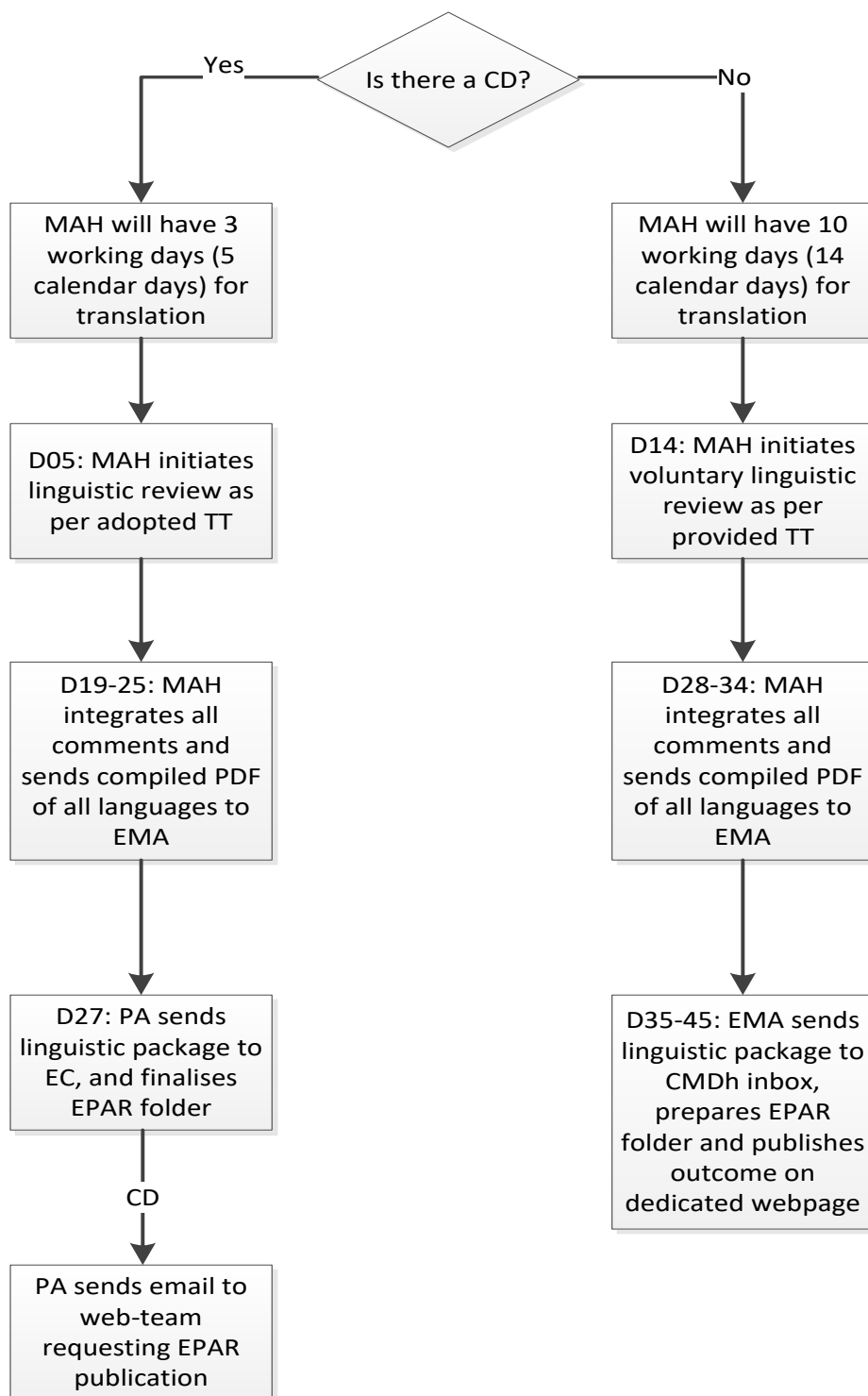

- a) In case of CHMP opinion or CMDh position by majority i.e. followed a Commission Decision, the MAH has to provide the translations of the adopted Annexes in all EU languages (including Icelandic and Norwegian – if applicable as detailed below) according to the following timelines:

Day 5 (5 days after opinion/ position)	Translations of the adopted Annexes in EN and in all other EU languages (including Icelandic and Norwegian) are to be provided electronically (in one Eudralink package if applicable) to the Member States (MS) Contact Points for Translations and to the EMA's procedure assistant and the PSUSA Mailbox.
Day 19 (19 days after opinion/ position)	Member States will send linguistic comments on the Annexes to the MAH by e-mail with a copy to the PSUSA Mailbox.
Day 25 (25 days after opinion / position)	<p>The MAH(s) will implement the required changes, compile the translations and send it back to the EMA.</p> <p>In case of disagreement between a Member State and the MAH, the EMA will not interfere in the translation process at this stage. Disagreements should be solved directly with the concerned MS.</p> <p>In order to facilitate and accelerate the check of the implementation of the' comments, the MAH should indicate in "QRD Form 2" for each language if all comments have been implemented or not. In the latter case, a justification should be provided for the appropriate language(s) stating why certain comments are not reflected in the final texts.</p>

- b) In case of CMDh position by consensus, Member States may perform a voluntary linguistic review in the translation process, therefore the following timelines apply:

Day 1 – 14 (1 to 14 days after position):	MAH translates the adopted Annexes in <b>all</b> other EU languages based on the EN provided version. MAHs with marketing authorisations in Iceland and/or Norway will provide these languages as well.
Day 15 (15 days after the position):	Translations of the adopted Annexes in EN and all other EU languages (incl. Icelandic and Norwegian if applicable) are to be provided electronically (in one Eudralink package if applicable) to the Member States (MS) contact Points for Translations and to the EMA's procedure assistant and the PSUSA Mailbox for voluntary linguistic check.
Day 28-34 (28-34 days after position)	<p>The MAH(s) will implement the required changes.</p> <p>Translation of the adopted Annexes in EN and in all other EU languages (Including Icelandic and Norwegian) are to be compiled and provided</p>

	electronically (in one Eudralink package if applicable) to the EMA's procedure assistant and the PSUSA Mailbox.
Day 35-45 (35-45 days after position)	The EMA will send the package to the CMDh and prepare the translations for publication.

## After the translation process

Once the translations are received from the MAH, the Agency will check if all Member States' comments have been implemented.

- a) In case of a CHMP opinion or a CMDh majority position the Agency will compile the Annexes in all languages and send the final copies to the Commission, members of the Standing Committee and the MAH(s) at Day 27 (27 days after opinion).  
Following receipt of the final compiled translations, the Commission will start the 22-day Standing Committee consultation, addressing only legal and public health matters (which means in principle no further linguistic review).
- b) In case of a CMDh position (by consensus), the Agency will compile the Annexes in all languages, send the final copies to the Member States and, where applicable, the full set of Annexes will be published on the EMA website.

## Standards of translation of Annexes

- The structure of the English Annexes has to be strictly followed and should be exactly translated as per the adopted English version (i.e. full product information or only amendments to the relevant sections of the product information).
- For translations of Annexes QRD templates for each language should be used
- Make sure that the title pages are adjusted and all brackets (i.e. <>) are taken out in the title.
- Do not leave sections out, do not update the Annex III, e.g. the sections [to be completed on a national level] simply to be translated as 'to be completed on a national level'.
- Good quality of the translations and compliance with the Member States' comments is required to facilitate the process.

If a translation is considered not to be of an acceptable quality, the Member State concerned will inform the MAH and the Agency within 3 days of receipt of the translation. The Agency will inform the MAH of the insufficient quality of the translations and the transmission to the Commission will be delayed until receipt of the amended translation (which would be expected within 1 week). A revised timetable will then be prepared.

The MAHs are also strongly advised to liaise directly with the Member States in case of disagreement with any of the comments made or in case further clarification on some comments is required, and to reflect the outcome in "QRD Form 2".

In addition, the MAHs are reminded that in case the complete product information is part of the Annex III, it should be presented in strict compliance with the QRD Convention (e.g. format, layout and margins).

The Agency will monitor the quality of the translations, the review by the Member States and industry's compliance with the Member States' comments as part of the Performance Indicators.

## References

- QRD Convention
- Product Information Templates
- Product Information: Reference documents and guidelines
- List of Member States contact points for translations (with guidance on the sending of product information to Member States)
- User guide on the preparation of PDF versions of the product information
- EC Guideline on the operation of the procedures laid down in Chapters II, III and IV of Commission Regulation (EC) No 1234/2008 of 24 November 2008

### **17.29. To whom should I submit follow-up data requested after the conclusion of a PSUSA procedure? *Rev. Feb 2019***

The submission of post-authorisation measures (PAMs) for CAPs to address follow-up data request to a PSUSA must be done in eCTD format via the eSubmission Gateway/Web Client and will be considered delivered to all national competent authorities' representatives, alternates and scientific experts. PAMs must not be submitted to the PSUR Repository.

As a general principle no follow-up measures for NAPs should be submitted to the Agency outside a formal procedure as there is no regulatory/legal framework to conduct the assessment. Should there be exceptionally follow up data for NAPs to be submitted further to a PSUSA procedure, these must not be submitted to the PSUR Repository. Submission and assessment is expected to take place at national level and, as necessary, be coordinated across the Member States. See also Question 'How will my PSUR be handled' about section 'Other considerations' of the PSUSA assessment report. MAHs should contact the relevant Risk Management Specialist in case of such requests if there is a need for initial clarification on the process.

### **17.30. How can I know about the outcome of a PSUSA procedure? *Rev. Dec 2019***

Information on the outcome of centrally authorised medicinal products is made available in the European Public Assessment Report (EPAR) page of the relevant medicine.

Information regarding the variation of NAPs that are part of a CAP/NAP procedure is available in the Community Register for nationally authorised products.

Information on the outcome of the EU single assessment of PSURs involving nationally authorised medicinal products only is made available on the EMA web page under 'Download medicine data section'.

**17.31. How shall I implement the outcome of a PSUSA procedure? *NEW*  
Mar 2017**

For PSUSA of CAPs the product information is varied as part of the Commission Decision issued to the MAHs, without the need for a variation. For CAPs outside the procedure (e.g. generics), the changes should be introduced through a variation IB C.I.3z.

For the NAPs included in the PSUSA procedure regardless whether NAP only, or mixed CAP and NAP products, the Commission decision is addressed to the Member States and therefore, it should be implemented by the NCAs within 30 days following its notification for all NAP products involved in the procedure (as listed in the Annex to the EC decision). By analogy to the implementation of referral procedures, the respective variations for the NAPs have to be submitted to the relevant NCA within 10 days after publication of the Commission Decision on the EC website.

For PSUSAs of NAPs, for which a CMDh position was adopted by consensus or majority (EC Commission Decision), a timetable for submission of the variations which is applicable for all affected products, including those that are not listed in the annex to the decision, is published on the EMA website. Changes to the product information after finalisation of a single PSUR assessment (with PRAC recommendation) may be implemented through the submission of a variation IA<sub>IN</sub> under category C.I.3.a if harmonised national translations are available and no further adaptation of the currently approved wording of the decision (EC Commission Decision or CMDh position) is necessary. In cases where the wording has to be adapted, a type IB under category C.I.3.z has to be submitted. In case the MAH wants to submit new data for assessment, a type II variation should be submitted.

For generic products or others not directly involved in the PSUSA procedure itself, the changes have to be submitted via a variation procedure according to the timelines indicated in the table below.

For NAPs, further guidance on implementing variation can be found on the CMDh website (Question & Answers, Pharmacovigilance legislation).

Product involved in procedure	CAP products		NAP products	
	Yes	No	Yes	No
Implementing variation needed, type and classification	Not applicable; implemented through commission decision to MAH	Yes IB C.1.3.z	Yes - IA <sub>IN</sub> C.1.3.a (harmonised national translations available) - IB C.1.3.z (adaptation of wording needed) - II (new data submitted; classification dependent on	Yes - IA <sub>IN</sub> C.1.3.a (harmonised national translations available) - IB C.1.3.z (adaptation of wording needed) - II (new data submitted; classification dependent on

			proposed changes)	proposed changes)
<b>Timeframe for submission of variation</b>	Not applicable	MAHs to submit variations within two months after receipt of the EMA communication encompassing the safety updates referred to in the relevant PSUSA procedure	For CMDh position <b>by consensus:</b> as per the date indicated in the translation timetable i.e. 105 <sup>13</sup> calendar days after adoption of the CMDh position.  For CMDh position <b>by majority vote:</b> 10 days after publication <sup>14</sup> of CD on EC website.  For CHMP Opinion: 10 days after publication of CD on EC website.	For CMDh position <b>by consensus:</b> as per the date indicated in the translation timetable i.e. 105 <sup>3</sup> calendar days after adoption of the CMDh position.  For CMDh position <b>by majority vote:</b> 60 days after publication of CD on EC website.  For CHMP Opinion: 60 days after publication of CD on EC website.

### **17.32. Can PSURs still be submitted with renewal application? Rev. Mar 2013**

PSURs, PSUR addendums, summary bridging reports and line listings should no longer be submitted as part of a renewal application. The clinical overview submitted in the renewal application should include relevant information to support the benefit-risk re-evaluation of the medicinal product. Please refer to the Guideline on the processing of renewals in the centralised procedure.

#### **References**

- Guideline on the processing of renewals in the centralised procedure
- Guideline on good pharmacovigilance practices (GVP) Module VII – Periodic safety update report

### **17.33. Who should I contact if I have a question regarding the preparation of a PSUR submission and during the procedure? Rev. Dec 2019**

For centrally authorised products (CAPs), if you cannot find the answer to your question in the Q&A when preparing your application or during the procedure, please contact the Product Lead responsible for your product.

<sup>13</sup> 45 calendar days for translation publication + 60 calendar days from publication of translations

<sup>14</sup> See also Q 3.3 of the Q/A-LIST FOR THE SUBMISSION OF VARIATIONS ACCORDING TO COMMISSION REGULATION (EC) 1234/2008

For nationally authorised products (NAPs), please submit your query using the ASK EMA feature.

In the web form you will be asked to provide your name, the name of your employer or organisation, contact details and the subject of your enquiry. You should type the full details of your query in the appropriate space. The use of key word 'PSUR' as a minimum in the subject line will help the Agency allocate your query to the correct person.

Please give as much detail as possible when completing your request (the procedure number of the PSUR single assessment as per the EURD list, the name of the product and the name of the active substance/combination of active substances) and be sure to include your correct and complete contact details. If the contact details you provide are incomplete or inaccurate this may prevent the Agency from communicating with you. In case of incomplete or incorrect data in the web form, the request may not be processed.

PSURs for NAPs will be handled by the Risk Management Specialist.

You will be able to contact the RMS throughout the procedure.

### ***17.34. Who should I contact if I have a technical issue with the submission of the PSUR? Rev. Mar 2017***

For PSUR repository interface, eSubmission Gateway and/or the Web Client questions, issues and requests for services, please contact us through the Service Desk portal. This portal improves the efficiency of the technical support by allowing users to report issues, track progress of their queries and obtain answers to frequently asked questions. This portal replaces the following mailboxes (gatewaysupport@ema.europa.eu eCTD@ema.europa.eu, and PSURrepository@ema.europa.eu) which are to be used for all technical queries concerning these IT systems, such as e.g. Web Client/Gateway set-up, registration details or the transmission failures of files in the production or test environment.

The Agency aims to respond to your query within 5 working days. To help us deal with your enquiry, please provide as much information as possible including whether your query refers to a NAP or a CAP, the procedure number of the PSUR single assessment as per the EURD list, the name of the product and the name of the active substance/combination of active substances in your correspondence.

Please refer to the e submission webpage and the PSUR Repository MAH user guide for additional information.

### ***17.35. Who should I contact if I have an issue related to the EURD list? Rev. Jun 2016***

For information on how to submit requests for amendments of the EURD list or any other questions related to the EURD list, please refer to the 'Introductory cover note to the List of European Union reference dates and frequency of submission of Periodic Safety Update Reports'.

#### **Reference**

- Introductory cover note to the List of European Union reference dates and frequency of submission of Periodic Safety Update Reports

### **17.36. Who should I contact if I have an issue related to the payment of fee and QPPV advice notes? *Rev. Apr 2021***

For queries on fees and QPPV advice notes (please refer to question “*What fee do I have to pay?*”), you can contact us using the designated EMA Fees Query Form available on the Pharmacovigilance fees page.

For queries on invoices already issued, please go to the Agency's How to pay page.

The Agency aims to respond to your query within 5 working days. To help us deal with your enquiry, please provide as much information as possible including whether your query refers to a NAP or a CAP, the procedure number of the PSUR single assessment as per the EURD list, the name of the product and the name of the active substance/combination of active substances in your correspondence.

#### **Reference**

- How to pay



## **18. Article 46 paediatric study submission**

### **18.1. What is the "Article 46 paediatric study submission"?**

Article 46 of Regulation (EC) No 1901/2006 (The 'Paediatric Regulation') sets out the obligation for the Marketing Authorisation Holder to submit to the competent authority any MAH-sponsored studies involving the use in the paediatric population of an authorised medicinal product, whether or not they are part of a PIP. For centrally authorised medicinal products, the studies should be submitted to the European Medicines Agency.

This includes clinical studies that are:

- completed or discontinued;
- published or not

Studies should be submitted regardless of the region where they were performed, the aim, outcome, population studied and indication.

#### **Reference**

- Article 46 of Regulation (EC) No 1901/2006

### **18.2. When shall I submit my article 46 paediatric study application? *Rev. Dec 2014***

The MAH should submit the paediatric study(ies) within 6 months of its completion and irrespective whether or not it is part of a PIP (completed/or not yet completed) or whether or not it is intended for submission later on as part of a variation, extension or new standalone Marketing Authorisation Application.

Completion of a study is defined in the Commission Guideline on the format and content of paediatric investigation plans. Clinical studies are deemed to have been completed on the date of the last visit of the last subject in the study or at a later point in time as defined in the protocol.

#### **Reference**

- ICH Topic E3, Note for Guidance on Structure and Content of Clinical Study Reports, CPMP/ICH/137/95
- Commission Communication, Guideline on the format and content of applications for agreement or modification of a paediatric investigation plan and requests for waivers or deferrals and concerning the operation of the compliance check and on criteria for assessing significant studies

### **18.3. How shall I present my article 46 paediatric study application at submission? *Rev. May 2020***

A paediatric study is to be submitted pursuant to article 46 as a post-authorisation measure ('stand-alone' submission). However, if amendments to be introduced to Product Information are identified by

the MAH, a variation (e.g. category C.1.4 or C.1.6) should be submitted directly containing the article 46 paediatric study.

The submission of an application under article 46 should include the following documents, preferably presented in accordance with appropriate headings and numbering of the EU-CTD format:

- Cover Letter including information on the context in which the article 46 paediatric study submission is made (e.g. stand-alone study or study included in a development program) and statement that there are no regulatory consequences identified by the MAH.
- In order to facilitate the registration of the submission, marketing authorisation holders are required to fill in all the submission attributes through the eSubmission delivery file UI.
- A completed PAM submission form with the full description of the PAM. The description should mention the due date (6 months from the completion of study). This form will ensure the correct classification of the submission, involvement of designated Committees(s) and timetable to be applied.
- A short critical expert overview clarifying the context of the data, including information on the pharmaceutical formulation used in the study, the existence of a suitable paediatric formulation and if relevant, conditions for an extemporaneous formulation
- Final clinical study report
- For a paediatric study that is part of a development program, a line listing (see template) of all the concerned studies

In case of submission of a variation including study relevant to article 46, the application should be presented in EU-CTD format accordingly to the guidance for variation (see also in guidance on variations). The following box should be ticked in the variation application form: "*THIS APPLICATION RELATES TO PAEDIATRIC STUDIES SUBMITTED ACCORDING TO ARTICLE 45 OR 46 OF THE PAEDIATRIC REGULATION*".

#### References

- ICH Topic E3, Note for Guidance on Structure and Content of Clinical Study Reports, CPMP/ICH/137/95

#### **18.4. How and to whom shall I present my article 46 paediatric study application? *Rev. Feb 2019***

Information is available on 'Submitting a post-authorisation application'.

#### **18.5. How shall the evaluation of my article 46 paediatric study application be handled (timetable), and what could be the outcome of the evaluation? *NEW Feb 2014***

The following **60-day timetable** shall apply to the **assessment of the paediatric study** submitted by the MAH:

Day	Action
Day 1	Start of the procedure as per published timetable (see below)
Day 30	Receipt of Rapporteur's Assessment Report
Day 45	CHMP Members' comments
Day 50	Receipt of Rapporteur's updated Assessment Report (if necessary)
Day 60 (CHMP meeting) (up to Day 90 if a Request for Clarification is needed)	CHMP adoption of conclusion or Request for Clarifications

The submission deadlines and full procedural detailed timetables are published as a generic calendar on the EMA website (see: submission deadlines and full procedural timetables).

The published timetables identify the submission, start and finish dates of the procedures as well as other interim dates/milestones that occur during the procedure.

The EMA will inform the MAH of the outcome of CHMP evaluation. The following may be envisaged depending on CHMP's conclusion at D60:

- No amendment to the product information is required at this point of time.
- Further clarifications are required. The CHMP will request additional clarifications (directly linked to the paediatric study submitted) and a 30 days extension of the timeframe will normally apply.
- A variation is needed to amend the product information in accordance with the CHMP conclusion. The variation submission is normally requested within 60 days after adoption of the CHMP conclusion. If the MAH is unable to submit the variation within this timeframe, he must justify the delay and inform the EMA/Rapporteur and propose a new submission date.

At the time of finalising an opinion, it may be needed that the MAH generate additional data (see also guidance on post-authorisation measures).

### **18.6. Do I have to pay fees for the article 46 paediatric study submission?** **NEW Feb 2014**

There is no fee payable for article 46 paediatric studies. However, the normal fees are applied to any variations containing Article 46 paediatric data or variations resulting from the assessment of such article 46 paediatric study submission.

### **18.7. Will there be any publication on the outcome of my article 46 paediatric study? Rev. Feb 2014**

The assessment report of the procedure will be published on the European Medicines Agency website under the EPAR tab of the product after removal of commercially confidential information.

#### **References**

- EPARs

## 19. Transfer of Marketing Authorisation

### 19.1. What is a Transfer of Marketing Authorisation? *Rev. Jul 2021*

A Transfer of Marketing Authorisation (MA) is the procedure by which the MA is transferred from the currently approved Marketing Authorisation Holder (MAH) to a new MAH which is a different person/legal entity.

Such a Transfer may result from the MAH's commercial decision to divest the MA or be needed in anticipation of the MAH ceasing to exist as a legal entity and MA being taken over by another legal entity.

In case a MA Transfer is sought for several medicinal products, an application must be submitted for each MA (i.e. 1 application per product).

A change of name and/or address of the MAH is not a MA Transfer if the holder remains the same person/legal entity. Such change should be notified through a Type IA<sub>IN</sub>, A.1 variation application.

A Transfer of MA does not include a Transfer of Orphan designation since this is subject to a different procedure (see also "Do I also have to transfer the Orphan designation when my medicinal product has been granted such a designation?").

A Transfer of a MA can only be initiated once a MA has been granted. In case there is a need to change the proposed MAH during the initial Marketing Authorisation Application procedure, the applicant who initially applied for the MA is advised to contact the Agency (see also 'Who should I contact if I have a question when preparing my application or during the procedure?').

From this point onward:

- The MAH of the MA to be transferred is termed the Transferor.
- The person/legal entity to whom the Transfer is to be granted is termed the Transferee.

#### References

- Commission Regulation (EC) No 2141/96 of 7 November 1996 concerning the examination of an application for the Transfer of a marketing authorisation for a medicinal product falling within the scope of Council Regulation (EC) No 2309/93
- Commission Regulation (EC) No 1234/2008 of 24 November 2008 concerning the examination of variations to the terms of marketing authorisations for medicinal products for human use and veterinary medicinal products

### 19.2. How shall I present my application for the Transfer of Marketing Authorisation? *Rev. Apr 2021*

Transfer applications should be presented as follows, in accordance with the appropriate headings and numbering of the EU-CTD format.

#### Module 1:

##### 1.0 Cover letter (signed by the Transferor) with the following documents attached:

All documents to be submitted from the Transferee and/or the Transferor, as appropriate, must be legible and preferably shall be printed on a headed paper. A template for each document is attached to provide guidance on the information that should be included in each document.

- 1) The name of the medicinal product concerned the authorisation number(s) and the date on which the authorisation was granted. (Attachment 1) – see “Authorisation details” of the product-specific webpage on the EMA website.
- 2) The identification (name, address, contact person at MAH address, telephone number and email address) of the Transferor and the Transferee\*. (Attachment 2)
- 3) A document certifying that the complete and up-to-date file concerning the medicinal product or a copy of this file including any data/documents related to the paediatric obligations has been made available to or has been transferred to the Transferee. (Attachment 3)
- 4) A document stating the date on which the Transferor and the Transferee finalise the transitional organisational arrangements and the Transferee takes over all responsibilities. This is referred to as the implementation date. The transitional period between the notification of the Commission decision on the transfer of a marketing authorisation and the implementation date should be proportionate to the organisational activities that need to be performed by the Transferor and Transferee and this date should not exceed 6 months (see also Transfer of Marketing Authorisation - “How to choose the implementation date?”) (Attachment 4).

If applicable, this document should include a “Statement of activities performed by the Transferor during the transitional period”. This statement should briefly provide the Agency with an overview of the organisational activities which will be performed by the Transferor - as agreed with the Transferee - during the transitional period. The transitional period is the period between the date of notification of the Commission Decision on the Transfer and the implementation date.

- 5) Proof of establishment of the Transferee within the EEA issued in accordance with national provisions. This document should be no older than 6 months. The Proof of Establishment is commonly issued by appropriate Chamber of Commerce. (Attachment 5)
- 6) Documents showing the capacity of Transferee to perform all the responsibilities required of a MAH under Union Pharmaceutical legislation:
  - 6.1) In case a summary of the pharmacovigilance system was introduced as part of the MA prior to the transfer, please submit an updated summary of the PSMF in Module 1.8.1 of the application and include the following elements:
    - proof that the applicant has at his disposal a qualified person responsible for pharmacovigilance,
    - the Member States in which the qualified person resides and carries out his/her tasks, the contact details of the qualified person,
    - a statement signed by the applicant to the effect that the applicant has the necessary means to fulfil the tasks and responsibilities listed in Title IX of Directive 2001/83/EC,
    - a reference to the location where the pharmacovigilance system master file (PSMF) for the medicinal product is kept

In case where no summary of the pharmacovigilance system was introduced as part of the MA prior to the transfer, a document should be provided identifying the qualified person

responsible for Pharmacovigilance (QPPV), the Member State(s) in which he/she resides and carries out his/her tasks, email address, telephone and fax numbers. It must be stated that the Transferee has permanently and continuously at its disposal the services of a QPPV, that it has the necessary means to fulfil the tasks and responsibilities listed in Title IX of Directive 2001/83/EC and that the QPPV resides and operates within the European Economic Area (Attachment 6.1). The statement should be signed both by the Transferee and the QPPV.

A switch from a Detailed Description of the Pharmacovigilance System (DDPS) to a Summary of the Pharmacovigilance System or the first introduction of a Summary of the Pharmacovigilance System cannot be included as part of the transfer application.

- 6.2) A document identifying the scientific service in charge of information about the medicinal product within the meaning of Article 98 of Directive 2001/83/EC, including the address, email address, telephone and fax number. (Attachment 6.2)
  - 6.3) A document identifying the person/company authorised for communication between the Transferee and the Agency after authorisation on the Transfer of MA\*. (Attachment 6.3)
  - 6.4) A document identifying the contact details of the person responsible for quality defects and batch recall within the meaning of Article 79 of Directive 2001/83/EC, including the Name, address, telephone, fax and email address. (Attachment 6.4)
- 7) If the medicinal product concerned has not yet been marketed in the EEA in any of its presentations, this should be specified in a signed statement. (Attachment 7)
- 8) If appropriate, a letter of recommendation or a letter of undertaking signed by the Transferee listing any remaining recommendations or follow-up measures. (Attachment 8)
- 9) A signed statement that no other changes have been made to the product information other than those to the details of the MAH and, if appropriate, the details of the local representatives. (Attachment 9)
- 10) Confirmation from the Name Review Group (NRG) on the acceptability of the proposed name, if applicable. When the name of a product is composed of INN + company name see (See also Transfer of Marketing Authorisation - "Can I change the name of a medicinal product as part of a transfer application?").

Documents 1, 2, 3, 4, and 9 must be signed by both the Transferor and the Transferee.

Document 7 must be signed by the Transferor.

Documents 6 and 8 must be signed by the Transferee.

\* Please be informed that in order to obtain access to EMA systems, it is now mandatory for contacts points to register at <https://register.ema.europa.eu> so as to have an active EMA account (see also 'Who should I contact if I have a question when preparing my application or during the procedure?').

### **1.3 Product Information**

#### **1.3.1 SmPC, Annex II, Labelling and Package Leaflet:**

The revised product information (SmPC, Annex II, labelling, and package leaflet) in all EU languages including Iceland and Norway must be provided electronically in Word format (highlighted using track changes) and in PDF format (clean).

Please be reminded that in accordance with Union data protection requirements, no personal data should be included in the annotated product information annexes. This applies to the English version and all the translations. Please submit annotated product information annexes in an anonymised format (i.e. names of the reviewers removed from the track-changes). If you do not wish to do so, please ensure that the individuals whose data is included consented to its sharing with EMA and its further sharing by EMA with third parties such as other applicants, marketing authorisation holders (MAH) and National Competent Authorities, as relevant. EMA expressly disclaims any liability or accountability for the presence of unnecessary personal data in the annotated PI submitted by the MAH.

### **1.3.2 Mock-up**

English and multi-lingual ('worst-case') colour mock-up of outer and immediate packaging for each pharmaceutical form in each container type (e.g. blister and bottle, vial and pen) in the smallest pack-size (see also "Transfer of Marketing Authorisation – Do I have to submit mock-ups and specimens?").

### **Reference**

- Commission Regulation (EC) No 2141/96 of 7 November 1996 concerning the examination of an application for the Transfer of a marketing authorisation for a medicinal product falling within the scope of Council Regulation (EC) No 2309/93
- The Revised Checking Process of Mock-Ups and Specimens of outer/immediate labelling and package leaflets of human medicinal products in the Centralised Procedure (EMEA/305821/2006)
- Guideline on Pharmacovigilance for Medicinal Products for Human Use, Volume 9A of the Rules governing Medicinal Products in the European Union

## **19.3. How and to whom shall I submit my Transfer of Marketing Authorisation application? *Rev. Feb 2019***

Information is available on 'Submitting a post-authorisation application'.

## **19.4. How shall my Transfer of Marketing Authorisation application be handled (timetable)? *Rev. Jul 2021***

A Transfer application follows a 30-day procedure following receipt of the application. There are no set submission dates. In order to choose the best submission date, especially in case of any other ongoing/expected procedures, the transferor should contact the EMA at least 1 month prior to the submission of the application (see also 'Transfer of Marketing Authorisation – Who should I contact if I have a question when preparing my application or during the procedure?').

Within 7 days upon receipt of the Transfer application, the EMA will check whether the Transfer application is correct and complete. In case the application is correct and complete the Agency aims to finalise the procedure by Day 10. In case of an incorrect or incomplete application the applicant will be notified and required to provide the amended and/or additional documentation via eCTD submission within 10 calendar days from the date of the EMA notification. The EMA will not be able to issue a favourable opinion on the Transfer in case the documentation is incomplete. Upon receipt of the applicant responses the Agency aims to finalise the procedure by Day 20.

In any case finalisation of the opinion should be within 30 days upon receipt of the Transfer application.

The Transfer opinion will be sent to the Transferor, Transferee, European Commission and the competent authorities of Iceland and Norway. Subsequently, the European Commission will issue a decision on the Transfer of the MA. The transfer of the marketing authorisation is authorised from the date of the notification of the Commission decision on the Transfer.

However, the Agency by mutual agreement with the Transferor and the Transferee can set an implementation date for the Transfer (see also "How to choose the implementation date?").

#### **Reference**

- Commission Regulation (EC) No 2141/96 of 7 November 1996 concerning the examination of an application for the Transfer of a marketing authorisation for a medicinal product falling within the scope of Council Regulation (EC) No 2309/93

### **19.5. How to choose the implementation date? Rev. Jul 2021**

The implementation date is the date on which the Transferee takes over ALL responsibilities as the Holder of the MA. This date is proposed by the Transferor and Transferee in the Transfer application will and be subject to agreement by the EMA. This date is stated on the opinion adopted by the Agency and also on the European Commission decision.

**For the Transfer of a Marketing Authorisation covering medicinal products already marketed by the Transferor**, the proposed date should be set taking into account the following timelines (see also "Transfer of Marketing Authorisation - How shall my Transfer of Marketing Authorisation application be handled (timetable)?"):

- The EMA timeframe for finalisation of the opinion is 30 days from the receipt of an application (Day A).
- The Commission will subsequently issue a Commission Decision on the Transfer of the marketing authorisation. As of the date of notification of the Commission Decision on the Transfer of the marketing authorisation (Day B), the Transfer is effective, and the Transferee becomes the new MAH of the medicinal product.
- Between Day B and Day C (implementation day) there is a transitional period during which the previous MAH and the new MAH have to finalise their organisational arrangements, as defined in the Transfer application (e.g. contractual agreements as regards to batch release). The Transfer application should include information as to the date on which the Transferor will release the last produced batch in the distribution chain, duly justifying why that particular date has been chosen. The transitional period between the notification of the Commission decision on the transfer of a marketing authorisation (Day B) and the implementation date (Day C) should be proportionate to the organisational activities that need to be performed by the Transferor and Transferee. Nevertheless, it should be noted that as of Day B, the Transferee becomes the new MAH of the medicinal product and the EMA will only deal with the new MAH for any further regulatory activity (e.g. variations applications).
- Before Day B the Transferor is responsible for released batches. As of Day B, the new MAH can start releasing batches. The batches released by the new MAH should be in accordance with the



Annexes of the Commission Decision on the Transfer and therefore, these batches should have the name of the new MAH in the Product Information. During this transitional period and on the basis of the arrangements agreed between Transferor and Transferee, batches bearing the name of the previous MAH can be placed on the market as well. Nevertheless, it should be noted that as of Day B, the responsibility on all released batches rely on the new MAH.

- After day C only the new MAH (Transferee) can release batches and place them on the market. The batches that have been placed on the market before Day C and that bear the name of the previous MAH can remain on the market.

**For the Transfer of a Marketing Authorisation covering medicinal products not yet marketed in the EEA by the Transferor**, the proposed date should always refer to the day on which the Commission Decision on the Transfer will be issued.

### ***19.6. What fee do I have to pay for my Transfer of Marketing Authorisation application? Rev. Apr 2021***

For information on the fee applicable for Transfer applications, please refer to the explanatory note on fees payable to the European Medicines Agency. Such fee covers all authorised presentations of a given medicinal product.

The fee will become due on the date of receipt of Transfer application notification and fees will be payable within 45 calendar days of the date of the said notification. After approximately 15 days an invoice will be sent to the applicants billing address held on the Agency's file.

The invoice will contain details of the product and type of procedure involved, the fee amount, financial information and the customer purchase order number associated with the procedures invoiced (if provided in the eSubmission delivery file). The Agency does not accept stand-alone notifications of purchase order numbers that are not associated with a dossier.

The Agency will charge the fee for Transfer application notification at the start of the procedure, irrespective of its outcome (positive, negative or partial/full withdrawal).

Guidance is available on how to pay an invoice.

#### **References**

- Fees payable to the European Medicines Agency

### ***19.7. How to handle planned/ongoing variations procedures during the Transfer of Marketing Authorisation? Rev. Jul 2021***

MAHs should avoid submitting variation procedures in parallel to a Transfer of MA application.

MAHs are strongly advised to contact the [EMA](#) in advance of the submission of the Transfer of application, in order to discuss how to handle any planned/ongoing procedures (especially in case the product information is affected) or in case there are variations linked to the Transfer procedure (see also "Transfer of Marketing Authorisation – Who should I contact if I have a question when preparing my application or during the procedure?").

## **19.8. How to handle remaining Post-authorisation measures and recommendations when transferring a Marketing Authorisation? *Rev. Dec 2013***

Enforceable post-authorisation measures (PAMs) may have been agreed for the medicinal product at the time of the granting of the marketing authorisation or subsequent modifications. If such PAMs are still remaining for the medicinal product concerned, it is the responsibility of the Transferee to fulfil them within the timeframe previously agreed.

In case of remaining recommendations or follow-up measures, a letter of recommendation or a letter of undertaking signed by the Transferee listing them must be submitted (Attachment 8 to the cover letter).

### **Reference**

- Commission Regulation (EC) No 2141/96 of 7 November 1996 concerning the examination of an application for the Transfer of a marketing authorisation for a medicinal product falling within the scope of Council Regulation (EC) No 2309/93

## **19.9. Do I have to submit mock-ups and specimens? *Rev. Dec 2015***

### **Mock-ups**

According to point 6 in the Annex to Regulation (EC) No 2141/96 on transfers of centrally authorised medicinal products, mock-ups are to be included in the transfer application. Ideally, applicants must provide at submission an English and multi-lingual ('worst-case') colour mock-up of outer and immediate packaging for each pharmaceutical form in each container type (e.g. blister and bottle, vial and pen) in the smallest pack-size. If not available, relevant example mock-ups of the marketed presentation may be submitted instead.

If the transfer only affects the MAH details on the packaging and package leaflet without any impact on the overall design, in addition to the submission of the mock-ups, a declaration stating that only the details of the MAH have been modified and that such changes will be introduced in all product presentations should be included in module 1.3.2 of the application dossier.

In case of comments on the mock-ups, the MAH should submit responses and/or updated mock-ups, as applicable, to the EMA ([muspecimens@ema.europa.eu](mailto:muspecimens@ema.europa.eu)) prior to the specimen printing. EMA will discuss the best and feasible corrective action with the MAH, taking into account the nature and amount of issues identified. EMA will endeavour to provide such feedback as soon as possible and taking into consideration the production plan of the medicinal product, as applicable.

### **Specimens**

Only in case the transfer has an impact on the overall design, relevant revised example specimens should be provided to the EMA by the new MAH, in line with the requirements for new applications and extensions.

If the transfer only affects the MAH details on the packaging and package leaflet without any impact on overall design, specimens are not required.

The EMA will perform a general check within 15 working days and will check if any previous comments on specimens have been duly implemented. The applicant will be informed about the outcome of the check.

In case of comments on the specimens, the MAH should submit responses and/or updated mock-ups, as applicable, to the EMA (muspecimens@ema.europa.eu) prior to the launch of the medicinal product. EMA will discuss the best and feasible corrective action with the MAH, taking into account the nature and amount of issues identified. EMA will endeavour to provide such feedback as soon as possible and taking into consideration the launch plan of the medicinal product, as applicable.

The above principles also apply to mock-ups for Iceland. The mock-ups should be sent by e-mail to mockups@ima.is. See also <http://www.ima.is/>.

No mock-ups and specimens are required for Norway.

### References

- The Checking Process of Mock-Ups and Specimens of outer/immediate labelling and package leaflets of human medicinal products in the Centralised Procedure (EMA/305821/2006/Rev.1)

### ***19.10. Do I also have to transfer the Orphan designation when my medicinal product has been granted such a designation? Rev. Dec 2007***

When transferring the MA of a designated Orphan medicinal product, the MAH must also transfer the Orphan designation of the product concerned in accordance with Article 5(11) of Regulation (EC) No 141/2000 in order to maintain the orphan status.

Transfers of orphan designation and transfers of MA are different procedures and must be handled as such. The applications for transfer of the orphan designation and transfer of the MA should preferably be submitted to the Agency at the same time. The cover letter accompanying each of the applications should make reference to the two applications, as the two procedures will be handled in parallel by the Agency.

Fee waivers can only apply to the transferred medicinal product once the transfer of the orphan designation is completed.

In preparing an application to transfer an orphan designation, sponsors should follow the guidance given in the European Commission's "Guideline on the format and content of applications for designation as orphan medicinal products and on the transfer of designation from one sponsor to another" and in the "Checklist for sponsors applying for the transfer of orphan medicinal product designation".

### References

- Article 5(11) of Regulation (EC) No 141/2000 of 16 December 1999 on orphan medicinal products
- Guideline on the format and content of applications for designation as orphan medicinal products and on the Transfer of designation from one sponsor to another, (ENTR/6283/00)
- Checklist for sponsors applying for the transfer of orphan medicinal product (OMP) designation" (EMA/41277/2007)

**19.11. Can I include changes to manufacturing sites in my Transfer of Marketing Authorisation application? Rev. Jul 2021**

Changes to a manufacturer(s) resulting from the transfer of the MA are not considered part of the transfer procedure. Therefore, the appropriate variations should be submitted separately. These variations will be handled separately from the transfer procedure. In such case, the MAH is advised to contact the [EMA](#) prior to submitting a transfer application in order to discuss the appropriate timeframe of such variations.

In addition, when the need for good-manufacturing practice inspections is anticipated by the MAH, it is advisable to contact the Agency in advance of the variation and transfer submission (see also “Transfer of Marketing Authorisation – Who should I contact if I have a question when preparing my application or during the procedure?”).

**19.12. Can I change the Qualified Person for Pharmacovigilance and what information on the summary of the transferee’s pharmacovigilance system should I submit as part of my Transfer of Marketing Authorisation application? Rev. May 2018**

A change to element(s) to the summary of the pharmacovigilance system master file (PSMF), e.g. the Qualified Person for Pharmacovigilance (QPPV) or of the PSMF location resulting from the transfer of the marketing authorisation (MA) can be notified as part of the transfer application without the need for a separate variation (see also “How shall I present my application for the transfer of marketing authorisation”).

The summary of the transferor’s pharmacovigilance system in the MA dossier needs to be replaced in the transfer application with an updated summary of the transferee’s pharmacovigilance system including:

- a proof that the transferee has at his disposal a QPPV, the Member State(s) in which the QPPV resides and carries out his/her tasks and its contact details,
- a statement signed by the transferee to the effect that the applicant has the necessary means to fulfil the tasks and responsibilities listed in Title IX of Directive 2001/83/EC,
- a reference to the location where the PSMF for the medicinal product is kept.

It is nevertheless required to update accordingly the information in the Article 57 database after the conclusion of the procedure for the MA transfer.

**References**

- Good pharmacovigilance practices
- Guidelines on Good Pharmacovigilance Practices (GVP) : Module I – Pharmacovigilance systems and their quality systems
- Guideline on Good Pharmacovigilance Practices (GVP): Module II – Pharmacovigilance system master file

- Commission Regulation (EC) No 1234/2008 of 24 November 2008 concerning the examination of variations to the terms of marketing authorisations for medicinal products for human use and veterinary medicinal products
- Commission Regulation (EC) No 1234/2008 ('the Variations Regulation') and the Guidelines on the details of the various categories of variations, on the operation of the procedures laid down in Chapters II, IIa, III and IV of Commission Regulation (EC) No 1234/2008 of 24 November 2008 concerning the examination of variations to the terms of marketing authorisations for medicinal products for human use and veterinary medicinal products and on the documentation to be submitted pursuant to those procedures

### **19.13. Can I change the name of a medicinal product as part of a transfer application? *Rev. Jul 2021***

In order to change the name of a medicinal product, a variation is required and should be submitted separately and in parallel to the transfer procedure.

In the case the transfer procedure concerns a medicinal product whose name is constructed as [INN / common name + name of the MAH], the name of the medicinal product needs to be changed to reflect the name of the new MAH (transferee) through a Type IA<sub>IN</sub> variation (No. A.2).

See also "Changing the (invented) name of a centrally authorised medicine: questions and answers" and the Generic and hybrid applications "How will I know if the proposed (invented) name of my generic/hybrid medicinal product is acceptable from a public health point of view?"

The acceptance by the Name Review Group (NRG) of the new name has to be finalised prior to the submission of the variation for changing the name of the medicinal product, including where the transferee wishes to use the common or scientific name, together with a trademark or the name of the MAH.

#### **Reference**

- Commission Regulation (EC) No 1234/2008 ('the Variations Regulation') and the Guidelines on the details of the various categories of variations, on the operation of the procedures laid down in Chapters II, IIa, III and IV of Commission Regulation (EC) No 1234/2008 of 24 November 2008 concerning the examination of variations to the terms of marketing authorisations for medicinal products for human use and veterinary medicinal products and on the documentation to be submitted pursuant to those procedures

### **19.14. Will there be any publication on the Transfer of Marketing Authorisation?**

The European public assessment report (EPAR) will be revised to implement the change in MAH.

#### **Reference**

- EPARs

**19.15. Who should I contact if I have a question when preparing my application or during the procedure? Rev. Jul 2021**

If you cannot find the answer to your question in the Q&A when preparing your application, please contact us by raising a ticket via EMA Service Desk, using the question option. The type of question to be selected is "Post-authorisation queries", followed by the sub-option "MAH transfer".

If you do not have an EMA Account, you may create one via the EMA Account Management portal. For further information or guidance about how to create an EMA Account reference the guidance "Create an EMA Account". If you have any questions about registrations, please send an e-mail to [Reset.Password@ema.europa.eu](mailto:Reset.Password@ema.europa.eu). Failure to register may cause delay in communication.

The Agency aims to respond to your query within 10 working days. To help us deal with your enquiry, please provide as much information as possible including the name of the product in your correspondence.

Transfers will be handled by a dedicated team of Procedure Managers (PM). A PM will be nominated upon receipt of the application. This allocated PM will be the contact point for this procedure.

## 20. Transparency

Since the establishment of EMA, transparency has been an important feature of the Agency's operation. This resulted in the introduction of the European Public Assessment Reports (EPARs) in line with the requirements of the Union legislation. European Union (EU) law sets the minimum level of transparency that the Agency must apply. However, in many areas, the Agency has decided to go beyond what law requires, so that it can provide as much information to the public as possible. In all cases, it takes care to balance this with the protection of commercially confidential information and personal data.

An overview of the EMA transparency measures are presented on the Transparency page on EMA's website.

The Agency has also published a guide to information on human medicines evaluated by EMA which describes the different types of information the Agency currently publishes for both centrally and non-centrally authorised medicines, as well as publication times and location on EMA's website. The guide aims to help stakeholders know what kind of information to expect on medicines undergoing evaluations and other regulatory procedures.

In addition, the public has the right to request information and documents from the Agency in accordance with its rules on access to documents.

### **20.1. Which EMA transparency measures apply for on-going marketing authorization application procedures? *Rev. Aug 2016***

Information on on-going medicine evaluations is published on EMA's website under Find Medicine-Medicines under evaluation. Information published relates to the INNs and therapeutic areas for each medicine under evaluation.

For more detailed information please refer to the guide to information on human medicines evaluated by EMA which describes all the information publicly available for on-going procedures.

### **20.2. Which transparency measure applies for the publication of assessment reports? *Rev. Aug 2016***

For information on the publication of assessment reports including a description of the documents that the EPAR comprises, all the circumstances that require an update of the EPAR and the information available before an EC decision is issued please refer to the Guide to information on human medicines evaluated by EMA. This guide also includes tabulated overviews of EMA documents, including their location and publication time.

**20.3. Which transparency measures apply with regard to the clinical data submitted by applicants/MAHs to support their regulatory applications?**  
**NEW May 2017**

Clinical data submitted by applicants/MAHs to support their marketing authorisation applications or applications for extension or modification of indication and line extensions is published on the Agency's clinical data publication website. This is a result of the implementation of the Agency policy on the publication of clinical data (Policy 0070).

For more detailed information on the clinical data published by the Agency, please refer to the clinical data publication page on the EMA's website.

Access to unpublished clinical data can be requested by completing the online form. For further information, see the guide on access to unpublished documents. This is in accordance with Regulation (EC) No 1049/2001.

**20.4. Which transparency measures apply with regard to EMA's scientific committees?** **NEW Aug 2016**

For transparency measures regarding the publishing of agendas, minutes and meeting highlights/reports for the different EMA's committees, please refer to the Guide to information on human medicines evaluated by EMA.

**20.5. Which specialised databases are publicly available?** **Rev. Aug 2016**

- Side effects of medicines

Information on suspected side effect reports is available in the European database of suspected adverse drug reaction reports. This website allows users to view the total number of individual suspected side effect reports submitted to the EudraVigilance database for each centrally authorised medicine and also for some active substances contained in nationally authorised medicines. Users can sort the suspected side effect reports by age group, sex, type of suspected side effect and outcome.

- Clinical trials

The EU Clinical Trials Register contains information on interventional clinical trials on medicines conducted in the European Union (EU), or the European Economic Area (EEA), including therefore also Iceland, Liechtenstein and Norway, which started after 1 May 2004.

Clinical trials conducted outside the EU/EEA are included if:

- they form part of a paediatric investigation plan (PIP), or
- they are sponsored by a marketing authorisation holder and involve the use of a medicine in the paediatric population as part of an EU marketing authorisation.

The EU Clinical Trials Register also displays information on more than 18000 older paediatric trials, which were completed by 26 January 2007 (in scope of Article 45 of the Paediatric Regulation (EC) No 1901/2006).



- GMP and GDP inspections

Information on inspections of manufacturers, importers and distributors as well as their authorisations and registrations issued by regulatory authorities are available in a public database called EudraGMDP.

- ENCePP database

The European Network of Centres for Pharmacoepidemiology and Pharmacovigilance (ENCEPP) is a network coordinated by the European Medicines Agency (EMA). The members of this network (the ENCePP partners) are public institutions and contract and research organisations (CRO) involved in research in pharmacoepidemiology and pharmacovigilance. Research interests are not restricted to the safety of medicines but may include the benefits and risks of medicines, disease epidemiology and drug utilisation. Participation to ENCePP is voluntary.

ENCEPP aims to strengthen the monitoring of the benefit-risk balance of medicinal products in Europe by:

- Facilitating the conduct of high quality, multi-centre, independent post-authorisation safety studies (PASS) with a focus on observational research;
- Bringing together expertise and resources in pharmacoepidemiology and pharmacovigilance across Europe and providing a platform for collaborations;
- Developing and maintaining methodological standards and governance principles for research in pharmacovigilance and pharmacoepidemiology.

The ENCePP website hosts the EU PAS Register which is a publicly available register of non-interventional post-authorisation safety studies (PASS). The Register has a focus on observational research, and its purpose is to increase transparency, reduce publication bias, promote the exchange of information and facilitate collaboration among stakeholders, including academia, sponsors and regulatory bodies, and ensure compliance with EU pharmacovigilance legislation requirements. Information on post-authorisation efficacy studies (PAES) that are not clinical trials (i.e. outside the scope of Directive 2001/20/EC ) should also be entered in the EU PAS Register to support transparency on post-authorisation efficacy studies (PAES), whether they are initiated, managed or financed by a marketing authorisation holder voluntarily or pursuant to an obligation.

- Parallel distribution notices

The public register of parallel distribution notices, launched in July 2015, provides up-to- date information on parallel distribution notices currently held by EMA.

## **20.6. Does EMA provide monthly figures on centralised procedures for human medicines? *Rev. Aug 2016***

Monthly Statistics reports on medicinal products for human use (with latest cumulative figures for the current year) are published on EMA's website. These documents provide current information related to the volume and outcomes of evaluations of marketing authorisation and post-authorisation applications received by EMA. The purpose is only to provide on-going factual information. Commentaries and analysis are provided in the EMA's annual reports.

The published Monthly Statistics reports can be found on the EMA's website under News and events-Statistics.

## References

- [Guide to information on human medicines evaluated by EMA](#)

## 21. Pharmacovigilance system summary

### 21.1. Requirements regarding the summary of the pharmacovigilance system *Rev. Jan 2016*

Applicants for marketing authorisation are required to provide a summary of their pharmacovigilance system, in accordance with Article 8(3)(ia) of Directive 2001/83/EC, which they will introduce once the authorisation is granted .

The requirement for the summary of the pharmacovigilance system was introduced by the new pharmacovigilance legislation (Directive 2010/84/EU amending, as regards pharmacovigilance, Directive 2001/83/EC).

The summary of the pharmacovigilance system should be provided in Module 1.8.1 of the application for marketing authorisation and includes the following elements:

- proof that the applicant has at his disposal a qualified person responsible for pharmacovigilance,
- the Member States in which the qualified person resides and carries out his/her tasks,
- the contact details of the qualified person,
- a statement signed by the applicant to the effect that the applicant has the necessary means to fulfil the tasks and responsibilities listed in Title IX of Directive 2001/83/EC,
- a reference to the location where the pharmacovigilance system master file (PSMF) for the medicinal product is kept.

The MAH may combine this information in one single statement using the required statement as per Article 8(3)(ia) of Directive 2001/83/EC regarding the obligation to have the necessary means to fulfil the tasks and responsibilities listed in Title IX (Pharmacovigilance). Such statement should be signed by an individual who can act on behalf of the legal entity of the applicant/MAH and by the qualified person responsible for pharmacovigilance (QPPV). The title, role and responsibility of each individual signing the statement should be clearly specified in the document.

The summary of the pharmacovigilance system is specific to each application/marketing authorisation as per the legislation and therefore should be signed by the relevant applicant/MAH. The requirement for the summary of the pharmacovigilance system is the same for any marketing authorisation application, independent of the legal basis for the application.

#### References

- Directive 2001/83/EC
- Directive 2010/84/EU
- Commission implementing Regulation (EU) No 520/2012 of 19 June 2012 on the performance of pharmacovigilance activities provided for in Regulation (EC) No 726/2004 of the European Parliament and of the Council and Directive 2001/83/EC of the European Parliament and of the Council
- European Commission Question and answers on transitional arrangements concerning the entering into force of the new pharmacovigilance rules provided by Directive 2010/84/EU amending

Directive 2001/83/EC and Regulation (EU) No 1235/2010 amending Regulation (EC) No 726/2004 (SANCO/D5/FS/(2012)1014848)

- HMA-EMA Questions and answers on practical transitional measures for the implementation of the pharmacovigilance legislation (EMA/228816/2012 – v.3)
- Guideline on good pharmacovigilance practices - Module I – Pharmacovigilance systems and their quality systems (EMA/541760/2011)
- Guideline on good pharmacovigilance practices - Module II – Pharmacovigilance system master file (EMA/816573/2011)

### **21.2. Requirements regarding the pharmacovigilance system and pharmacovigilance system master file *NEW March 2013***

The MAH has to operate a pharmacovigilance system for the fulfilment of his pharmacovigilance tasks.

The pharmacovigilance system master file (PSMF) is a detailed description of the pharmacovigilance system used by the MAH with respect to one or more authorised medicinal products.

The PSMF is not part of the marketing authorisation (MA) dossier and is maintained independently from the MA. It should be permanently available for inspection and should be provided within 7 days to the Competent Authorities if requested. The PSMF must be located either at the site in the Union where the main pharmacovigilance activities of the marketing authorisation holder are performed or at the site in the Union where the QPPV operates. The QPPV has to both reside and operate in the Union.

Applicants are required, at the time of initial MA application (MAA), to have in place a description of the pharmacovigilance system that records the system that will be in place and functioning at the time of granting of the MA and placing of the product on the market. During the evaluation of a MAA the applicant may be requested to provide a copy of the PSMF for review.

The PSMF has to describe the pharmacovigilance system in place at the current time. Information about elements of the system to be implemented in future may be included, but these should be clearly described as planned rather than established or current.

The pharmacovigilance system will have to be in place and functioning at the time of granting of the MA and placing of the product on the market.

#### **References**

- Directive 2001/83/EC
- Guideline on good pharmacovigilance practices - Module II – Pharmacovigilance system master file (EMA/816573/2011)

### **21.3. Subcontracting pharmacovigilance activities *NEW March 2013***

The MAH may subcontract certain activities of the pharmacovigilance system to third parties. It shall nevertheless retain full responsibility for the completeness and accuracy of the pharmacovigilance system master file (PSMF).

The MAH will have to draw up a list of its existing subcontracts between himself and the third parties, specifying the product(s) and territory(ies) concerned.

When delegating any activities concerning the pharmacovigilance system and its master file, the MAH retains ultimate responsibility for the pharmacovigilance system, submission of information about the PSMF location, maintenance of the PSMF and its provision to competent authorities upon request. Detailed written agreements describing the roles and responsibilities for PSMF content, submissions and management, as well as to govern the conduct of pharmacovigilance in accordance with the legal requirements, should be in place.

For more guidance on the requirements for pharmacovigilance system and PSMF, please refer to the relevant Good Pharmacovigilance Practice (GVP) Modules.

## References

- Guideline on good pharmacovigilance practices - Module I – Pharmacovigilance systems and their quality systems (EMA/541760/2011)
- Guideline on good pharmacovigilance practices - Module II – Pharmacovigilance system master file (EMA/816573/2011)

### **21.4. How to inform the authorities of a change in the summary of the pharmacovigilance system? *Rev. Jan 2016***

As of 1 February 2016, changes to the summary of the pharmacovigilance system – changes in QPPV (including contact details) and/or changes in the Pharmacovigilance Master File (PSMF) location are to be notified to the authorities through the Art 57 database only without the need for any further variation. From that date MAHs are not required to notify EMA or national competent authorities (as applicable) of changes to the QPPV or PSMF data by submitting a type IA<sub>IN</sub> variation.

Upon a change in the QPPV or location of the PSMF, the Art 57 database should be updated by the MAH immediately to allow continuous supervision by the Competent Authorities.

## References

- News item: Regulatory information – Green light for reliance on Article 57 database for key pharmacovigilance information on medicines for human use in Europe
- Art. 57 Reporting requirements for Marketing Authorisation Holders
- Detailed Guidance on electronic submission of information on medicines
- Volume 2C of the Rules Governing Medicinal Products in the European Union - Guidelines on the details of the various categories of variations, on the operation of the procedures laid down in Chapters II, IIa, III and IV of Commission Regulation (EC) No 1234/2008 of 24 November 2008 concerning the examination of variations to the terms of marketing authorisations for medicinal products for human use and veterinary medicinal products and on the documentation to be submitted pursuant to those procedures

**21.5. Is it mandatory to enter and maintain the location of the Pharmacovigilance System Master File in the XEVMPD? If so, how do we enter this information in the XEVMPD? NEW Jan 2016**

Please refer to question "Is it mandatory to enter and maintain the Location of the Pharmacovigilance System Master File in the XEVMPD? If so, how do we enter this information in the XEVMPD?" in the pre-authorisation guidance.

**21.6. Is the information on the Deputy QPPV required as part of the summary of the pharmacovigilance system? Rev. Jan 2016**

Please refer to question "Is the information on the Deputy QPPV required as part of the summary of the pharmacovigilance system?" in the pre-authorisation guidance.

**21.7. Is there a PSMF template? NEW Jan 2016**

Please refer to question "Is there a PSMF template?" in the pre-authorisation guidance.

**21.8. Pharmacovigilance System Master File location: can the server of the Pharmacovigilance System Master File be physically located and administered outside EU if it is validated and operational/accessible 24/7 for EU markets and EU QPPV? New Jan 2016**

Please refer to question "Pharmacovigilance System Master File location: can the server of the Pharmacovigilance System Master File be physically located and administered outside EU if it is validated and operational/accessible 24/7 for EU markets and EU QPPV?" in the pre-authorisation guidance.

**21.9. What information will be made public on the EU web-portal regarding pharmacovigilance contact details and PSMF locations? Will details of the QPPV be made public? New Jan 2016**

Please refer to question "What information will be made public on the EU web-portal regarding pharmacovigilance contact details and PSMF locations? Will details of the QPPV be made public?" in the pre-authorisation guidance.

## 22. Article 61(3) Notifications

### 22.1. What are Article 61(3) Notifications? *Rev. Apr 2021*

Article 61(3) refers to Directive 2001/83/EC in which a so-called “61(3) Notification” is defined as a change to an aspect of the Labelling and/or Package Leaflet (PL) text not connected with the Summary of Product Characteristics (SmPC).

In order for a 61(3) Notification to be valid:

- the change must affect only the Annexes IIIA (labelling) and/or IIIB (PL), with no changes to the SmPC and/or the Annex II. In addition,
- the changes must affect the English labelling and/or PL text, with consequential amendments to all other language versions.

Examples of changes falling within the scope of 61(3) Notification:

- Changes in the local representatives
- Minor changes to the labelling and/or PL
  - Labelling: e.g. changes of abbreviation for the batch number
  - PL: Harmonisation of wording used in the PL
- Updated PL after User Testing when the User Testing report and amended leaflet cannot be included in an upcoming regulatory procedure which affects the Annexes (e.g. Type II variation)
- Introduction of combined PL (after prior consultation with QRD)
- Change in Braille (inclusion/deletion/change)
- Change in instruction for use in the PL

The following examples **do not** fall within the scope of 61(3) Notification:

- Changes to SmPC or Annex II,
- Changes that only affect some languages but not all,
- Changes in overall lay-out, design, readability of labelling and/or PL with no changes to the text. *In such case, the need for an EMA review of the proposed changes by means of the provision of specimens, should be discussed with EMA ([muspecimens@ema.europa.eu](mailto:muspecimens@ema.europa.eu)), as outlined in “Checking Process of Mock-Ups and Specimens of outer/immediate labelling and package leaflets of human medicinal products in the Centralised Procedure” on the EMA website.*

It is possible to introduce within a single 61(3) Notification, several changes to the labelling and/or the package leaflet, which do not affect the SmPC or the Annex II (e.g. submission of a change in the local representative and harmonisation of the wording used in the PL).

The Agency strongly recommends, that whenever possible, the marketing authorisation holder (MAH) includes minor changes to the labelling and/or PL as part of another on-going or upcoming regulatory procedure amending the Product Information (e.g. Type IA\*, Type IB or II variation affecting the product information, renewal, etc.). Should the MAH have a query on changes that may fall under the scope of 61(3) Notification they should contact the EMA Service Desk, using the Question option. The

Type of question to be selected is "Post-authorisation queries", followed by sub-option "Article 61(3) Notification". If you do not have an EMA Account, you may create one via the EMA Account Management portal.

However, if submitted stand-alone, changes only affecting Annex III have to be submitted as a 61(3) Notification (i.e. not possible to submit as a variation).

Upon submission, the Agency will inform the marketing authorisation holder (MAH) within 90 days whether the proposed changes are accepted or not. The Agency will inform concomitantly the Commission in cases where the changes have been accepted (for information on the update of the Commission Decision see: How and when will the updated Annexes become part of the Marketing Authorisation?).

\*Only changes for which no rapporteur involvement, nor linguistic review is needed (e.g. change to local representatives).

### **References**

- Directive 2001/83/EC
- The Revised Checking Process of Mock-Ups and Specimens of outer/immediate labelling and package leaflets of human medicinal products in the Centralised Procedure (EMEA/305821/2006)

## **22.2. Is the Rapporteur involved in 61(3) Notifications?**

The Rapporteur is normally not involved in the review of a 61(3) Notification. However, the Rapporteur may be involved on a case-by-case basis depending on the changes requested (e.g. extensive PL revision following User Testing).

## **22.3. When can I submit my 61(3) Notification? *Rev. Feb 2021***

There are no recommended submission dates for 61(3) Notifications. Hence, the MAH can submit a 61(3) Notification at any time.

The Agency strongly recommends that whenever possible the marketing authorisation holder (MAH) includes these minor changes to the labelling and/or PL as part of another on-going or upcoming regulatory procedure amending the Product Information (e.g. Type IA\*, Type IB or II variation affecting the product information, renewal, etc.). Should the MAH have a query on changes that may fall under the scope of 61(3) Notification they should contact the EMA Service Desk, using the Question option. The Type of question to be selected is "Post-authorisation queries", followed by sub-option "Article 61(3) Notification".

If you do not have an EMA Account, you may create one via the EMA Account Management portal.

\* Only changes for which no rapporteur involvement, nor linguistic review is needed (e.g. change to local representatives).



## **22.4. How shall I present my 61(3) Notification? Rev. Apr 2021**

The submission of a 61(3) Notification should include:

### **22.4.1. Cover Letter indicating the product name**

- dated, signed by the official contact person,
- including a summary and / or explanation of the proposed changes
- including a list of on-going/upcoming regulatory procedures affecting the Annexes and including a confirmation that the proposed changes only affect Annex III).
- including a confirmation from the MAH that there are no other changes than those identified in the cover letter (except for those addressed in other variations submitted in parallel),
- present/proposed table of the changes (this can be a separate annex).

### **22.4.2. Product information**

- The revised product information ('complete set of Annexes' includes Annex I, II, IIIA and IIIB i.e. all SmPC, labelling and PL texts for all approved strengths and pharmaceutical forms of the product concerned) in all EU languages (incl. IS+NO)
  - in Word format (highlighted) indicated via 'Tools – Track changes'
  - in PDF format (clean) with all changes 'accepted'
- Please be reminded that in accordance with Union data protection requirements, no personal data should be included in the annotated product information annexes. This applies to the English version and all the translations. Please submit annotated product information annexes in an anonymised format (i.e. names of the reviewers removed from the track-changes). If you do not wish to do so, please ensure that the individuals whose data is included consented to its sharing with EMA and its further sharing by EMA with third parties such as other marketing authorisation applicants, marketing authorisation holders and National Competent Authorities, as relevant. EMA expressly disclaims any liability or accountability for the presence of unnecessary personal data in the annotated product information annexes submitted by the marketing authorisation holder.

The complete set of Annexes must be presented sequentially (i.e. Annex I, II, IIIA, IIIB) as one document for each official EU language. Page numbering should start with "1" (bottom, centre) on the title page of Annex I. The Annexes should be presented in strict compliance with the QRD Convention published on the EMA website. When submitting the full set of Annexes in PDF format, this should be accompanied by the completed formatting checklist, and MAHs should follow/pay attention to the guidance on how to correctly prepare the PDF versions.

The Annexes should be presented on the latest CHMP approved version.

The Annexes provided should only reflect the changes introduced by the 61(3) Notification. However, it is possible for the MAHs to take the opportunity to introduce minor linguistic amendments in the labelling and/or the PL for all or some EU languages. These changes should be clearly mentioned in the cover letter. Any changes not listed in the Notification cover letter will not be considered as part of the 61(3) Notification. In addition, it is not possible for the MAHs to introduce minor linguistic amendments in the SmPC and/or the Annex II.

### 22.4.3. If applicable

- Any supportive relevant documentation [e.g.: User Testing reports English and multi-lingual ('worst-case') colour mock-up of outer and immediate packaging for each pharmaceutical form in each container type (e.g. blister and bottle, vial and pen) in the smallest pack-size] to the 61(3) Notification, presented under the appropriate headings and numbering of the EU-CTD format.

### 22.5. How and to whom shall I submit my 61(3) Notification? **Rev. Feb 2019**

Information is available on 'Submitting a post-authorisation application'.

### 22.6. How shall my 61(3) Notification be handled (timetable), and what could be the outcome? **Rev. Feb 2021**

A dedicated Procedure Manager (PM) will be assigned to the procedure once your notification has been submitted.

#### 22.6.1. Timelines

The length of the procedure will vary depending on the need for Rapporteur's involvement, linguistic review and the submission of revised information by the MAH when required. If the EMA 61(3) Notification is not issued within 90 days following the introduction of the request, the applicant may put the change into effect.

#### 22.6.2. Process

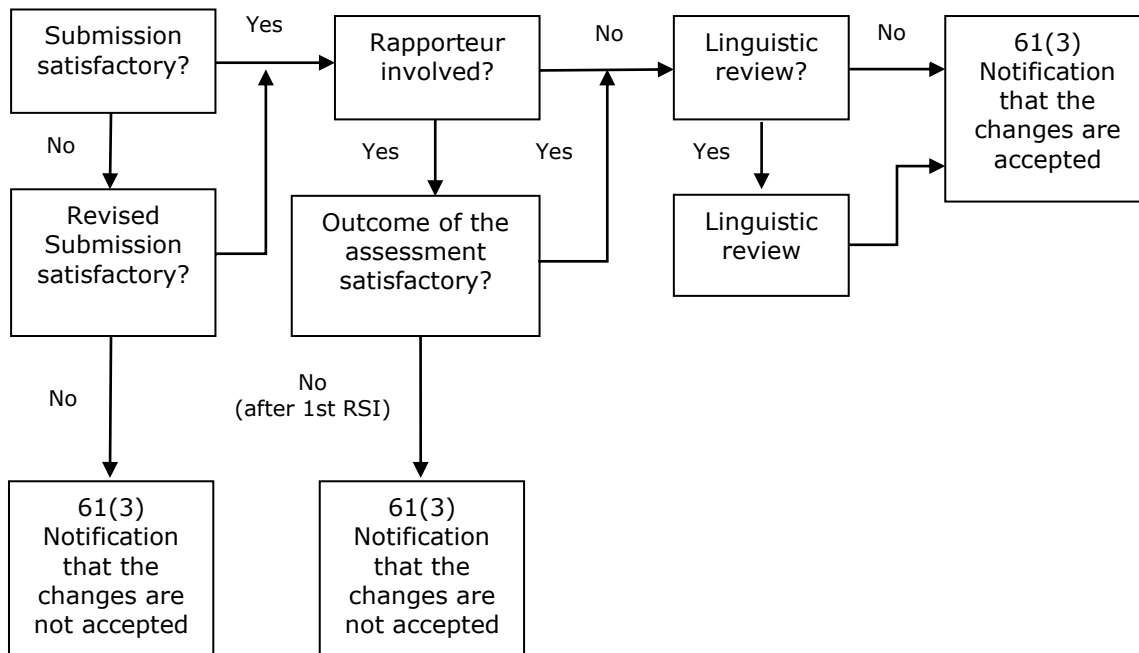

- Upon submission of your 61(3) Notification, the PM will review the content of the documentation.
- When the documentation submitted by the MAH does not meet the requirements, the PM will contact the MAH. The MAH should then provide revised documentation within 5 days. Upon receipt of the revised documentation, the PM will review the information. Should the information provided by the MAH be incomplete or does not fall under the scope of 61(3) Notification, the PM will inform the MAH that the proposed change cannot be implemented.
- Upon receipt of satisfactory documentation and in cases where the Rapporteur's input is needed (e.g. submission of user testing results), the Rapporteur will assess the MAH's proposal within 15 working days. Should the outcome of the Rapporteur's assessment be not satisfactory, the MAH will be requested to provide revised documentation within 5 days. Upon assessment of the MAH's responses, should the outcome of the Rapporteur's assessment remain unsatisfactory, the PM will inform the MAH that the proposed change cannot be implemented.
- Once the proposed changes have been agreed and the linguistic review is complete (when applicable), the MAH will receive a 61(3) Notification via email that the changes have been accepted.

### **22.6.3. Possible outcomes**

In summary, the following outcomes may be envisaged for 61(3) Notification:

- Changes are acceptable and an EMA 61(3) Notification is issued within a maximum of 90 days.
- Changes are not acceptable (even after receipt of additional/revised information if required). The PM will inform the MAH that the proposed change cannot be implemented.
- The proposed changes do not fall under the scope of a 61(3) Notification (even after receipt of additional/revised information if required). The PM will inform the MAH that the change does not fall under the scope of Article 61(3) and cannot be processed. The proposed change cannot be implemented.

### **22.7. What fee do I have to pay for a 61(3) Notification?**

There is no fee payable for 61(3) Notifications.

### **22.8. Do I have to submit mock-ups and specimens? *Rev. Aug 2014***

#### **22.8.1. Mock-ups**

In principle, no mock-ups are to be provided with 61(3) Notifications, however, where the overall design and readability of the outer and immediate packaging and/or package leaflet is affected as part of the 61(3) Notification, the need for the provision of mock-ups should be discussed with the EMA ([muspecimens@ema.europa.eu](mailto:muspecimens@ema.europa.eu)) on a case-by-case basis (e.g. mock-ups would be required when proposing a new corporate design of packs, use of different colours, major changes in layout, introduction of new text in the labelling in line with the SmPC).

In case the submission of mock-ups is required, the relevant example mock-ups would need to be included in the module 1.3.2 of the application dossier.

In case of comments on the mock-ups, the MAH should submit responses and/or updated mock-ups, as applicable, to the EMA (muspecimens@ema.europa.eu) prior to the specimens printing. EMA will discuss the best and feasible corrective action with the MAH, taking into account the nature and amount of issues identified. EMA will endeavour to provide such feedback as soon as possible and taking into consideration the production plan of the medicinal product, as applicable.

### **22.8.2. Specimens**

Where the overall design and readability of the outer and immediate packaging and/or package leaflet is affected as part of the 61(3) Notification, the need for the provision of specimens should be discussed with the EMA Medical Information Sector on a case-by-case basis (e.g. specimens would be required when proposing major changes in lay-out, use of different colours as part of the 61(3) Notification, but not e.g. when only limited text is added/revised in a PL section).

In case specimens are required, in principle only one relevant example (multi-lingual if possible) would need to be sent to the EMA at the latest 15 working days before marketing. However, depending on the nature and extent of the change(s) concerned, additional specimens may be required by the EMA. The EMA will perform a general check from the viewpoint of readability within 15 working days and will check if any previous comments on specimens have been duly implemented. The MAH will be informed about the outcome of the check.

### **22.8.3. Note**

In case the MAH wishes to receive EMA feedback on their proposed new packaging in advance of the specimen review, the EMA could agree with the MAH on a case-by-case basis, to review draft mock-ups before specimen submission.

The above principles also apply to mock-ups for Iceland. The mock-ups should be sent to mockups@ima.is. See also <http://www.ima.is/>.

No mock-ups and specimens are required for Norway.

### **References**

- Checking Process of Mock-Ups and Specimens of outer/immediate labelling and package leaflets of human medicinal products in the Centralised Procedure (EMEA/305821/2006 Rev 1)

## **22.9. How and when will the updated Annexes become part of the Marketing Authorisation? *Rev. Aug 2014***

Upon finalisation of a 61(3) Notification, the changes to the product information Annexes will be reflected in the framework of the next regulatory procedure for which a Commission Decision will be issued. For example, the changes could be included with the Commission Decision of a subsequent Type II variation.

However, the agreed changes can be implemented upon receipt of the EMA 61(3) Notification without awaiting the update of the Marketing Authorisation through a Commission Decision, and the agreed changes should be included in the Annexes of any regulatory procedure subsequent to the 61(3)

Notification. Additionally, if the EMA 61(3) Notification is not issued within 90 days following the introduction of the request, the applicant may put the change into effect.

**22.10. Will there be any publication on the outcome of my 61(3) Notification? *Rev. Apr 2012***

The EPAR (published on the EMA website) will be revised to implement the outcome of the 61(3) Notification, after issuance of the EMA 61(3) Notification.

**References**

- EPARs

**22.11. Who is my contact at the European Medicines Agency during post-authorisation procedures? *Rev. Feb 2019***

Information is available on 'Contacting EMA: post-authorisation'.

## 23. Marketing status updates

### **23.1. What is the meaning of "actual marketing" / "placing on the market"? Rev. Jul 2021**

- In accordance with Article 13(4) of Regulation (EC) No 726/2004, Marketing Authorisation Holders are required to inform EMA of the date(s) of actual marketing of their centrally-authorized product on the Union Market.
- The actual marketing corresponds to the "placing on the market" which is defined in Chapter 1 of volume 2A of the Notice to Applicants as the date of release into the distribution chain i.e. out of the direct control of the Marketing Authorisation Holder. This also applies to the placing on the market following a marketing cessation.

For centrally-authorized medicinal products "marketed" means that at least one presentation of the medicinal product is at least marketed in one Member State of the Union.

#### **References**

- Article 13(4) of Regulation (EC) No 726/2004
- Article 23a of Directive 2001/83/EC, as amended
- Chapter 1 (section 2.4.2), The Rules governing Medicinal Products in the European Union, Notice to Applicants, Volume 2A

### **23.2. What is the meaning of "cessation of placing on the market"? Rev. Jul 2021**

In accordance with Article 13(4) of Regulation (EC) No 726/2004, Marketing Authorisation Holders are required to inform EMA if their centrally-authorized product ceases to be placed on the market of a Member State, either temporarily or permanently.

By analogy to the placing on the market, the "cessation of placing on the market" or "marketing cessation" is defined in the general principles outlined in the Chapter 1 of volume 2A of the Notice to Applicants, as the "cessation of release into the distribution chain" with the consequence that the concerned product may no longer be available for the supply to the patients.

The date of marketing cessation shall be the date of the last release into the distribution chain.

#### **References**

- Article 13(4) of Regulation (EC) No 726/2004
- Article 23a of Directive 2001/83/EC, as amended
- Chapter 1 (section 2.4.2), The Rules governing Medicinal Products in the European Union, Notice to Applicants, Volume 2A

### **23.3. What is the aim of monitoring the marketing status of medicinal products? Rev. Jul 2021**

Monitoring the marketing status of medicinal products in the EU allow for the application of Article 24(4) to (6) of Directive 2001/83/EC and Article 14(4) to (6) of Regulation (EC) No 726/2004 ("monitoring of the sunset clause" (See also Q&A on Sunset clause monitoring).

This marketing status reporting also aims to increase transparency on availability of medicinal products across the Union and to enable EMA and National Competent Authorities to consider the need for action in different Member States or at EU level to protect Public Health.

### **23.4. What information should be reported to the Agency on the marketing status of CAPs? Rev. Feb 2022**

- The **actual marketing** of a centrally-authorized medicinal product (CAP) shall be reported to the Agency per presentation and per Member State (see question What is the meaning of "actual marketing" / "placing on the market"?). Of note, for centrally authorised medicinal products, presentation corresponds to pack-size.
- MAHs shall also report to the Agency any **marketing cessation** (temporary/permanent) of their medicinal product per presentation and per Member State. This also includes **suspension or withdrawal of a medicinal product from the EU market**, or decision to **withdraw the marketing authorisation** or **not to apply for the renewal** of a marketing authorisation. The MAH should specify the reasons for such action and particularly if this is solely based on a commercial decision or related to any of the reasons listed in Articles 116 and 117 of Directive 2001/83/EC (e.g. quality, efficacy, safety reasons). When the marketing cessation or withdrawal is due to reasons listed in Articles 116 and 117, MAHs should also notify the EMA of actions undertaken in third countries.

In case of a temporary marketing cessation, the anticipated reintroduction date needs to be provided.

MAHs are advised that when cessation/suspension/withdrawal is due to efficacy, safety and/or quality related issues for which already particular procedures are established, reporting of such cessation in IRIS is without prejudice to applying the other specific related procedures (e.g. quality defect, pharmacovigilance reporting, etc.), in parallel, as appropriate:

- In case of an emerging safety issue (ESI), should the MAH decide to take any action with regards to the marketing of the medicinal product or to the marketing authorisation of this medicinal product, the notification of such action to the Agency should be done in parallel to the notification to the ESI mailbox (P-PV-emerging-safety-issue@ema.europa.eu).
- In case of a quality defect, should the MAH decide to take any action with regards to the marketing of the medicinal products or to the marketing authorisation of this medicinal products, the MAH should complete the published Defective Product Report Form, specifying in which country(ies) the action(s) is/are taken and the anticipated date(s) as to when the medicinal product is no longer available on the market of the concerned country(ies). The form should be sent to qdefect@ema.europa.eu as detailed in Notifying quality defects or products recalls.
- When reporting a marketing cessation, MAHs will be asked to clarify whether they anticipate a risk of shortage. MAHs should provide such information to the best of their knowledge at time of

reporting a marketing cessation. This information will not replace existing processes to report shortages to EMA. This is only intended to facilitate dissemination of the information within EMA and EU Network.

- In case of a voluntarily request from the MAH to withdraw a marketing authorisation, the MAH should send a letter to the European Commission to request a withdrawal of the marketing authorisation and provide a copy of the letter to the Product Lead, Product mailbox, Withdrawn product mailbox, Rapporteurs and CHMP Chair. (See question *How should I request the withdrawal of my central marketing authorisation?*)
- For medicinal products authorised in a paediatric indication and for which the MAH has benefited from rewards or incentives under the paediatric regulations, the MAH should inform the Product Lead, Product mailbox, Rapporteurs of its intention to discontinue the placing on the market of the product (see question *When to report the marketing status overview of centrally-authorised products to the Agency?*) explaining the actions they are undertaking to ensure the medicinal product remains available to EU paediatric patients (e.g. transfer of a marketing authorisation, informed consent), in accordance with Article 35 of Regulation (EC) No 1901/2006. See question *Is there an obligation to market a medicine which is authorised for a paediatric indication, following completion of an agreed paediatric investigation plan, and the product has already been marketed with other indications?*

## References

- Article 13(4) of Regulation (EC) No 726/2004
- Articles 116 and 117 of Directive 2001/83/EC
- Article 35 of Regulation (EC) No 1901/2006
- Chapter 1 (section 2.4.2), The Rules governing Medicinal Products in the European Union, Notice to Applicants, Volume 2A.

### **23.5. When to report the marketing status overview of centrally-authorised products to the Agency? Rev. Jul 2021**

The so-called marketing status overview refers to the picture of the marketing situation of a specific medicinal product, at one time point of the product lifecycle, per presentation and per Member State. As of July 2021, the EMA is using the IRIS database to collect the marketing status notifications for centrally-authorised products and to provide an up-to-date overview to the EU Member States. (see question *How to report marketing status updates to the Agency for CAPs?*)

MAHs should inform the Agency of the marketing status of their centrally authorised medicinal product(s), at the time of the initial placing on the market and for any subsequent changes in marketing status (i.e. temporary marketing cessation, reintroduction on the EU market or permanent cessation), for each presentation and in each Member State, according to the timelines given hereafter:

- The MAH should notify the Agency within 30 days of the placing on the market, including the reintroduction on the market (i.e. placing on the market following a marketing cessation) of a medicinal product within the Union (i.e. per presentation and per Member State).



- The MAH should notify the Agency at least 60 days in advance, of a marketing cessation (temporary or permanent) at Member State level - unless the marketing cessation/suspension/withdrawal is related to the grounds listed in Articles 116 and 117 of Directive 2001/83/EC (e.g. quality, efficacy, safety issues) in that case the Agency should be notified immediately. MAHs should also inform the Agency immediately of marketing cessations undertaken in third countries due to reasons covered in Articles 116 and 117 of Directive 2001/83/EC (e.g. quality, efficacy, safety issues).
- The MAH should notify the Agency of their request to **withdraw their central marketing authorisation** at least 2 months in advance unless unforeseeable circumstances which may require an immediate notification (e.g. safety reasons). The update in IRIS would not replace the formal request to address to the European Commission (see question *How should I request the withdrawal of my central marketing authorisation?*). Of note, for medicinal products authorised in a paediatric indication and for which the MAH has benefited from rewards or incentives under the paediatric regulations, the MAH should inform the EMA of its intention to discontinue the placing on the market of the product at least 6 months before discontinuation. See question *Is there an obligation to market a medicine which is authorised for a paediatric indication, following completion of an agreed paediatric investigation plan, and the product has already been marketed with other indications?*
- The MAH should notify the Agency of their intent **not to apply for a renewal of their central marketing authorisation** at time of expected submission (i.e. at least 9 months prior to MA expiry). Notification in IRIS would not replace the need to inform the Product Lead in parallel (cc product mailbox).

Since the IRIS database is intended to be kept up to date with the marketing status of centrally authorised medicinal products, it is no longer needed to provide an annual update to the Agency at the time of anniversary of the Commission Decision on the central marketing authorisation. However, an overview of the marketing status of medicinal products is still expected to be provided within PSUR and renewal applications

## References

- Article 13(4) of Regulation (EC) No 726/2004
- Article 23a of Directive 2001/83/EC, as amended
- Articles 116 and 117 of Directive 2001/83/EC
- Article 35 of Regulation (EC) No 1901/2006

## **23.6. How to report marketing status updates to the Agency for CAPs? Rev. Feb 2022**

EMA used to receive notifications of placing on the market, marketing cessations and withdrawn product notifications by email.

As of end of July 2021, EMA requests MAHs of centrally-authorized products (CAPs) to submit their marketing status notifications via the IRIS platform.

- Newly authorised CAPS will be added progressively to IRIS with a status "Never marketed" by default. The MAH will be required to notify all changes to marketing status using the platform.

- CAPs that were authorised prior to the launch of IRIS Marketing Status, will have their marketing status in IRIS as 'No data provided':
- For authorised CAPs not yet marketed in any EU/EEA MS, MAHs should report the initial placing on the market of relevant presentations and any subsequent marketing status updates directly via the IRIS platform.
- For authorised CAPs already marketed in at least one EU/EEA MS, MAHs will progressively upload the marketing status of their CAPs in IRIS during a 9-months transition period (baseline data). Whilst it is allowed to report changes to the marketing status of their CAPs via the existing process (e-mails) during the transition period, once the baseline data have been submitted in IRIS, reporting of changes to the marketing status should continue in IRIS.

### **How to report marketing status updates via IRIS (new process that can be used as of end of July 2021)**

There are 3 possibilities to report updates on marketing status for a medicinal product:

- **Marketing Status Notification (Single)**

This function allows to report the same change in marketing status affecting one or more presentations of a CAP in one or more MS (e.g. placing on the market of 3 presentations in 5 Member States on the same day).

- **Marketing Status notification (bulk upload)**

This function enables to report several different changes in marketing status affecting one or multiple presentations in one or multiple MS, by uploading an excel spreadsheet (e.g. placing on the market of presentation B in CZ, AT and NL + marketing cessation of presentation A in IT on different dates).

- **Withdrawn product notifications** (affecting all presentations in all MS):

This function allows to report

- A request for **withdrawal of the central marketing authorisation** of your product (This would not replace the formal request to send to the European Commission, see question *How should I request the withdrawal of my central marketing authorisation?*)
- a **decision not to apply for the renewal of the marketing authorisation**
- a **permanent marketing cessation** affecting all presentations of a medicinal product in all MS. Of note, if the marketing authorisation is not withdrawn, it will automatically expire after 3 years of non-marketing under the sunset clause provision (see *Q&A on sunset clause provision*).

### **How do I submit baseline data for already authorized CAPs in IRIS?**

For CAPs already marketed in at least one EU/EEA MS, MAHs should progressively upload the marketing status of their CAPs in IRIS during a 9-months transition period (baseline data). To upload the baseline data, the same options available to report marketing status updates can be used, i.e. single or bulk upload. For detailed information on how to perform the submission, see IRIS technical guidance (sections 6.1 and 6.2).

When submitting the baseline for the first time, the marketing status will appear in IRIS as 'No data provided'.

- **Presentations already on the market:** status should be reported as 'Marketed' with the date of the initial placing in the market as 'Date of Marketing Status change'. This will become the 'Date of initial placing in the market' once the submission is processed.

Example: For product X, presentation 001 is currently in the market in ES and PT. Presentation 001 was first launched in ES on 01/01/1999 and in PT on 03/02/1999. By default the IRIS database reflects: "No data provided" for all presentations in all EU/EEA MS.

Report for 001 Status: Marketed. "Date of Marketing Status change" 01/01/1999 for ES and 03/02/1999 for PT. This will result in 01/01/1999 becoming the "Date of initial placing in the market" in ES and 03/02/1999 becoming the "Date of initial placing in the market" in PT.

In the exceptional situation where the launch date is unknown "01/01/1900" should be used.

- **Presentations that have never been marketed in at least one Member State** A specific Marketing Status category has been added for products that have never been on the market. 'Never marketed' should be chosen from the list of Marketing Status options. Reason for Cessation and the Date of Marketing Status change can be left blank. For newly authorised products, the default status will already be 'Never marketed'.

Example: Presentation 002 of Product X was never marketed in any MS and is currently showing as 'No data provided'. A Marketing Status change from 'No data provided' to 'Never marketed' should be submitted for presentation 002 for all MS. Date of Marketing Status change and Reason for Cessation can be left blank.

- **Presentations that were previously marketed** and for which the MAH would like to report a (temporary or permanent) marketing cessation as the current marketing status report through IRIS: this needs to be done in two steps: the initial placing on the market needs to be reported first before the marketing cessation can be reported.

Example: Presentation 003 of Product X was first placed in the market in Austria on 01.03.1995 and is permanently ceased from 01.03.2021. The MAH should report as a single or bulk upload a change in Marketing status to "Marketed" with "Date of Marketing Status change" as 01.03.1995. Once this case is processed, the MAH should report a change of marketing status as "Not Marketed" with "Date of Marketing Status change" as 01.03.2021.

EMA has prepared a technical guidance to help MAHs to submit their marketing status updates via IRIS.

For any question regarding your IRIS submission please contact EMA Service Desk.

**How to report marketing status updates via email (existing process to be discontinued from May 2022 for EU/EEA/UK(Northern Ireland)).**

During the 6-month transition period where IRIS is progressively being populated with marketing status data of CAPs, MAHs can continue to report the marketing status updates of their already marketed CAP via emails as per the existing process until the baseline data are submitted into IRIS:

- initial placing on the market in EU/EEA/UK(Northern Ireland) to be notified within 30 days to the mailbox marketingstatus@ema.europa.eu with the EMA Product Lead with the product mailbox in copy.
- marketing cessations or withdrawn product notifications (in EU/EEA/UK(Northern Ireland) to be notified to the Agency via the dedicated mailbox withdrawnproducts@ema.europa.eu using the

template cover letter and notification report table "Notification of withdrawn products" with the Product Lead, Product mailbox and the Rapporteur of the product in copy.

- Particular cases of Withdrawn product notifications related to Art 116 117 reasons (e.g. quality, efficacy, safety) in 3rd countries – please see question on "When and how to report to the Agency actions taken in 3rd countries?"

## References

- Article 13(4) of Regulation (EC) No 726/2004, as amended
- Article 14b of Regulation (EC) No 726/2004, as amended
- Article 16(2) of Regulation (EC) No 726/2004, as amended
- Article 35 of Regulation (EC) No 1901/2006, as amended
- Chapter 1 (section 2.4.2), The Rules governing Medicinal Products in the European Union, Notice to Applicants, Volume 2A

### **23.7. When and how to notify marketing cessations for nationally authorised products to the Agency? *NEW Jul 2021***

MAHs of nationally authorised products (NAPs) are required to inform the **relevant National Competent Authorities** of the marketing status of their medicinal products as per the requirements of Articles 23a and 123 of Directive 2001/83/EC, as amended. Notification to the competent authorities of the Member State(s) concerned should be submitted in accordance with the practices established at national level if applicable. Where national competent authorities have not provided particular instructions, the template cover letter and notification report table "Notification of withdrawn products" should be used.

MAHs of NAPs are also required to inform forthwith **the EMA** of any action taken by the holder, in a **EU/EEA Member State** or in a **3<sup>rd</sup> country**,

- to suspend the marketing of a medicinal product,
- to withdraw a medicinal product from the market
- to request the withdrawal of a marketing authorisation
- or not to apply for the renewal of a marketing authorisation,

when the reasons for such action are based on any of the grounds set out in Article 116 or Article 117(1) of Directive 2001/83/EC, as amended (e.g. related to efficacy, safety, quality and/or compliance issues).

Such notification should be made to the Agency through the dedicated mailbox [withdrawnproducts@ema.europa.eu](mailto:withdrawnproducts@ema.europa.eu) using the template cover letter and notification report table "Notification of withdrawn products", and to the Member State(s) concerned as applicable.

In case of an emerging safety issue (ESI), should the MAH decide to take any action with regards to the marketing of the medicinal product or to the marketing authorisation of this medicinal product, the notification of such action to the Agency should be done in parallel to the notification to the ESI mailbox ([P-PV-emerging-safety-issue@ema.europa.eu](mailto:P-PV-emerging-safety-issue@ema.europa.eu)).

## References

- Article 23a of Directive 2001/83/EC, as amended
- Article 123 of Directive 2001/83/EC, as amended

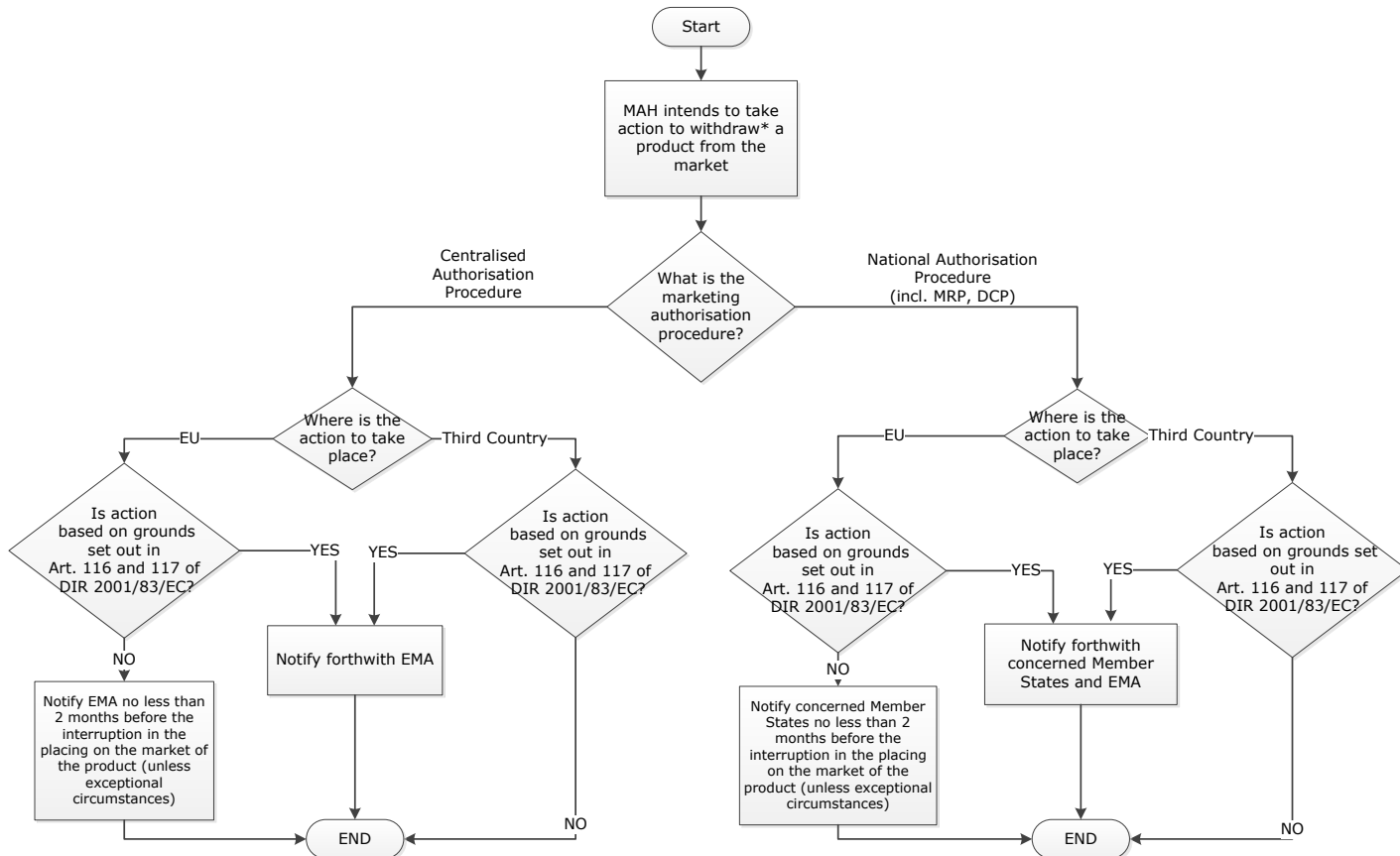

Actions to withdraw \* :

- cease temporarily or permanently the marketing of the product
- suspend the marketing of a medicinal product;
- withdraw a medicinal product from the market;
- request the withdrawal of a marketing authorisation;
- not to apply for the renewal of a marketing authorisation

## 23.8. How will the Agency inform the Member States? **Rev. Jul 2021**

As per the existing process, once the Agency receives a notification of a “withdrawn product” via email from a MAH whether this is for a centrally or nationally authorised medicinal product, the Agency forwards such notification to all Competent Authorities in the EEA without undue delay.

As of end of July 2021, EMA uses the IRIS database to collect marketing status updates in the different EU/EEA Member States including withdrawn product notifications for centrally-authorised products and this information will be accessible to the National Competent Authorities and the European Commission. Notifications of withdrawn products received by email for NAPs will continue to be forwarded to EEA Competent Authorities as per the existing process.

## References

- Article 14b of regulation (EC) No 726/2004, as amended

- Article 123 of Directive 2001/83/EC, as amended

### **23.9. How should I request the withdrawal of my central marketing authorisation? NEW Jul 2021**

The MAH should send by email a request for withdrawal of the marketing authorisation to the European Commission, Health and Food Safety Directorate-General, Unit B5 (SANTE-PHARMACEUTICALS-B5@ec.europa.eu) keeping in copy the EMA Product Lead, the CHMP/PRAC/CAT Rapporteurs (as applicable), Chairs and Vice chairs of relevant committees and the EMA withdrawn products mailbox (withdrawnproducts@ema.europa.eu).

The letter to the European Commission should cover the following points:

- Medicinal product concerned (name, EU number(s)...);
- The reason for the withdrawal of the marketing authorisation and whether or not it is based on the grounds provided in Articles 116 and 117 of Directive 2001/83/EC;
- The Member States where the product is currently marketed;
- The proposed effective date for the withdrawal of the MA. The withdrawal of the MA will become effective on the EC notification date by default (e.g. usually within two months of the MAH request), or by any date agreed with the European Commission and specified in the Commission decision withdrawing the marketing authorisation. The MAH is therefore invited to clarify in their request if they would like to suggest a withdrawal date more than the two-month after their request to withdraw the marketing authorisation.
- How the MAH will approach the continued use of any remaining product, as they will continue to be responsible for any remaining product on the market(s); The MAH should therefore ensure that any product remaining on the market has been produced according to current GMP standards and that the QP responsible for batch release remains fully responsible for any remaining product that may still be in the market, including continuous monitoring of any product defects. Further, the MAH should ensure that the Pharmacovigilance System is still fully active in monitoring any safety signals that may arise from the usage of the withdrawn product and that the QP responsible for Pharmacovigilance is still maintaining all responsibilities for the product (whilst stock remains).
- How and when the company plans to inform the public, doctors and pharmacists, as applicable;
- The therapeutic alternative available, if appropriate, and whether the planned withdrawal will allow physicians and patients adequate time to consider and transition to alternative therapies.
- For medicinal products authorised in a paediatric indication, the MAH should confirm whether Article 35 of Regulation (EC) No 1901/2006 would apply in their case and what actions they are undertaking to comply with the requirements of the Paediatric regulation to ensure the medicinal product remains available to EU paediatric patients.

Provided that the withdrawal is solely based on commercial reasons (i.e. the withdrawal of the marketing authorisation is not linked to underlying quality, safety, efficacy or benefit/risk issues), it is agreed at EU level that there is no need for batch recalls for CAPs, the medicinal product can remain on the EU market until expiry date. The MAH remains responsible for the batches on the market and for pharmacovigilance activities.

In parallel to the formal request made to the Commission, IRIS needs to be updated via the withdrawn product notification (see question “How to report marketing status updates to the Agency for CAPs?”).

#### **References**

- Article 13(4) of Regulation (EC) No 726/2004, as amended
- Article 14b of Regulation (EC) No 726/2004, as amended
- Article 16(2) of Regulation (EC) No 726/2004, as amended
- Article 35 of Regulation (EC) No 1901/2006, as amended

### **23.10. When and how to report to the Agency actions taken in 3<sup>rd</sup> countries? *NEW Feb 2022***

MAHs are also required to notify the EMA of any action taken outside the EEA to suspend the marketing of a medicinal product, to withdraw a medicinal product from the market, to request the withdrawal of a marketing authorisation or not to apply for the renewal of a marketing authorisation, when such action is based on any of the grounds set out in Article 116 or Article 117(1) (e.g. quality, safety or efficacy issue).

Such notification should continue to be made by email to [withdrawnproducts@ema.europa.eu](mailto:withdrawnproducts@ema.europa.eu) using the template cover letter and notification report table “Notification of withdrawn products” and with the Product mailbox and EMA Product lead in copy.

It is planned that these notifications regarding non-EEA countries will be included into IRIS and the EMA will communicate when such function is developed.

#### **References**

- Article 123 (2b) of Directive 2001/83/EC
- Articles 116 and Article 117(1) of Directive 2001/83/EC

### **23.11. Which information does the Agency publish about the marketing status of EU medicinal products? *Rev. Feb 2022***

Currently only information on withdrawn products are made public on the EMA website:

- The list of human medicinal products which have been withdrawn from the EU market (also referred as “list of withdrawn products”) includes both centrally and nationally authorised products for which marketing authorisations have been refused, revoked, suspended or withdrawn, due to grounds related to Article 116 and 117 (e.g. quality, efficacy or safety reasons). The list specifies whether the action has been initiated by the Marketing Authorisation Holder or whether it was imposed by the Competent Authorities (e.g. following a referral procedure at European level).
- For centrally-authorised products, the withdrawal or the expiry of the marketing authorisation is made publicly available on the EPAR webpage of the medicinal product on the EMA website, together with the reason(s) for such action.

As of July 2021, EMA uses the IRIS database to collect an overview of the marketing status of centrally-authorized products in the EU/EEA/UK(Northern Ireland) (at presentation level). Currently these marketing status data are only shared with the National Competent Authorities and the European Commission.

In the future, information on the availability of EU medicinal products might be made publicly available. The Agency will communicate in due course when such functionality becomes available.

#### **References**

- List of withdrawn medicinal products in accordance with Art. 123(4) of the Directive
- Article 123(4) of Directive 2001/83/EC, as amended

#### ***23.12. Is there an obligation to market a medicine which is authorised for a paediatric indication, following completion of an agreed paediatric investigation plan, and the product has already been marketed with other indications? NEW Jul 2021***

Please refer to Q3.1 and 3.3 of the Q&A on Paediatric Investigation Plans (Paediatric investigation plans: questions and answers on the European Medicines Agency's website).



## 24. Sunset clause monitoring

### 24.1. What is the sunset clause? *Rev. Jul 2021*

The so-called “sunset clause” is a provision leading to the cessation of the validity of the marketing authorisation if:

- the medicinal product is not placed on the market within three years of the authorisation being granted or,
- where a medicinal product previously placed on the market is no longer actually present on the market for three consecutive years.
- This provision applies to nationally-authorized products and centrally-authorized products.

For centrally-authorized products, the European Commission may grant exemptions on public health grounds and in exceptional circumstances if duly justified (see question *How to request an exemption to the sunset clause provision for centrally-authorized products?*).

#### References

- Article 14(4-6) of Regulation (EC) No 726/2004
- Article 24(4-6) of Directive 2001/83/EC, as amended
- Chapter 1 (section 2.4.2), The Rules governing Medicinal Products in the European Union, Notice to Applicants, Volume 2A

### 24.2. Does the sunset clause apply to existing medicinal products? *Rev. Jul 2021*

This provision applies prospectively to all centrally authorised medicinal products from the date of entry into force of the Regulation i.e. 20 November 2005.

Therefore, for centrally-authorized medicinal products for which a MA has been granted before 20 November 2005 and for which no presentation are marketed in the Union at this date, the three-year period which leads to cessation of the MA will start as of 20 November 2005.

#### References

- Document published by the Commission on 10 October 2005 - Application of the “Sunset Clause” in the Review of the Pharmaceutical Legislation to Medicinal Products Authorised before Directives 2004/27/EC and 2004/28/EC and Regulation (EC) No 726/2004 start to apply
- Chapter 1 (section 2.4.2), The Rules governing Medicinal Products in the European Union, Notice to Applicants, Volume 2A

### **24.3. What are the requirements to maintain a marketing authorisation for a centrally authorised medicinal product? *Rev. Jul 2021***

The marketing authorisation of a medicinal product will remain valid if at least one authorised presentation/pack-size is placed on the market in the Union (in at least one EU/EEA Member State).

The marketing authorisation of a centrally authorised medicinal product includes the initial marketing authorisation and all variations (e.g. additional presentations) and extensions (e.g. new strengths, new pharmaceutical forms) authorised for this specific medicinal product. This notion has been applied since the beginning of the centralised procedure and is reflected in the way the EU numbers are allocated to a specific centrally authorised medicinal product and all its presentations.

#### **References**

- Chapter 1 (section 2.4.2), The Rules governing Medicinal Products in the European Union, Notice to Applicants, Volume 2A

### **24.4. How the sunset clause is monitored by the EMA? *Rev. Jul 2021***

A three-year period without marketing of a medicinal product in the EEA can be encountered further to the granting of the marketing authorisation: when a medicinal product has never been marketed or, after marketing of a medicinal product has been completely stopped.

The term “no longer actually present on the market” should be understood in the same way as “ceases to be placed on the market”. Therefore, the sunset clause period in case of a complete marketing cessation of the product shall start from the last date of release into the distribution chain of the medicinal product. For definition and modalities of reporting of cessation, details are given in Marketing and cessation notification.

As of end of July 2021, the EMA uses the IRIS database to collect marketing status updates and monitor the sunset clause provision for centrally authorised medicinal products. This is done in view to notify the Commission when a three consecutive year period without marketing has elapsed and that the sunset clause provision should take effect.

The MAH should be aware of the timing with regard to the sunset clause period for their product in order to take any action, should they wish to retain their central marketing authorisation.

Please refer to the Q&A on marketing status updates and withdrawals for more information on the IRIS database and the reporting of actual marketing and marketing cessation.

#### **References**

- Article 13(4) and Article 14(4-6) of Regulation (EC) No 726/2004

### **24.5. When is the sunset timer ON/OFF? *Rev. Jul 2021***

The following situations can lead to the start of the sunset clause period (“ON”):

- Granting of the Marketing authorisation

At the time of the granting of the marketing authorisation, the medicinal product may not be immediately placed on the Union market. As a consequence, the sunset timer will start running from the granting of the marketing authorisation by the Commission or from the timepoint when the MAH can legally place the medicinal product on the market. (See also question 'In case of a protection period to be respected before placing the medicinal product on the market, when will the sunset clause period start counting?')

- A temporary or permanent cessation of placing on the market the medicinal product

The MAH is obliged to inform the Agency of any product cessation (see Q&A on Marketing and cessations and withdrawals). When there is no longer any presentation of the medicinal product placed on the Union market, the sunset timer will start running from the last date of release into the distribution chain of the medicinal product.

The following situations lead to the stop of the sunset clause period ("OFF"):

- Initial placing on the Union market

The sunset timer will stop running at the time of the first placing on the market of one presentation in one Member State.

- At the re-placing on the market after a temporary marketing cessation affecting all the authorised presentations of the medicinal product

As soon as a medicinal product is again placed on the Union market after a temporary cessation, the sunset timer will stop running at this date.

- Exemption

As soon as an exemption is granted by the Commission for a medicinal product, the sunset timer will be stopped.

#### ***24.6. In case of a protection period to be respected before placing the medicinal product on the market, when will the sunset clause period start?*** ***Rev. Jul 2021***

The determination of the start of the 3-year period from granting of the marketing authorisation should be the date when the medicinal product can be marketed by the marketing authorisation holder, taking into account, e.g. marketing protection and other protection rules which have to be respected.

For a medicinal product authorised after 20 November 2005, under the centralised procedure, the Commission Decision will, in most cases, initiate the monitoring of the sunset clause and trigger the 3-year period.

However, where data protection rules apply to reference products, the 3-year period for generic, hybrids and similar biological medicinal products will start as of the end of the 10 or 11-year of marketing protection period of the concerned reference medicinal product.

Furthermore, other protection rules might need to be respected. Such information is not known by the Agency. MAHs are therefore advised to inform the EMA Product Lead of the existence and if known, the expiry date of the other protection period(s) to be respected as appropriate. This should be notified within 60 days from the date of the granting of the MA.

## References

- Chapter 1 (section 2.4.2), The Rules governing Medicinal Products in the European Union, Notice to Applicants, Volume 2A
- Summary record of the 58th meeting of the Pharmaceutical Committee (1st June 2005) – published on the Commission website on 10 October 2005,
- Article 14(11) of Regulation (EC) No 726/2004
- Article 10(1) of Directive 2001/83/EC, as amended

### **24.7. How to request an exemption to sunset clause provision for centrally-authorized products? *Rev. Jul 2021***

The Commission may grant exemptions from the application of the sunset clause on public health grounds and in exceptional circumstances.

Exemptions can apply at any time of the central marketing authorisation life cycle (i.e. at the time of the marketing authorisation, during the marketing authorisation life, or approaching the expiry of the sunset clause period) depending on the type of exemptions.

At submission stage the following exemptions might be applicable:

- Medicinal products to be used in emergency situations, in response to public health threats duly recognised either by the WHO or by the Union (Decision No 2119/98/EC).
- Antimicrobial medicinal products such as antibiotics, antivirals and immunologicals (for active and passive immunisation) aimed at the prevention and/or treatment of disease caused by bio-terror agents in response to an emergency public health need.

It will be up to the MAH to justify why an exemption should apply based on public health grounds and in exceptional circumstances.

A request for an exemption including a justification should be notified to the European Commission, Health and Food Safety Directorate-General, Unit B5 (SANTE-PHARMACEUTICALS-B5@ec.europa.eu) with the EMA product lead, product mailbox and marketingstatus@ema.europa.eu in copy. Each justification will be considered on a case-by-case basis.

## References

- Article 14(6) of Regulation (EC) No 726/2004